

RediStart™

Solid State Starter

MX² Control

RB2, RC2, RX2E Models

User Manual

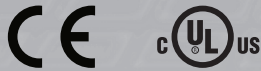

890034-01-02

August 2008

Software Version: 810023-01-08

Hardware Version: 300055-01-05

© 2008 Benshaw Inc.

Benshaw retains the right to change specifications and illustrations in text without prior notification. The contents of this document may not be copied without the explicit permission of Benshaw.



Important Reader Notice

Congratulations on the purchase of your new Benshaw RediStart MX² Solid State Starter. This manual contains the information to install and program the MX² Solid State Starter. The MX² is a standard version solid state starter. If you require additional features, please review the expanded feature set of the MX³ Solid State Starter on page 5.

This manual may not cover all of the applications of the RediStart MX². Also, it may not provide information on every possible contingency concerning installation, programming, operation, or maintenance specific to the RediStart MX² Series Starters.

The content of this manual will not modify any prior agreement, commitment or relationship between the customer and Benshaw. The sales contract contains the entire obligation of Benshaw. The warranty enclosed within the contract between the parties is the only warranty that Benshaw will recognize and any statements contained herein do not create new warranties or modify the existing warranty in any way.

Any electrical or mechanical modifications to Benshaw products without prior written consent of Benshaw will void all warranties and may also void cUL listing or other safety certifications, unauthorized modifications may also result in product damage operation malfunctions or personal injury.

Incorrect handling of the starter may result with an unexpected fault or damage to the starter. For best results on operating the RediStart MX² starter, carefully read this manual and all warning labels attached to the starter before installation and operation. Keep this manual on hand for reference.

Do not attempt to install, operate, maintain or inspect the starter until you have thoroughly read this manual and related documents carefully and can use the equipment correctly.

Do not use the starter until you have a full knowledge of the equipment, safety procedures and instructions.

This instruction manual classifies safety instruction levels under "WARNING" and "CAUTION".



Electrical Hazard that could result in injury or death.



Caution that could result in damage to the starter.

Highlight marking an important point in the documentation.

Please follow the instructions of both safety levels as they are important to personal safety.

DANGER

HAZARD OF ELECTRIC SHOCK, EXPLOSION, OR ARC FLASH

Only qualified personnel familiar with low voltage equipment are to perform work described in this set of instructions.

Apply appropriate personal protective equipment (PPE) and follow safe electrical work practices. See NFPA 70E.

Turn off all power before working on or inside equipment.

Use a properly rated voltage sensing device to confirm that the power is off.

Before performing visual inspections, tests, or maintenance on the equipment, disconnect all sources of electric power.

Assume that circuits are live until they have been completely de-energized, tested, and tagged. Pay particular attention to the design of the power system. Consider all sources of power, including the possibility of backfeeding.

Replace all devices, doors, and covers before turning on power to this equipment.

Failure to follow these instructions will result in death or serious injury.

TRADEMARK NOTICE



Benshaw and  are registered trademarks of Benshaw Incorporated.
UL is a trademark of Underwriters Laboratories, Incorporated.

Safety Precautions

Electric Shock Prevention

- While power is on or soft starter is running, do not open the front cover. You may get an electrical shock.
- This soft starter contains high voltage which can cause electric shock resulting in personal injury or loss of life.
- Be sure all AC power is removed from the soft starter before servicing.
- Do not connect or disconnect the wires to or from soft starter when power is applied.
- Make sure ground connection is in place.
- Always install the soft starter before wiring. Otherwise, you may get an electrical shock or be injured.
- Operate the switches with dry hands to prevent an electrical shock.
- Risk of Electric Shock - More than one disconnect switch may be required to de-energize the equipment before servicing.

Injury Prevention

- Service only by qualified personnel.
- Make sure power-up restart is off to prevent any unexpected operation of the motor.
- Make certain proper shield installation is in place.
- Apply only the voltage that is specified in this manual to the terminals to prevent damage.

Transportation and Installation

- Use proper lifting gear when carrying products, to prevent injury.
- Make certain that the installation position and materials can withstand the weight of the soft starter. Refer to the installation information in this manual for correct installation.
- If parts are missing, or soft starter is damaged, do not operate the RediStart MX².
- Do not stand or rest heavy objects on the soft starter, as damage to the soft starter may result.
- Do not subject the soft starter to impact or dropping.
- Make certain to prevent screws, wire fragments, conductive bodies, oil or other flammable substances from entering the soft starter.

Trial Run

- Check all parameters, and ensure that the application will not be damaged by a sudden start-up.

Emergency Stop

- To prevent the machine and equipment from hazardous conditions if the soft starter fails, provide a safety backup such as an emergency brake.

Disposing of the RediStart MX²

- Never dispose of electrical components via incineration. Contact your state environmental agency for details on disposal of electrical components and packaging in your area.

TABLE OF CONTENTS

Table of Contents

1 INTRODUCTION	2
1.1 Additional MX ³ Product Features.	5
2 TECHNICAL SPECIFICATIONS	10
2.1 General Information	10
2.2 Electrical Ratings	10
2.2.1 Terminal Points and Functions.	10
2.2.2 Measurements and Accuracies.	11
2.2.3 List of Motor Protection Features	11
2.2.4 Solid State Motor Overload.	12
2.2.5 CT Ratios	13
2.3 Starter Power Ratings	13
2.3.1 Standard Duty (350% for 30 sec) Ratings	14
2.3.2 Heavy Duty (500% current for 30 sec) Ratings.	15
2.3.3 Severe Duty (600% current for 30 sec) Ratings.	16
2.3.4 Inside Delta Connected Standard Duty (350% for 30 sec) Ratings.	17
2.3.5 RB2 Power Stack Ratings and Protection Requirements	18
2.3.6 Power Stack Input Ratings with Protection Requirements for Separate Bypass	19
2.3.7 Power Stack Input Ratings with Protection Requirements for RC No Bypass	20
2.3.8 RB2 Starter Control Power Requirements	21
2.3.9 RC2 Starter Control Power Requirements	21
2.4 Dimensions	22
2.4.1 RB2 Chassis with Integral Bypass	22
2.4.2 RC2 Chassis with no Bypass	24
2.5 Environmental Conditions.	25
2.6 Altitude Derating.	25
2.7 Approvals	26
2.8 Certificate of Compliance	26
3 INSTALLATION	28
3.1 Before You Start.	28
3.1.1 Inspection.	28
3.1.2 Installation Precautions	28
3.1.3 Safety Precautions	28
3.2 Installation Considerations	29
3.2.1 Site Preparation	29
3.2.2 EMC Installation Guidelines	29
3.2.3 Use of Power Factor Capacitors	29
3.2.4 Use of Electro-Mechanical Brakes	29
3.2.5 Reversing Contactor.	29
3.3 Mounting Considerations	30
3.3.1 Bypassed Starters	30
3.3.2 Non-Bypassed Starters	30
3.4 Wiring Considerations	31
3.4.1 Wiring Practices	31
3.4.2 Considerations for Control and Power Wiring.	31
3.4.3 Considerations for Signal Wiring	31
3.4.4 Meggering a Motor	31
3.4.5 High Pot Testing	31
3.5 Power and Control drawings for Bypassed and Non Bypassed Power Stacks	32

TABLE OF CONTENTS

3.6 Power Wiring	35
3.6.1 Recommended Incoming Line Protection	35
3.6.2 Recommended Wire Gauges	35
3.6.3 Power Wire Connections	35
3.6.4 Motor Lead Length	35
3.6.5 Compression Lugs	36
3.6.6 Torque Requirements for Power Wiring Terminations	37
3.7 Current Transformers	38
3.7.1 CT Mounting	38
3.7.2 CT Polarity	38
3.8 Control Card Layout	39
3.9 Control Wiring	40
3.9.1 Control Power	40
3.9.2 Output Relays	40
3.9.3 Digital Input Wiring Options	41
3.9.4 Analog Input	42
3.9.5 Analog Output	42
3.9.6 SW1 DIP Switch	43
3.10 Remote LCD Keypad/Display	43
3.10.1 Remote Display	43
3.10.2 Display Cutout	44
3.10.3 Installing Display	45
4 KEYPAD OPERATION	48
4.1 Introduction	48
4.2 Standard Keypad and Display	48
4.3 Viewing Parameter Values for the Standard Keypad	48
4.4 Changing Parameter Values	49
4.5 Messages Displayed	49
4.5.1 Power Up	49
4.5.2 Stopped	49
4.5.3 Running	50
4.5.4 Alarm Condition	50
4.5.5 Lockout Condition	50
4.5.6 Faulted Condition	50
4.5.7 Quick Meters	50
4.6 Restoring Factory Parameter Settings	51
4.7 Resetting a Fault	51
4.8 Emergency Overload Reset	51
4.9 2x16 Remote LCD Keypad	52
4.10 Description of the LEDs on the Keypad	52
4.11 Description of the Keys on the Remote LCD Keypad	53
4.12 Jump Code	54
4.13 Alphanumeric Display	54
4.13.1 Parameter Group Screens	55
4.13.2 Meter Pages	56
4.13.3 Fault Log Screen	56
4.13.4 Fault Screen	57
4.13.5 Lockout Screen	57
4.13.6 Alarm Screen	57
4.14 Procedure for Setting Data	58

TABLE OF CONTENTS

5	PARAMETER GROUPS	60
5.1	Introduction	60
5.2	LED and LCD Display Parameters Cross Reference	61
5.3	LED Display Parameters	62
5.4	LCD Display Parameters	66
5.4.1	Quick Start Group	66
5.4.2	Control Function Group	67
5.4.3	Protection Group	68
5.4.4	I/O Group	68
5.4.5	Function Group	70
5.4.6	LCD Fault Group	71
5.4.7	LED Fault Group	71
6	PARAMETER DESCRIPTION	74
6.1	Parameter Descriptions	74
7	THEORY OF OPERATION	132
7.1	Solid State Motor Overload Protection	132
7.1.1	Overview	132
7.1.2	Setting Up The MX ² Motor Overload	132
7.1.3	Motor Overload Operation	134
7.1.4	Current Imbalance / Negative Sequence Current Compensation	134
7.1.5	Harmonic Compensation	135
7.1.6	Hot / Cold Motor Overload Compensation	135
7.1.7	Separate Starting and Running Motor Overload Settings	136
7.1.8	Motor Cooling While Stopped	137
7.1.9	Motor Cooling While Running	138
7.1.10	Emergency Motor Overload Reset	138
7.2	Motor Service Factor	139
7.3	Acceleration Control	140
7.3.1	Current Ramp Settings, Ramps and Times	140
7.3.2	Programming A Kick Current	141
7.3.3	TruTorque Acceleration Control Settings and Times	141
7.3.4	Power Control Acceleration Settings and Times	143
7.3.5	Open Loop Voltage Ramps and Times	145
7.3.6	Dual Acceleration Ramp Control	147
7.4	Deceleration Control	149
7.4.1	Voltage Control Deceleration	149
7.4.2	TruTorque Deceleration	150
7.5	Braking Controls	151
7.5.1	DC Injection Braking, Standard Duty	152
7.5.2	DC Injection Braking, Heavy Duty	152
7.5.3	Braking Output Relay	152
7.5.4	Stand Alone Overload Relay for emergency ATL (Across The Line) operation	152
7.5.5	DC Injection Brake Wiring Example	153
7.5.6	DC Brake Timing	154
7.5.7	DC Injection Brake Enable and Disable Digital Inputs	155
7.5.8	Use of Optional Hall Effect Current Sensor	155
7.5.9	DC Injection Braking Parameters	156
7.6	Slow Speed Cyclo Converter	156
7.6.1	Operation	156
7.6.2	Slow Speed Cyclo Converter Parameters	157
7.7	Inside Delta Connected Starter	158
7.7.1	Line Connected Soft Starter	158
7.7.2	Inside Delta Connected Starter	159

TABLE OF CONTENTS

7.8	Wye Delta Starter	160
7.9	Across The Line (Full Voltage Starter)	163
7.10	Single Phase Soft Starter	164
7.11	Phase Control	165
7.11.1	Master/Slave Starter Configuration:	166
7.12	Current Follower	167
7.13	Start/Stop Control Logic	168
7.14	Hand/Off/Auto Selector Switch	169
7.15	Simplified I/O Schematics	170
7.16	Remote Modbus Communications	171
7.16.1	Supported Commands.	171
7.16.2	Modbus Register Addresses	171
7.16.3	Cable Specifications	171
8	TROUBLESHOOTING & MAINTENANCE	174
8.1	Safety Precautions	174
8.2	Preventative Maintenance	174
8.2.1	General Information.	174
8.2.2	Preventative Maintenance	174
8.3	General Troubleshooting Charts	175
8.3.1	Motor does not start, no output to motor.	175
8.3.2	During starting, motor rotates but does not reach full speed	176
8.3.3	Starter not accelerating as desired	176
8.3.4	Starter not decelerating as desired.	177
8.3.5	Motor stops unexpectedly while running	177
8.3.6	Metering incorrect.	178
8.3.7	Other Situations.	179
8.4	Fault Code Table	180
8.5	SCR Testing	187
8.5.1	Resistance.	187
8.5.2	Voltage	187
8.5.3	Integral Bypass.	187
8.6	Built In Self Test Functions	188
8.6.1	Standard BIST Tests:	188
8.6.2	Powered BIST Tests:	189
8.7	SCR Replacement.	191
8.7.1	Typical Stack Assembly.	191
8.7.2	SCR Removal.	191
8.7.3	SCR Installation	191
8.7.4	SCR Clamp	192
8.7.5	Tightening Clamp	192
8.7.6	Testing SCR.	192

TABLE OF CONTENTS

APPENDIX A ALARM CODES	194
APPENDIX B FAULT CODES	196
APPENDIX C SPARE PARTS	197
APPENDIX D EU DECLARATION OF CONFORMITY	198
APPENDIX E MODBUS REGISTER MAP	199
APPENDIX F PARAMETER TABLES	207

1

Introduction

1 - INTRODUCTION

Using this Manual

Layout

This manual is divided into 10 sections. Each section contains topics related to the section. The sections are as follows:

- Introduction
- Technical Information
- Installation
- Keypad Operation
- Parameters
- Parameter Description
- Applications
- Theory of Operation
- Troubleshooting & Maintenance
- Appendices

Symbols

There are 2 symbols used in this manual to highlight important information. The symbols appear as the following:



Electrical Hazard warns of situations in which a high voltage can cause physical injury, death and/or damage equipment.



Caution warns of situations in which physical injury and/damage to equipment may occur by means other than electrical.

Highlight mark an important point in the documentation.

DANGER

HAZARD OF ELECTRIC SHOCK, EXPLOSION, OR ARC FLASH

Only qualified personnel familiar with low voltage equipment are to perform work described in this set of instructions.

Apply appropriate personal protective equipment (PPE) and follow safe electrical work practices. See NFPA 70E.

Turn off all power before working on or inside equipment.

Use a properly rated voltage sensing device to confirm that the power is off.

Before performing visual inspections, tests, or maintenance on the equipment, disconnect all sources of electric power.

Assume that circuits are live until they have been completely de-energized, tested, and tagged. Pay particular attention to

the design of the power system. Consider all sources of power, including the possibility of backfeeding.

Replace all devices, doors, and covers before turning on power to this equipment.

Failure to follow these instructions will result in death or serious injury.

General Information

Benshaw offers its customers the following:

- Start-up services
- On-site training services
- Technical support
- Detailed documentation
- Replacement parts

⌘ **NOTE:** Information about products and services is available by contacting Benshaw, refer to page 4.

Start-Up Services

Benshaw technical field support personnel are available to customers with the initial start-up of the RediStart MX². Information about start-up services and fees are available by contacting Benshaw.

On-Site Training Services

Benshaw technical field support personnel are available to conduct on-site training on RediStart MX² operations and troubleshooting.

Technical Support

Benshaw technical support personnel are available (at no charge) to answer customer questions and provide technical support over the telephone. For more information about contacting technical support personnel, refer to page 4.

Documentation

Benshaw provides all customers with:

- Operations manual.
- Wiring diagram.

All drawings are produced in AutoCAD© format. The drawings are available on standard CD / DVD or via e-mail by contacting Benshaw.

On-Line Documentation

All RediStart MX² documentation is available on-line at <http://www.benshaw.com>.

Replacement Parts

Spare and replacement parts can be purchased from Benshaw Technical Support.

Software Number

This manual pertains to the software version numbers 810023-01-08.

Hardware Number

This manual pertains to the hardware version numbers 300055-01-05.

Publication History

See page 213.

Warranty

Benshaw provides a 1 year standard warranty with its starters. An extension to the 3 year warranty is provided when a Benshaw or Benshaw authorized service technician completes the installation and initial start up. The warranty data sheet must also be signed and returned. The cost of this service is not included in the price of the Benshaw soft starter and will be quoted specifically to each customers needs. All recommended maintenance procedures must be followed throughout the warranty period to ensure validity. This information is also available by going online to register at www.benshaw.com.

1 - INTRODUCTION

Contacting Benshaw

Contacting Benshaw

Information about Benshaw products and services is available by contacting Benshaw at one of the following offices:

Benshaw Inc. Corporate Headquarters

1659 E. Sutter Road
Glenshaw, PA 15116
Phone: (412) 487-8235
Tech Support: (800) 203-2416
Fax: (412) 487-4201

Benshaw High Point

EPC Division
645 McWay Drive
High Point, NC 27263
Phone: (336) 434-4445
Fax: (336) 434-9682

Benshaw Canada Controls Inc.

550 Bright Street East
Listowel, Ontario N4W 3W3
Phone: (519) 291-5112
Tech Support: (877) 236-7429 (BEN-SHAW)
Fax: (519) 291-2595

Benshaw Mobile

CSD Division
5821 Rangeline Road, Suite 202
Theodor, AL 36582
Phone: (251) 443-5911
Fax: (251) 443-5966

Benshaw West

14715 North 78th Way, Suite 600
Scottsdale, AZ 85260
Phone: (480) 905-0601
Fax: (480) 905-0757

Benshaw Pueblo

Trane Division
1 Jetway Court
Pueblo, CO 81001
Phone: (719) 948-1405
Fax: (719) 948-1445

Technical support for the RediStart MX² Series is available at no charge by contacting Benshaw's customer service department at one of the above telephone numbers. A service technician is available Monday through Friday from 8:00 a.m. to 5:00 p.m. EST.

⚠ **NOTE:** An on-call technician is available after normal business hours and on weekends by calling Benshaw and following the recorded instructions.

To help assure prompt and accurate service, please have the following information available when contacting Benshaw:

- Name of Company
- Telephone number where the caller can be contacted
- Fax number of caller
- Benshaw product name
- Benshaw model number
- Benshaw serial number
- Name of product distributor
- Approximate date of purchase
- Voltage of motor attached to Benshaw product
- FLA of motor attached to Benshaw product
- A brief description of the application

MX² & MX³ Product Comparison

1.1 Additional MX³ Product Features

The MX² is a standard solid state starter. If you require additional features, please review the expanded feature set of the MX³ Solid State Starter below. For the additional information on the MX³ Solid State Starter contact Benschaw.

	MX ³ Product Features
1	5 Additional Digital Inputs
2	3 Additional 5Amp, Form A Relays
3	Real Time Clock
4	Zero Sequence Ground Fault
5	16 RTD O/L Biasing (Platinum) Remote by RS-485
6	Motor PTC Feedback
7	Preset Slow Speeds (Cyclo-Convertor) 0.1 to 40% Motor Speed
8	99 Event Log
9	Backspin Timer
10	Starts per Hour
11	Time Between Starts
12	PORT (Power Outage Ride-Thru)
13	Squared and S Ramp Profiles
14	Speed Controlled Ramp with Tachometer Feedback

1 - INTRODUCTION

Interpreting Model Numbers

Figure 1: RediStart MX² Series Model Numbers

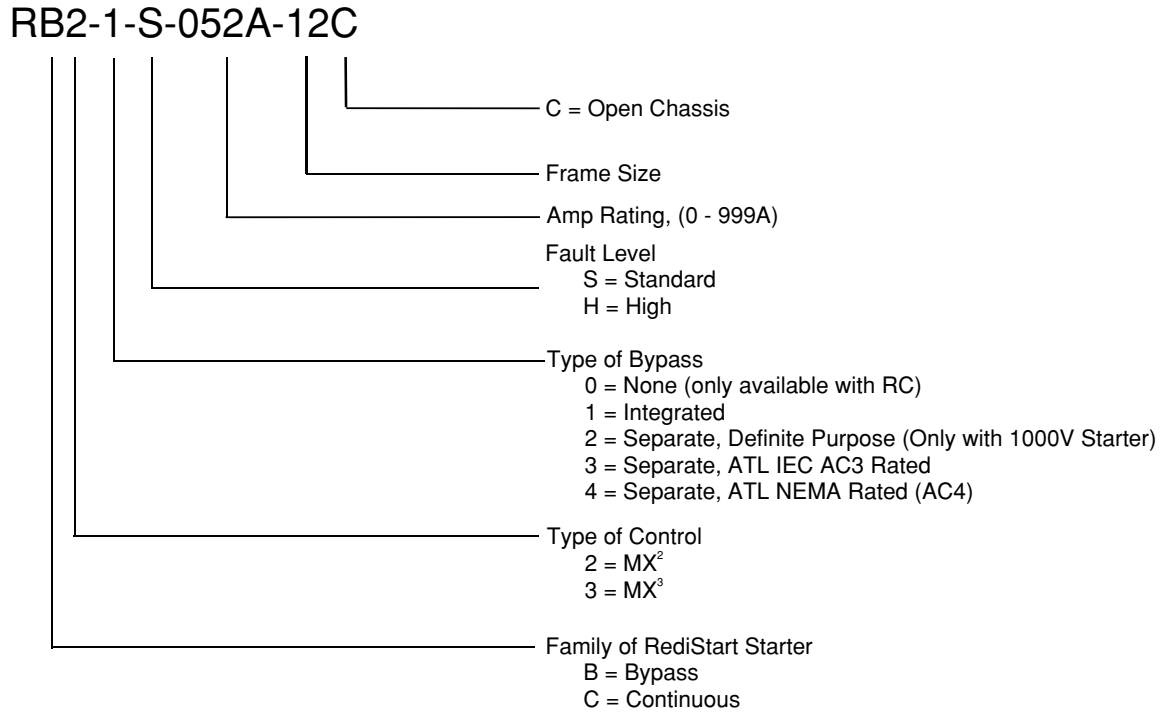

Example of Model Number: RX2-1S-361A-14C
A RediStart starter with bypass, MX² control, Integrated Bypass, Standard Fault, 361 Amp unit, Frame 14, open Chassis.

General Overview of a Reduced Voltage Starter

General Overview

The RediStart MX² motor starter is a microprocessor-controlled starter for single or three-phase motors. The starter can be custom designed for specific applications. A few of the features are:

- Solid state design.
- Reduced voltage starting and soft stopping.
- Closed-loop motor current control, power (kW) control, torque control.
- Programmable motor protection.
- Programmable operating parameters.
- Programmable metering.

Each starter can operate within applied line voltage and frequency values of 100VAC to 600VAC (optional 1000VAC) and 23 to 72Hz.

The starter can be programmed for any motor FLA and all of the common motor service factors. It enables operators to control both motor acceleration and deceleration. The RediStart MX² can also protect the motor and its load from damage that could be caused by incorrect phase order wiring.

The starter continually monitors the amount of current being delivered to the motor. This protects the motor from overheating or drawing excess current.

Features

The enhanced engineering features of the starter include:

- Multiple frame sizes
- Universal voltage operation
- Universal frequency operation
- Programmable motor overload multiplier
- Controlled acceleration and deceleration
- Phase rotation protection
- Regulated current control
- Electronic motor thermal overload protection
- Electronic over/under current protection
- Single phase protection
- Line-to-line current imbalance protection
- Stalled motor protection
- Programmable metering
- Passcode protected
- Programmable Relays
- Analog output with digital offset and span adjustment
- Analog input with digital offset and span adjustment
- Voltage and Current Accuracy of 3%
- Slow Speed (Cyclo Conversion) 7.1% & 14.3% forward and reverse
- Motor winding (Anti-Condensation)
- Anti-windmilling brake
- DC Injection Braking

1 - INTRODUCTION

NOTES:

2 Technical Specifications

2 - TECHNICAL SPECIFICATIONS

Technical Specifications

2.1 General Information

The physical specifications of the starter vary depending upon its configuration. The applicable motor current determines the configuration and its specific application requirements.

Specifications are subject to change without notice.

This document covers the control electronics and several power sections:

- MX² control card
- RB Power Stacks with Bypass, Integral and Separate
- RC Power Stacks, Continuous operation, NO bypass

Electrical Ratings

2.2 Electrical Ratings

2.2.1 Terminal Points and Functions

Table 1: Terminals

Function	Terminal Block	Terminal Number	Description
Control Power	TB1	G, ground N, 120VAC neutral N, 120VAC neutral L, 120VAC line L, 120VAC line	96 – 144 VAC input, 50/60 Hz 45VA required for control card
Relay 1 (R1)	TB2	NO1: Normally Open Contact RC1: Common NC1: Normally Closed Contact	Relay Output, SPDT form C NO Contact (resistive) NC Contact(resistive) 5A at 250VAC 3A at 250VAC 5A at 125VAC 3A at 125VAC 5A at 30VDC 3A at 30VDC 1250VA 750VA
Relay 2 (R2)	TB2	NO2: Normally Open Contact RC2: Common Contact NC2: Normally Closed Contact	Relay Output, SPDT form C NO Contact (resistive) NC Contact(resistive) 5A at 250VAC 3A at 250VAC 5A at 125VAC 3A at 125VAC 5A at 30VDC 3A at 30VDC 1250VA 750VA
Relay 3 (R3)	TB2	NO3: Normally Open Contact RC3: Common Contact NC3: Normally Closed Contact	10A at 250VAC 10A at 125VAC 10A at 30VDC 2500VA
Digital Inputs	TB3	1: Start 2: DI1 3: DI2 4: DI3 5: Common	120VAC digital input 2500V optical isolation 4mA current draw Off: 0-35VAC On: 60-120VAC
Serial Comm	TB4	1: B+ 2: A- 3: COM	Modbus RTU serial communication port. RS-485 interface 19.2k baud maximum 1500V Isolation
Analog I/O	TB5	1: Ain Power 2: Ain + 3: Ain - 4: Common 5: Aout 6: Common 7: Shield	Input: Voltage or Current Voltage: 0-10VDC, 67K impedance Current: 0-20mA, 500 impedance Output: Voltage or Current Voltage: 0-10VDC, 120mA maximum Current: 0-20mA, 500 load maximum
Display	RJ45		Door Mounted Display Connector

2 - TECHNICAL SPECIFICATIONS

Table 1: Terminals

Function	Terminal Block	Terminal Number	Description
SCR	J6 to J11	1: Gate 2: Cathode	SCR gate Connections
Phase C.T.	J12	1: CT1 2: CT1 3: CT2 4: CT2 5: CT3 6: CT3	See CT Connector

Wire Gauge: The terminals can support 1- 14 AWG wire or 2-16 AWG wire or smaller.

Torque Rating: The terminals on the control card have a torque rating of 5.0-inch lb. or 0.56Nm. This MUST be followed or damage will occur to the terminals.

Refer to the Control Card Layout on page 39.

2.2.2 Measurements and Accuracies

Table 2: Measurements and Accuracies

Internal Measurements																									
CT Inputs	Conversion: True RMS, Sampling @ 1.562kHz Range: 1-6400A																								
Line Voltage Inputs	Conversion: True RMS, Sampling @ 1.562kHz Range: 100VAC to 1000VAC 23 to 72 Hz																								
Metering	<table style="width: 100%; border-collapse: collapse;"> <tr> <td style="padding-left: 20px;">Current</td> <td>0 – 40,000 Amps ± 3%</td> </tr> <tr> <td style="padding-left: 20px;">Voltage</td> <td>0 – 1250 Volts ± 3%</td> </tr> <tr> <td style="padding-left: 20px;">Watts</td> <td>0 – 9,999 MW ± 5%</td> </tr> <tr> <td style="padding-left: 20px;">Volts-Amps</td> <td>0 – 9,999 MVA ± 5%</td> </tr> <tr> <td style="padding-left: 20px;">Watt-Hours</td> <td>0 – 10,000 MWh ± 5%</td> </tr> <tr> <td style="padding-left: 20px;">PF</td> <td>-0.01 to +0.01 (Lag & Lead) ± 5%</td> </tr> <tr> <td style="padding-left: 20px;">Line Frequency</td> <td>23 – 72 Hz ± 0.1 Hz</td> </tr> <tr> <td style="padding-left: 20px;">Ground Fault</td> <td>5 – 100% FLA ± 5% (Machine Protection)</td> </tr> <tr> <td style="padding-left: 20px;">Run Time</td> <td>± 3 seconds per 24 hour period</td> </tr> <tr> <td style="padding-left: 20px;">Analog Input</td> <td>Accuracy ± 3% of full scale (10 bit)</td> </tr> <tr> <td style="padding-left: 20px;">Analog Output</td> <td>Accuracy ±2% of full scale (12 bit)</td> </tr> <tr> <td></td> <td>⚠ NOTE: Percent accuracy is percent of full scale of the given ranges, Current = Motor FLA, Voltage = 1000V, Watts/Volts-Amps/Watt-Hours = Motor & Voltage range</td> </tr> </table>	Current	0 – 40,000 Amps ± 3%	Voltage	0 – 1250 Volts ± 3%	Watts	0 – 9,999 MW ± 5%	Volts-Amps	0 – 9,999 MVA ± 5%	Watt-Hours	0 – 10,000 MWh ± 5%	PF	-0.01 to +0.01 (Lag & Lead) ± 5%	Line Frequency	23 – 72 Hz ± 0.1 Hz	Ground Fault	5 – 100% FLA ± 5% (Machine Protection)	Run Time	± 3 seconds per 24 hour period	Analog Input	Accuracy ± 3% of full scale (10 bit)	Analog Output	Accuracy ±2% of full scale (12 bit)		⚠ NOTE: Percent accuracy is percent of full scale of the given ranges, Current = Motor FLA, Voltage = 1000V, Watts/Volts-Amps/Watt-Hours = Motor & Voltage range
Current	0 – 40,000 Amps ± 3%																								
Voltage	0 – 1250 Volts ± 3%																								
Watts	0 – 9,999 MW ± 5%																								
Volts-Amps	0 – 9,999 MVA ± 5%																								
Watt-Hours	0 – 10,000 MWh ± 5%																								
PF	-0.01 to +0.01 (Lag & Lead) ± 5%																								
Line Frequency	23 – 72 Hz ± 0.1 Hz																								
Ground Fault	5 – 100% FLA ± 5% (Machine Protection)																								
Run Time	± 3 seconds per 24 hour period																								
Analog Input	Accuracy ± 3% of full scale (10 bit)																								
Analog Output	Accuracy ±2% of full scale (12 bit)																								
	⚠ NOTE: Percent accuracy is percent of full scale of the given ranges, Current = Motor FLA, Voltage = 1000V, Watts/Volts-Amps/Watt-Hours = Motor & Voltage range																								

2.2.3 List of Motor Protection Features

- ANSI 19 – Reduced Voltage Start
- ANSI 27 / 59 – Adjustable over/under voltage protection (Off or 1 to 40%, time 0.1 to 90.0 sec. in 0.1 sec. intervals, independent over and under voltage levels)
- ANSI 37 – Undercurrent detection (Off or 5 to 100% and time 0.1 to 90.0 sec. in 0.1 sec. intervals)
- ANSI 46 – Current imbalance detection (Off or 5 to 40%)
- ANSI 47 – Phase rotation (selectable ABC, CBA, Insensitive, or Single Phase)
- ANSI 48 – Adjustable up-to-speed / stall timer (1 to 900 sec. in 1 sec. intervals)
- ANSI 50 – Instantaneous electronic overcurrent trip
- ANSI 51 – Electronic motor overload (Off, class 1 to 40, separate starting and running curves available)
- ANSI 51 – Overcurrent detection (Off or 50 to 800% and time 0.1 to 90.0 sec. in 0.1 sec. intervals)
- ANSI 51G – Residual Ground fault detection (Off or 5 to 100% of motor FLA)
- ANSI 74 – Alarm relay output available
- ANSI 81 – Over / Under Frequency
- ANSI 86 – Overload lockout
- Single Phase Protection
- Shorted SCR detection
- Mechanical Jam

2 - TECHNICAL SPECIFICATIONS

2.2.4 Solid State Motor Overload

The MX² control has an advanced I²t electronic motor overload (OL) protection function. For optimal motor protection the MX² control has forty standard NEMA style overload curves available for use. Separate overloads can be programmed, one for acceleration and another for normal running operation. The overloads can be individual, the same or completely disabled if necessary. The MX² motor overload function also implements a NEMA based current imbalance overload compensation, user adjustable hot and cold motor compensation and user adjustable exponential motor cooling.

Figure 2: Commonly Used Overload Curves

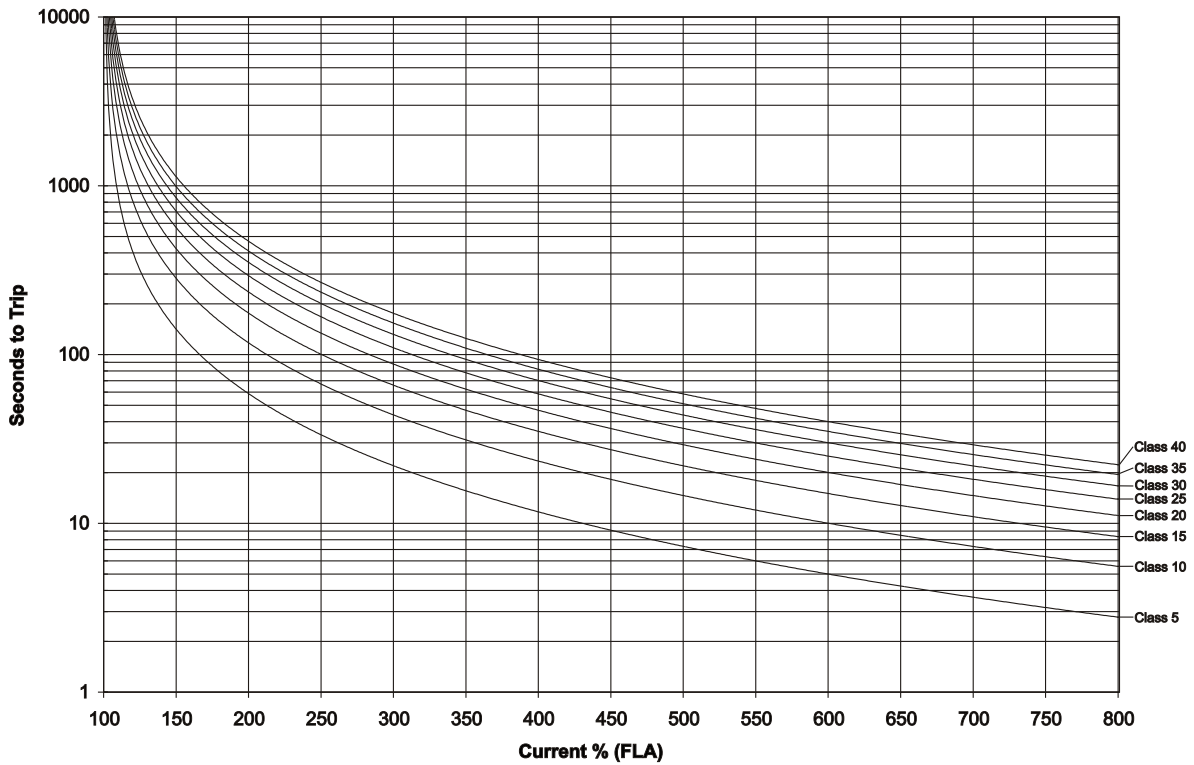

The motor overload will NOT trip when the current is less than motor Full Load Amps (FLA) * Service Factor (SF).

The motor overload "pick up" point current is at motor Full Load Amps (FLA) * Service Factor (SF).

The motor overload trip time will be reduced when there is a current imbalance present.

⚠ **NOTE:** Refer to Theory of Operation, section 7.1 on page 132 for more motor overload details and a larger graph.

Refer to <http://www.benshaw.com/olcurves.html> for an automated overload calculator.

2 - TECHNICAL SPECIFICATIONS

2.2.5 CT Ratios

Table 3: CT Ratios

CT Ratio	Minimum FLA (A rms)	Maximum FLA (A rms)
72:1 (4 wraps 288:1)	4	16
96:1 (3 wraps 288:1)	5	21
144:1 (2 wraps 288:1)	8	32
288:1	15	64
864:1	45	190
2640:1	135	590
3900:1	200	870
5760:1	295	1285
8000:1	410	1800
14400:1 (CT-CT combination)	740	3200
28800:1 (CT-CT combination)	1475	6400

⚠ NOTE: See P78/FUN 03 (CT Ratio) parameter on page 126 for more information.

Starter Power Ratings

2.3 Starter Power Ratings

Each RB2 model starter is rated for three different starting duties. For example, a starter can operate a:

300HP motor for a standard duty start (350% for 30 seconds)

Or

200HP for a heavy duty start (500% for 30 seconds)

Or

150HP motor for a severe duty start (600% for 30 seconds)

Or

450HP motor when connected to the inside delta of a motor for a standard duty start (350% for 30 seconds)

2 - TECHNICAL SPECIFICATIONS

2.3.1 Standard Duty (350% for 30 sec) Ratings

Table 4: Standard Duty Horsepower Ratings

Standard Duty (350% current for 30 seconds, 115% Continuous)						
MODEL NUMBER	NOMINAL AMPS	HORSEPOWER RATING				
		200-208V	230-240V	380-400V	440-480V	575-600V
RB2-1-S-027A-11C	27	7.5	10	15	20	25
RB2-1-S-040A-11C	40	10	15	25	30	40
RB2-1-S-052A-12C	52	15	20	30	40	50
RB2-1-S-065A-12C	65	20	25	40	50	60
RB2-1-S-077A-13C	77	25	30	40	60	75
RB2-1-S-096A-13C	96	30	40	50	75	100
RB2-1-S-125A-14C	125	40	50	75	100	125
RB2-1-S-156A-14C	156	50	60	75	125	150
RB2-1-S-180A-14C	180	60	75	100	150	200
RB2-1-S-180A-15C	180	60	75	100	150	200
RB2-1-S-240A-15C	240	75	100	150	200	250
RB2-1-S-302A-15C	302	100	125	150	250	300
RB2-1-S-361A-16C	361	125	150	200	300	400
RB2-1-S-414A-17C	414	150	150	250	350	400
RB2-1-S-477A-17C	477	150	200	300	400	500
RB2-1-S-515A-17C	515	200	200	300	450	500
RB2-1-S-590A-18C	590	200	250	350	500	600
RB2-1-S-720A-19C	720	250	300	400	600	700
RB2-1-S-838A-20C	838	300	350	500	700	800

⚠ **NOTE:** Do not exceed Class 10 overload setting.

2 - TECHNICAL SPECIFICATIONS

2.3.2 Heavy Duty (500% current for 30 sec) Ratings

Table 5: Heavy Duty Horsepower Ratings

Heavy Duty (500% current for 30 seconds, 125% Continuous)						
MODEL NUMBER	NOMINAL AMPS	HORSEPOWER RATING				
		200-208V	230-240V	380-400V	440-480V	575-600V
RB2-1-S-027A-11C	24	7.5	10	15	20	25
RB2-1-S-040A-11C	40	10	15	25	30	40
RB2-1-S-052A-12C	54	15	20	30	40	50
RB2-1-S-065A-12C	54	15	20	30	40	50
RB2-1-S-077A-13C	54	15	20	30	40	50
RB2-1-S-096A-13C	96	30	40	50	75	100
RB2-1-S-125A-14C	125	40	50	75	100	125
RB2-1-S-156A-14C	125	40	50	75	100	125
RB2-1-S-180A-14C	125	40	50	75	100	125
RB2-1-S-180A-15C	180	60	75	100	150	200
RB2-1-S-240A-15C	215	60	75	125	150	200
RB2-1-S-302A-15C	215	60	75	125	150	200
RB2-1-S-361A-16C	252	75	100	150	200	250
RB2-1-S-414A-17C	372	125	150	200	300	400
RB2-1-S-477A-17C	372	125	150	200	300	400
RB2-1-S-515A-17C	372	125	150	200	300	400
RB2-1-S-590A-18C	551	200	200	300	450	500
RB2-1-S-720A-19C	623	200	250	350	500	600
RB2-1-S-838A-20C	623	200	250	350	500	600

⌘ **NOTE:** Do not exceed Class 20 overload setting.

2 - TECHNICAL SPECIFICATIONS

2.3.3 Severe Duty (600% current for 30 sec) Ratings

Table 6: Severe Duty Horsepower Ratings

Severe Duty (600% current for 30 seconds 125% Continuous)						
MODEL NUMBER	NOMINAL AMPS	HORSEPOWER RATING				
		200-208V	230-240V	380-400V	440-480V	575-600V
RB2-1-S-027A-11C	24	5	7.5	10	15	20
RB2-1-S-040A-11C	40	10	10	20	30	40
RB2-1-S-052A-12C	45	10	15	25	30	40
RB2-1-S-065A-12C	45	10	15	25	30	40
RB2-1-S-077A-13C	45	10	15	25	30	40
RB2-1-S-096A-13C	77	25	30	40	60	75
RB2-1-S-125A-14C	105	30	40	60	75	100
RB2-1-S-156A-14C	105	30	40	60	75	100
RB2-1-S-180A-14C	105	30	40	60	75	100
RB2-1-S-180A-15C	180	50	60	100	125	150
RB2-1-S-240A-15C	180	50	60	100	125	150
RB2-1-S-302A-15C	180	50	60	100	125	150
RB2-1-S-361A-16C	210	60	75	125	150	200
RB2-1-S-414A-17C	310	100	125	150	250	300
RB2-1-S-477A-17C	310	100	125	150	250	300
RB2-1-S-515A-17C	310	100	125	150	250	300
RB2-1-S-590A-18C	515	150	200	300	450	500
RB2-1-S-720A-19C	515	150	200	300	450	500
RB2-1-S-838A-20C	515	150	200	300	450	500

⚠ **NOTE:** Do not exceed Class 30 overload setting.

2 - TECHNICAL SPECIFICATIONS

2.3.4 Inside Delta Connected Standard Duty (350% for 30 sec) Ratings

Table 7: Inside Delta Standard Duty Horsepower Ratings

INSIDE DELTA Std Duty (350% start for 30 seconds 115% Continuous)						
MODEL NUMBER	NOMINAL AMPS	HORSEPOWER RATING				
		200-208V	220-240V	380-415V	440-480V	575-600V
RB2-1-S-125A-14C	180	60	75	100	150	200
RB2-1-S-156A-14C	240	75	100	150	200	250
RB2-1-S-180A-14C	279	75	100	150	200	250
RB2-1-S-180A-15C	279	75	100	150	200	250
RB2-1-S-240A-15C	361	125	150	200	300	400
RB2-1-S-302A-15C	414	150	150	250	350	400
RB2-1-S-361A-16C	515	200	150	250	450	400
RB2-1-S-414A-17C	590	200	250	350	500	600
RB2-1-S-477A-17C	720	250	300	400	600	700
RB2-1-S-515A-17C	800	250	300	500	600	700
RB2-1-S-590A-18C	838	300	350	500	700	800
RB2-1-S-720A-19C	1116	300	350	700	900	800
RB2-1-S-838A-20C	1300	400	500	800	1000	1200

⚠ **NOTE:** Do not exceed Class 10 overload setting.

2 - TECHNICAL SPECIFICATIONS

2.3.5 RB2 Power Stack Ratings and Protection Requirements

Model Number	Nominal Current (A)	115% Current Rating (A)	Nominal Current (A) Inside Delta	115% Current (A) Inside Delta	Unit Withstand Rating (kA) Std. Fault ⁵	Unit Withstand Rating (kA) High. Fault ⁵	Connection Type		Allowable Fuse Class	Maximum Fuse Size Current (A)	Maximum Circuit Breaker Trip Rating (A)	Running Watt Loss, After Bypassed (W)
							Line	Load				
RB_1_027A11C	27	31	-	48	5	5	Power Block ¹	Bus Tab ³	J/T/RK1/RK5	45/70*	60/100*	49
RB_1_040A11C	40	46	-	71	5	5	Power Block ¹	Bus Tab ³	J/T/RK1/RK5	70/100*	100/150*	49.8
RB_1_052A12C	52	60	-	93	10	10	Power Block ²	Bus Tab ³	J/T/RK1/RK5	90/125*	125/200*	51
RB_1_065A12C	65	75	-	116	10	10	Power Block ²	Bus Tab ³	J/T/RK1/RK5	110/175*	150/250*	53.7
RB_1_077A13C	77	89	-	137	10	10	Bus Tab ³	Bus Tab ³	J/T/RK1/RK5	125/200*	175/300*	56
RB_1_096A13C	96	110	-	171	10	10	Bus Tab ³	Bus Tab ³	J/T/RK1/RK5	150/250*	225/350*	59
RB_1_125A14C	125	144	194	223	18	30	Bus Tab ⁴	Bus Tab ⁴	J/T/RK1/RK5	200/300*	300/450*	62
RB_1_156A14C	156	179	242	278	18	30	Bus Tab ⁴	Bus Tab ⁴	J/T/RK1/RK5	250/400*	350/600*	66
RB_1_180A14C	180	207	279	321	18	30	Bus Tab ⁴	Bus Tab ⁴	J/T/RK1/RK5	300/450*	450/700*	71
RB_1_180A15C	180	207	279	321	30	65	Bus Tab ⁴	Bus Tab ⁴	J/T/RK1/RK5	300/450*	450/700*	71
RB_1_240A15C	240	276	372	428	30	65	Bus Tab ⁴	Bus Tab ⁴	J/T/RK1/RK5	400/600*	600/900*	75
RB_1_302A15C	302	347	468	538	30	65	Bus Tab ⁴	Bus Tab ⁴	J/T/RK1/RK5/L	500/800*	700/1100*	82
RB_1_361A16C	361	415	560	643	30	65	Bus Tab ⁴	Bus Tab ⁴	J/T/RK1/RK5/L	600/900*	900/1300*	92
RB_1_414A17C	414	476	642	738	42	65	Bus Tab ⁴	Bus Tab ⁴	L/T	700/1100*	1000/1600*	103
RB_1_477A17C	477	549	739	850	42	65	Bus Tab ⁴	Bus Tab ⁴	L/T	800/1200*	1200/1800*	120
RB_1_515A17C	515	592	798	918	42	65	Bus Tab ⁴	Bus Tab ⁴	L	900/1300*	1300/2000*	140
RB_1_590A18C	590	679	915	1052	42	65	Bus Tab ⁴	Bus Tab ⁴	L	1000/1600*	1400/2000*	165
RB_1_720A18C	720	828	1116	1283	42	65	Bus Tab ⁴	Bus Tab ⁴	L	1200/1800*	1800/2500*	205
RB_1_838A19C	838	964	1299	1494	42	65	Bus Tab ⁴	Bus Tab ⁴	L	1400/2000*	2000/3000*	245

* Rating for Inside Delta Application

1 Power Block wire size #12-#4awg

2 Power Block wire size #10-#1awg

3 Bus Tab with 1 hole 1/4" diameter

4 Bus Tab with NEMA 2 hole pattern 1/2" diameter 3/4" apart as defined by NEMA Standard CCI

5 For higher kAIC ratings, consult factory

2 - TECHNICAL SPECIFICATIONS

2.3.6 Power Stack Input Ratings with Protection Requirements for Separate Bypass

Model Number	Nominal Current (A)	115% Current Rating (A)	Nominal Current (A) Inside Delta	115% Current (A) Inside Delta	AC3 Unit Withstand Fault Rating (KA) ⁵	NEMA (AC4) Unit Withstand Fault Rating (KA) ⁵	Connection Type		Allowable Fuse Class	Maximum Fuse Size Current (A)	Maximum Circuit Breaker Trip Rating (A)	Running Watt Loss, After Bypassed (W)
							Line	Load				
RB_2_027A11C	27	31	-	-	5	5	Power Block ¹	Bus Tab ³	J/T/RK1/RK5	45/70*	60/100*	49
RB_2_040A11C	40	46	-	-	5	10	Power Block ¹	Bus Tab ³	J/T/RK1/RK5	70/100*	100/150*	49.8
RB_2_052A12C	52	60	-	-	5	10	Power Block ²	Bus Tab ³	J/T/RK1/RK5	90/125*	125/200*	51
RB_2_065A12C	65	75	-	-	10	10	Power Block ²	Bus Tab ³	J/T/RK1/RK5	110/175*	150/250*	53.7
RB_2_077A13C	77	89	-	-	10	10	Bus Tab ³	Bus Tab ³	J/T/RK1/RK5	125/200*	175/300*	56
RB_2_096A13C	96	110	-	-	10	10	Bus Tab ³	Bus Tab ³	J/T/RK1/RK5	150/250*	225/350*	59
RB_2_125A14C	125	144	194	223	10	10	Bus Tab ⁴	Bus Tab ⁴	J/T/RK1/RK5	200/300*	300/450*	62
RB_2_156A14C	156	179	242	278	10	18	Bus Tab ⁴	Bus Tab ⁴	J/T/RK1/RK5	250/400*	350/600*	66
RB_2_180A14C	180	207	279	321	10	18	Bus Tab ⁴	Bus Tab ⁴	J/T/RK1/RK5	300/450*	450/700*	71
RB_2_180A15C	180	207	279	321	10	18	Bus Tab ⁴	Bus Tab ⁴	J/T/RK1/RK5	300/450*	450/700*	71
RB_2_240A15C	240	276	372	428	18	18	Bus Tab ⁴	Bus Tab ⁴	J/T/RK1/RK5	400/600*	600/900*	75
RB_2_302A15C	302	347	468	538	18	30	Bus Tab ⁴	Bus Tab ⁴	J/T/RK1/RK5/L	500/800*	700/1100*	82
RB_2_361A16C	361	415	560	643	30	30	Bus Tab ⁴	Bus Tab ⁴	J/T/RK1/RK5/L	600/900*	900/1300*	92
RB_2_414A17C	414	476	642	738	30	30	Bus Tab ⁴	Bus Tab ⁴	L/T	700/1100*	1000/1600*	103
RB_2_477A17C	477	549	739	850	30	30	Bus Tab ⁴	Bus Tab ⁴	L/T	800/1200*	1200/1800*	120
RB_2_515A17C	515	592	798	918	30	30	Bus Tab ⁴	Bus Tab ⁴	L	900/1300*	1300/2000*	140
RB_2_590A18C	590	679	915	1052	30	30	Bus Tab ⁴	Bus Tab ⁴	L	1000/1600*	1400/2000*	165
RB_2_720A18C	720	828	1116	1283	30	30	Bus Tab ⁴	Bus Tab ⁴	L	1200/1800*	1800/2500*	205
RB_2_838A19C	838	964	1299	1494	Consult Factory	Consult Factory	Bus Tab ⁴	Bus Tab ⁴	L	1400/2000*	2000/3000*	245
* Rating for Inside Delta Application												
1 Power Block wire size #12-#4awg												
2 Power Block wire size #10-#1awg												
3 Bus Tab with 1 hole 1/4" diameter												
4 Bus Tab with NEMA 2 hole pattern 1/2" diameter 3/4" apart as defined by NEMA Standard CCI												
5 For higher kAIC ratings, consult factory												

2 - TECHNICAL SPECIFICATIONS

2.3.7 Power Stack Input Ratings with Protection Requirements for RC No Bypass

Model Number	Nominal Current (A)	125% Current	Unit Withstand Fault Rating (kA) ⁴	Connection Type		Current Limiting Circuit Breaker Protected Rating				Current Limiting Circuit Breaker Protected Rating			Running Watt Loss, After Bypassed (W)
				Line	Load	Allowable Fuse Class	Maximum Fuse Current (A)	Short Circuit Rating	Catalog Number	Trip Plug	Short Circuit Rating		
RC_0_027A31C	27	33.75	42	Power Block ¹	Power Block ¹	J/600V AC T/RK1	40 60	100kA 50kA	CED63B	60A	42kA	110	
RC_0_040A31C	40	50	42	Power Block ¹	Power Block ¹	J/600V AC T/RK1	60 100	100kA 50kA	CED63B	60A	42kA	145	
RC_0_052A31C	52	65	42	Power Block ¹	Power Block ¹	J/600V AC T/RK1	60 100	100kA 50kA	CED63B	100A	42kA	175	
RC_0_065A32C	65	81	42	Power Block ²	Power Block ²	J/600V AC T/RK1	225	100kA	CED63B	100A	42kA	210	
RC_0_077A32C	77	96	42	Power Block ²	Power Block ²	J/600V AC T/RK1	225	100kA	CED63B	125A	42kA	240	
RC_0_096A33C	96	120	42	Power Block ³	Power Block ³	J/600V AC T/RK1	225	100kA	CFD63B	225A	42kA	285	
RC_0_124A34C	124	155	42	Power Block ³	Power Block ³	J/600V AC T/RK1	225	100kA	CFD63B	225A	42kA	360	
RC_0_125A34C	125	155	42	Bus Tab	Bus Tab	J/600V AC T/RK1	350	100kA	CFD63B	225A	42kA	360	
RC_0_156A34C	156	195	42	Bus Tab	Bus Tab	J/600V AC T/RK1	400	100kA	CFD63B	225A	65kA	435	
RC_0_180A35C	180	225	42	Bus Tab	Bus Tab	J/600V AC T/RK1	400	100kA	CFD63B	250A	65kA	495	
RC_0_240A35C	240	300	42	Bus Tab	Bus Tab	J/600V AC T/RK1	600	100kA	CFD63B	400A	65kA	645	
RC_0_302A35C	302	377	42	Bus Tab	Bus Tab	J/600V AC T/RK1	800	100kA	CFD63B	400A	65kA	800	
RC_0_361A35C	361	421	42	Bus Tab	Bus Tab	J/600V AC T/RK1	800	100kA	CJD63B CLD63b	400A 600A	65kA	950	
RC_0_477A35C	477	596	42	Bus Tab	Bus Tab	J/600V AC T/RK1	800	100kA	CJD63B CLD63b	400A 600A	65kA	1240	
RC_0_590A36C	590	737	42	Bus Tab	Bus Tab	L	1400	100kA	CND63B CND63b	800A 1200a	85kA	1520	
RC_0_720A36C	720	900	42	Bus Tab	Bus Tab	L	1600	100kA	CND63B CND63b	800A 1200A	85kA	1845	
RC_0_840A36C	840	1050	85	Bus Tab	Bus Tab	L	1600	100kA	CND63B CND63b	800A 1200A	85kA	2145	
RC_0_960A37C	960	1200	85	Bus Tab	Bus Tab	L	1600 2000	100kA 50kA	HPD63F160	1200 – 1600A	85kA	2445	
RC_0_1080A-37C	1080	1350	85	Bus Tab	Bus Tab	L	1600 2000	100kA 50kA	HPD63F160	1200 – 1600A	85kA		
RC_0_1200KA38C	1200	1440	85	Bus Tab	Bus Tab	L	1600 2000	100kA 50kA	HPD63F160	1200 – 1600A	85kA	3045	

1 Power Block wire size #6 awg max

2 Power Block wire size #2 awg max

3 Power Block wire size #2/0 max

4 For higher kAIC ratings, consult factory

2 - TECHNICAL SPECIFICATIONS

2.3.8 RB2 Starter Control Power Requirements

Table 8: RB2 Starter CPT VA Requirements

Model Number	Power Required (VA)	Recommended Min. TX size	Model Number	Power Required (VA)	Recommended Min. TX size
RB2-1-S-027A-11C	74	75	RB2-1-S-240A-15C	243	250
RB2-1-S-040A-11C	74	75	RB2-1-S-302A-15C	243	250
RB2-1-S-052A-12C	111	125	RB2-1-S-361A-16C	243	250
RB2-1-S-065A-12C	111	125	RB2-1-S-414A-17C	441	450
RB2-1-S-077A-13C	111	125	RB2-1-S-477A-17C	441	450
RB2-1-S-096A-13C	111	125	RB2-1-S-515A-17C	441	450
RB2-1-S-125A-14C	131	150	RB2-1-S-590A-18C	441	450
RB2-1-S-156A-14C	243	250	RB2-1-S-720A-19C	441	450
RB2-1-S-180A-14C	243	250	RB2-1-S-838A-20C	243	250

2.3.9 RC2 Starter Control Power Requirements

Table 9: RC2 Starter CPT VA Requirements

Model Number	Power Required (VA)	Recommended Min. TX size	Model Number	Power Required (VA)	Recommended Min. TX size
RC2-1-S-027A-31C	45	75	RC2-1-S-240A-35C	123	150
RC2-1-S-040A-31C	45	75	RC2-1-S-302A-35C	123	150
RC2-1-S-052A-31C	45	75	RC2-1-S-361A-35C	201	250
RC2-1-S-065A-32C	45	75	RC2-1-S-414A-35C	150	200
RC2-1-S-077A-32C	45	75	RC2-1-S-477A-35C	225	350
RC2-1-S-096A-33C	45	75	RC2-1-S-590A-35C	225	350
RC2-1-S-124A-33C	45	75	RC2-1-S-720A-36C	225	350
RC2-1-S-125A-34C	123	150	RC2-1-S-840A-19C	225	350
RC2-1-S-156A-34C	123	150	RC2-1-S-960A-20C	225	350
RC2-1-S-180A-34C	123	150	RC2-1-S-1200A-37C	285	350

2 - TECHNICAL SPECIFICATIONS

Mechanical Drawings

2.4 Dimensions

2.4.1 RB2 Chassis with Integral Bypass

Figure 3: RB2 - 27A - 96A

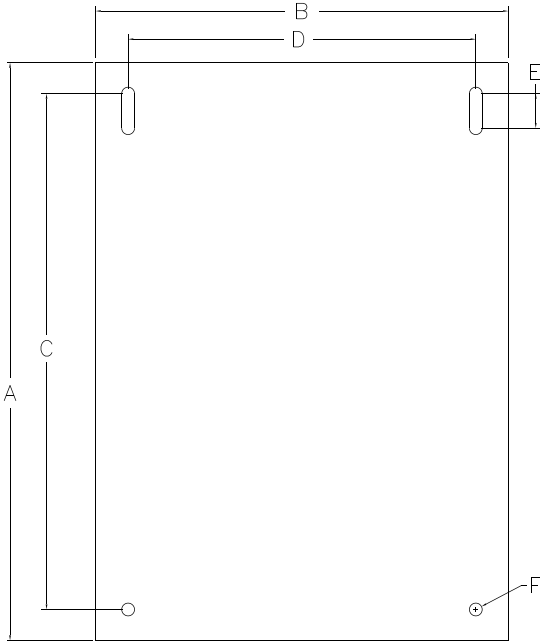

Model	A	B	C	D	E	F
RB2 27-65A	14	10	12.5	8.43	0.84	0.31
RB2 77-96A	15	10	13.5	8.43	0.84	0.31

Figure 4: RB2 125 - 361A

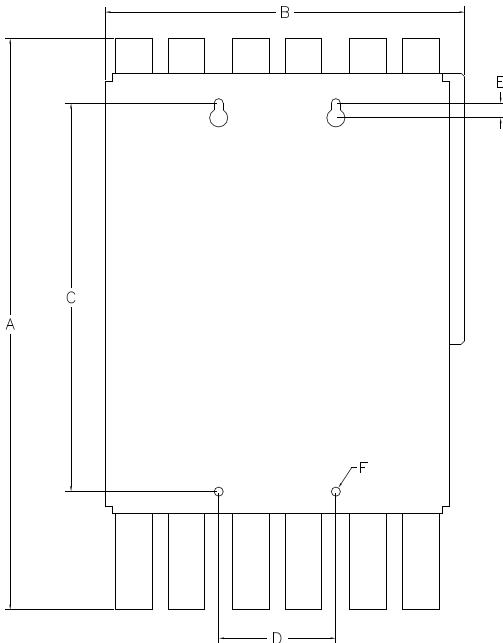

Model	A	B	C	D	E	F
RB2 125A	19.5	12.27	13.25	4	0.5	0.31
RB2 156-180A	21.25	12.00	15.25	4	0.5	0.31
RB2 180-302A	22.75	12.16	16.75	4	0.5	0.31
RB2 361A	23.91	13.16	18.63	4.31	0.5	0.31

2 - TECHNICAL SPECIFICATIONS

Figure 5: RB2 414 - 838A

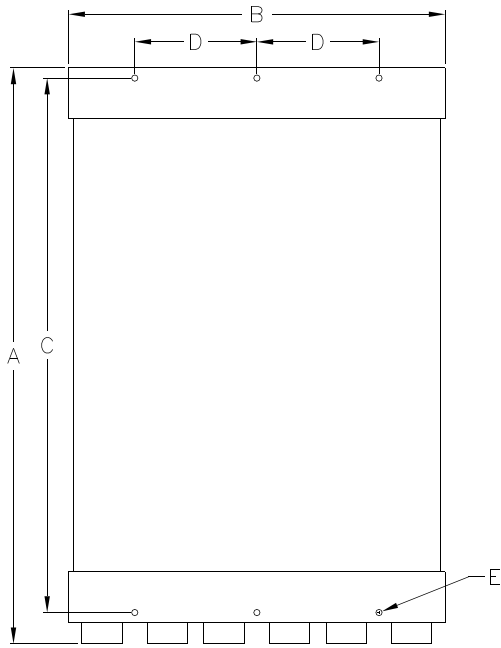

Model	A	B	C	D	E
RB2 414-590A	27.66	18.5	26.25	6	0.31
RB2 720A	29.38	18.5	28	6	0.31
RB2 838A	27.75	26.6	23.5	8.7	0.31

2 - TECHNICAL SPECIFICATIONS

2.4.2 RC2 Chassis with no Bypass

Figure 6: RC2 0 - 124A

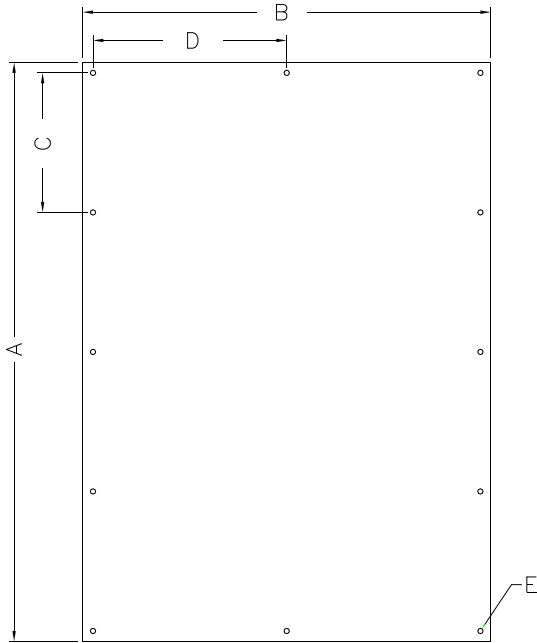

Model	A	B	C	D	E
RC2 27-52A	14	9.875	3.375	4.69	8-32 TAP
RC2 65-77A	18	10	4.375	4.75	¼-20 TAP
RC2 96-124A	27	10	5.313	4.75	¼-20 TAP

Figure 7: RC2 156 - 590A

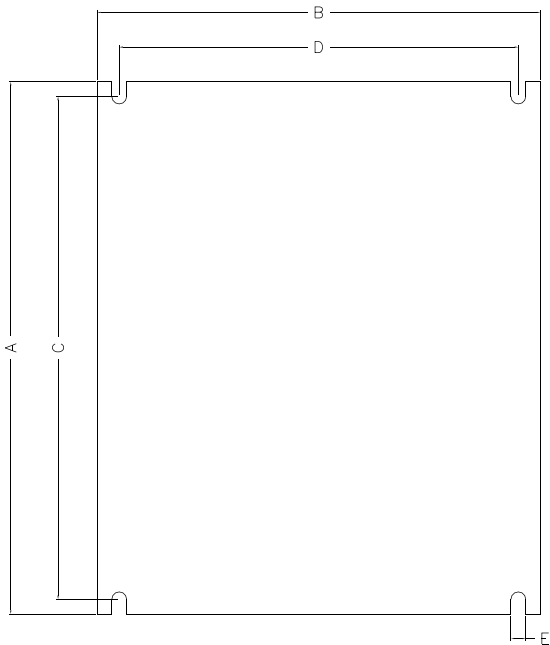

Model	A	B	C	D	E
RC2 156-180A	18	15	17	13.5	0.3
RC2 240A	24	15	23	13.5	0.5
RC2 302-361A	28	17.25	27	15.75	0.5
RC2 477A	28	20	27	18.5	0.5
RC2 590A	35	20	34	18.5	0.5

2 - TECHNICAL SPECIFICATIONS

Environmental Conditions

2.5 Environmental Conditions

Table 10: Environmental Ratings

Operating Temperatures	-10°C to +40°C (14°F to 104°F)enclosed -10°C to +50°C (14°F to 122°F)open
Storage Temperatures	-20°C to +70°C (-4°F to 155°F)
Humidity	0% to 95% non condensing
Altitude	1000m (3300ft) without derating
Maximum Vibration	5.9m/s ² (19.2ft/s ²) [0.6G]
Cooling	RC (Natural convection) RB (Bypassed)

⚠ **NOTE:** It is recommended that the starter be powered up once per year, for one hour continuously to avoid deterioration of electrolytic capacitors and subsequent starter failure.

Altitude Derating

2.6 Altitude Derating

Benshaw's starters are capable of operating at altitudes up to 3,300 feet (1000 meters) without requiring altitude derating. Table 11 provides the derating percentage to be considered when using a starter above 3,300 feet (1000 meters).

Table 11: Altitude Derating

Altitude		Percent Derating (Amps)
3300 Feet	1006 meters	0.0%
4300 Feet	1311 meters	3.0%
5300 Feet	1615 meters	6.0%
6300 Feet	1920 meters	9.0%
7300 Feet	2225 meters	12.0%
8300 Feet	2530 meters	15.0%
9300 Feet	2835 meters	18.0%

For derating above 10,000 feet consult Benshaw Inc.

2 - TECHNICAL SPECIFICATIONS

Approvals

- 2.7 Approvals**
MX² Control Card is UL, cUL Recognized

Certificate of Compliance

- 2.8 Certificate of Compliance**
CE Mark, See Appendix D on page 198.

3

Installation

3 - INSTALLATION

Before You Start

3.1 Before You Start

3.1.1 Inspection

Before storing or installing the RediStart MX² Series Starter, thoroughly inspect the device for possible shipping damage. Upon receipt:

- Remove the starter from its package and inspect exterior for shipping damage. If damage is apparent, notify the shipping agent and your sales representative.
- Open the enclosure and inspect the starter for any apparent damage or foreign objects. Ensure that all of the mounting hardware and terminal connection hardware is properly seated, securely fastened, and undamaged.
- Ensure all connections and wires are secured.
- Read the technical data label affixed to the starter and ensure that the correct horsepower and input voltage for the application has been purchased.
- The numbering system for a chassis is shown below.

3.1.2 Installation Precautions

Installation of some models may require halting production during installation. If applicable, ensure that the starter is installed when production can be halted long enough to accommodate the installation. Before installing the starter, ensure:

- The wiring diagram (supplied separately with the starter) is correct for the required application.
- The starter is the correct current rating and voltage rating for the motor being started.
- All of the installation safety precautions are followed.
- The correct power source is available.
- The starter control method has been selected.
- The connection cables have been obtained (lugs and associated mounting hardware).
- The necessary installation tools and supplies are procured.
- The installation site meets all environmental specifications for the starter NEMA/CEMA rating.
- The motor being started has been installed and is ready to be started.
- Any power factor correction capacitors (PFCC) are installed on the power source side of the starter and not on the motor side.



Failure to remove power factor correction or surge capacitors from the load side of the starter will result in serious damage to the starter that will not be covered by the starter warranty. The capacitors must be connected to the line side of the starter. The up-to-speed (UTS) contact can be used to energize the capacitors after the motor has reached full speed.

3.1.3 Safety Precautions

To ensure the safety of the individuals installing the starter, and the safe operation of the starter, observe the following guidelines:

- Ensure that the installation site meets all of the required environmental conditions (Refer to Site Preparation, page 29).
- LOCK OUT ALL SOURCES OF POWER.
- Install circuit disconnecting devices (i.e., circuit breaker, fused disconnect or non-fused disconnect) if they were not previously installed by the factory as part of the package.
- Install short circuit protection (i.e., circuit breaker or fuses) if not previously installed by the factory as part of the package.
- Consult Power Ratings for the fault rating on pages 18-20.
- Follow all NEC (National Electrical Code) and/or C.S.A. (Canadian Standards Association) standards or Local Codes as applicable.
- Remove any foreign objects from the interior of the enclosure, especially wire strands that may be left over from installation wiring.
- Ensure that a qualified electrician installs wiring.
- Ensure that the individuals installing the starter are wearing ALL protective eyewear and clothing.
- Ensure the starter is protected from debris, metal shavings and any other foreign objects.



The opening of the branch circuit protective device may be an indication that a fault current has been interrupted. To reduce the risk of electrical shock, current carrying parts and other components of the starter should be inspected and replaced if damaged.

Installation Considerations

3.2 Installation Considerations

3.2.1 Site Preparation

General Information

Before the starter can be installed, the installation site must be prepared. The customer is responsible for:

- Providing the correct power source.
- Providing the correct power protection.
- Selecting the control mechanism.
- Obtaining the connection cables, lugs and all other hardware
- Ensuring the installation site meets all environmental specifications for the enclosure NEMA rating.
- Installing and connecting the motor.

Power Cables

The power cables for the starter must have the correct NEC/CSA current rating for the unit being installed. Depending upon the model, the power cables can range from a single #14 AWG conductor to four 750 MCM cables. (Consult local and national codes for selecting wire size).

Site Requirements

The installation site must adhere to the applicable starter NEMA/CEMA rating. For optimal performance, the installation site must meet the appropriate environmental and altitude requirements.

3.2.2 EMC Installation Guidelines

General	In order to help our customers comply with European electromagnetic compatibility standards, Benschaw Inc. has developed the following guidelines.
Attention	This product has been designed for Class A equipment. Use of the product in domestic environments may cause radio interference, in which case the installer may need to use additional mitigation methods.
Enclosure	Install the product in a grounded metal enclosure.
Grounding	Connect a grounding conductor to the screw or terminal provided as standard on each controller. Refer to layout/power wiring schematic for grounding provision location.
Wiring	Refer to Wiring Practices on page 31.
Filtering	To comply with Conducted Emission Limits (CE requirement), a high voltage (1000V or greater) 0.1 uF capacitor should be connected from each input line to ground at the point where the line enters the cabinet.

3.2.3 Use of Power Factor Capacitors

Power factor correction capacitors and surge capacitors CAN NOT be connected between the starter and the motor. These devices can damage the SCRs during ramping. These devices appear like a short circuit to the SCR when it turns on, which causes a di/dt level greater than the SCR can handle. If used, power factor correction capacitors or surge capacitors must be connected ahead of the starter and sequenced into the power circuit after the start is completed. A programmable relay can be configured as an up-to-speed (UTS) relay and then used to pull-in a contactor to connect the capacitors after the motor has reached full speed.

⚠ **NOTE:** If the motor manufacturer supplies surge capacitors they must be removed before starting.

3.2.4 Use of Electro-Mechanical Brakes

If an electro-mechanical brake is used with the starter, it must be powered from the line side of the starter to ensure full voltage is applied to the brake during a start so it will properly release. A programmable relay can be configured as a run relay and then used to pull-in a contactor to power the brake whenever the starter is not providing power to the motor.

3.2.5 Reversing Contactor

If the application requires a reversing contactor, it should be connected on the output side (load) of the soft starter. The contactor must be closed before starting the soft starter. The soft starter must be off before switching the direction of the reversing contactor. The reversing contactor must never be switched while the soft starter is operating.

3 - INSTALLATION

Mounting Considerations

3.3 Mounting Considerations

3.3.1 Bypassed Starters

Provisions should be made to ensure that the average temperature inside the enclosure never rises above 50°C. If the temperature inside the enclosure is too high, the starter can be damaged or the operational life can be reduced.

3.3.2 Non-Bypassed Starters

Provisions should be made to ensure that the temperature inside the enclosure never rises above 50°C. If the temperature inside the enclosure is too high, the starter can be damaged or the operational life can be reduced. As a general rule of thumb, the following ventilation guidelines can be followed.

Table 12: Ventilation Requirements

Current Range	Bottom of Enclosure	Top of Enclosure
< 200 amps	Fans or grills depending on enclosure size	
200 to 300 amps	2 x 4" grills (12 sq. in.)	2 x 4" grills (12 sq.in.)
301 to 400 amps	1 x 4" fan (115 cfm)	2 x 4" grills (12 sq.in.)
401 to 600 amps	2 x 4" fan (230 cfm)	2 x 6" grills (28 sq.in.)
601 to 700 amps	2 x 6" fan (470 cfm)	2 x 6" grills (28 sq.in.)
> 700 amps	Consult factory	Consult Factory

The starter produces 4 watts of heat per amp of current and 26 square inches of enclosure surface is required per watt of heat generation. Contact Benschaw and ask for the enclosure sizing technical note for more information concerning starters in sealed enclosures. Benschaw supplies starters under 124 amps non-bypassed, with the heat sink protruding from the back of the enclosure. This allows a small enclosure size while still maintaining the cooling capability of the starter.

Wiring Considerations

3.4 Wiring Considerations

3.4.1 Wiring Practices

When making power and control signal connections, the following should be observed:

- Never connect input AC power to the motor output terminals T1/U, T2/V, or T3/W.
- Power wiring to the motor must have the maximum possible separation from all other wiring. Do not run control wiring in the same conduit; this separation reduces the possibility of coupling electrical noise between circuits. Minimum spacing between metallic conduits containing different wire groups should be three inches (8cm).
- Minimum spacing between different wiring groups in the same tray should be six inches.
- Wire runs outside an enclosure should be run in metallic conduit or have shielding/armor with equivalent attenuation.
- Whenever power and control wiring cross it should be at a 90 degrees angle.
- Different wire groups should be run in separate conduits.
- With a reversing application, the starter must be installed in front of the reversing contactors.

⚠ **NOTE:** Local electrical codes must be adhered to for all wiring practices.

3.4.2 Considerations for Control and Power Wiring

Control wiring refers to wires connected to the control terminal strip that normally carry 24V to 115V and Power wiring refers to wires connected to the line and load terminals that normally carries 208VAC - 600VAC respectively. Select power wiring as follows:

- Use only UL or CSA recognized wire.
- Wire voltage rating must be a minimum of 300V for 230VAC systems and 600V (Class 1 wire) for 460VAC and 600VAC systems.
- Grounding must be in accordance with NEC, CEC or local codes. If multiple starters are installed near each other, each must be connected to ground. Take care to not form a ground loop. The grounds should be connected in a STAR configuration.
- Wire must be made of copper and rated 60/75°C for units 124 Amps and below. Larger amp units may use copper or aluminum wire. Refer to NEC table 310-16 or local codes for proper wire selection.

3.4.3 Considerations for Signal Wiring

Signal wiring refers to the wires connected to the control terminal strip that are low voltage signals, below 15V.

- Shielded wire is recommended to prevent electrical noise interference from causing improper operation or nuisance tripping.
- Signal wire rating should carry as high of a voltage rating as possible, normally at least 300V.
- Routing of signal wire is important to keep as far away from control and power wiring as possible.

3.4.4 Meggering a Motor

If the motor needs to be meggered, remove the motor leads from the starter before conducting the test. Failure to comply may damage the SCRs and WILL damage the control board, which WILL NOT be replaced under warranty.

3.4.5 High Pot Testing

Perform a DC high pot test if it is necessary to verify the insulation of the soft starter. The factory test voltage used is two and a half times the RMS voltage plus 1000VDC. It is recommended to test equipment that has been in service to 75% of the factory test voltage. The SCR gate leads must be removed from the control board to perform the high pot test. Remove the twisted red and white wire pairs labeled from 1 to 6 that connect on the right side of the control card. Failure to comply with the test voltage or removing the gate wiring may damage the control board which will not be replaced under warranty..

3 - INSTALLATION

Power and Control Drawings for Bypassed and Non Bypassed Power Stacks

3.5 Power and Control drawings for Bypassed and Non Bypassed Power Stacks

Figure 8: Power Schematic for RB2 Low HP

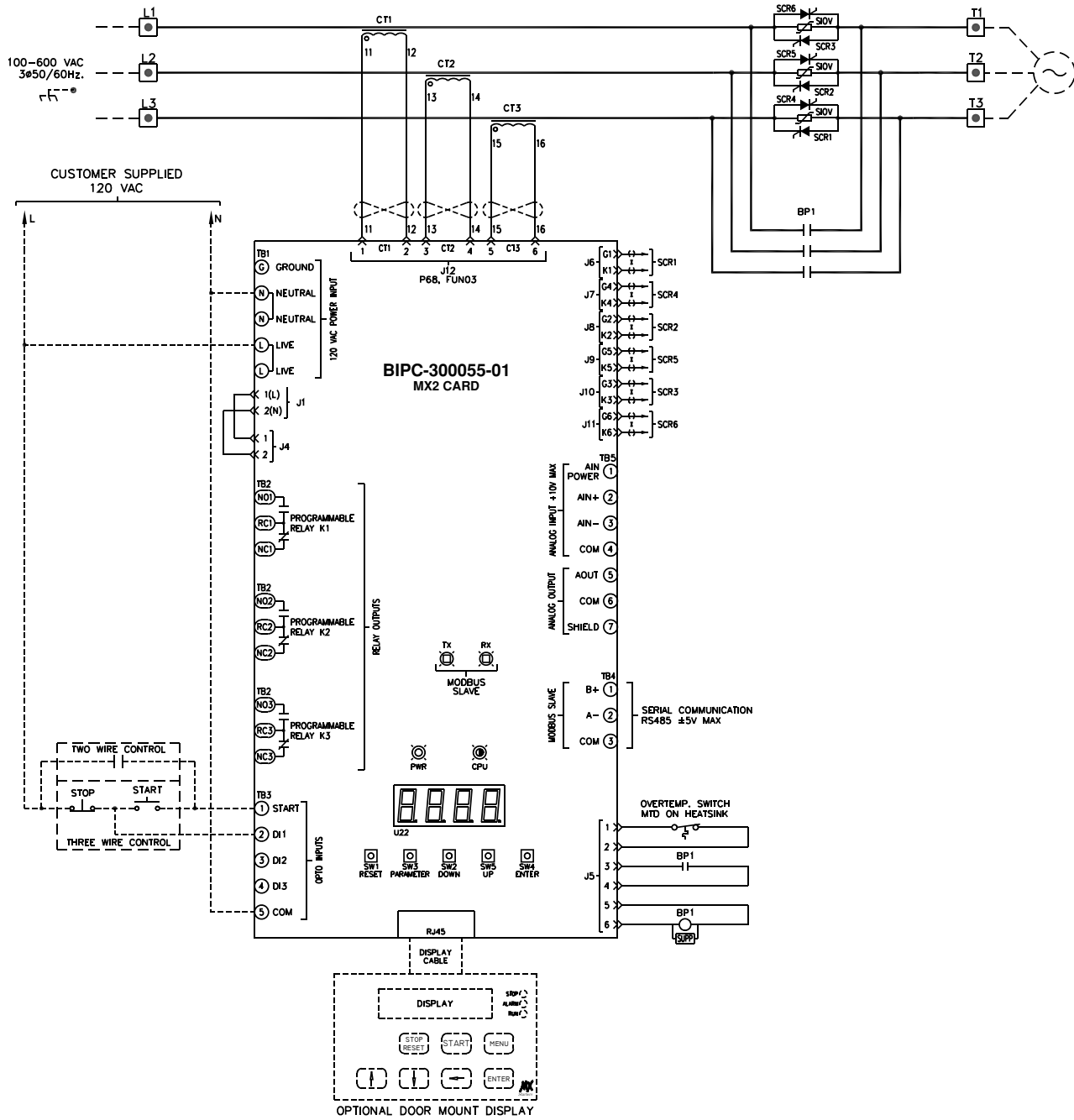
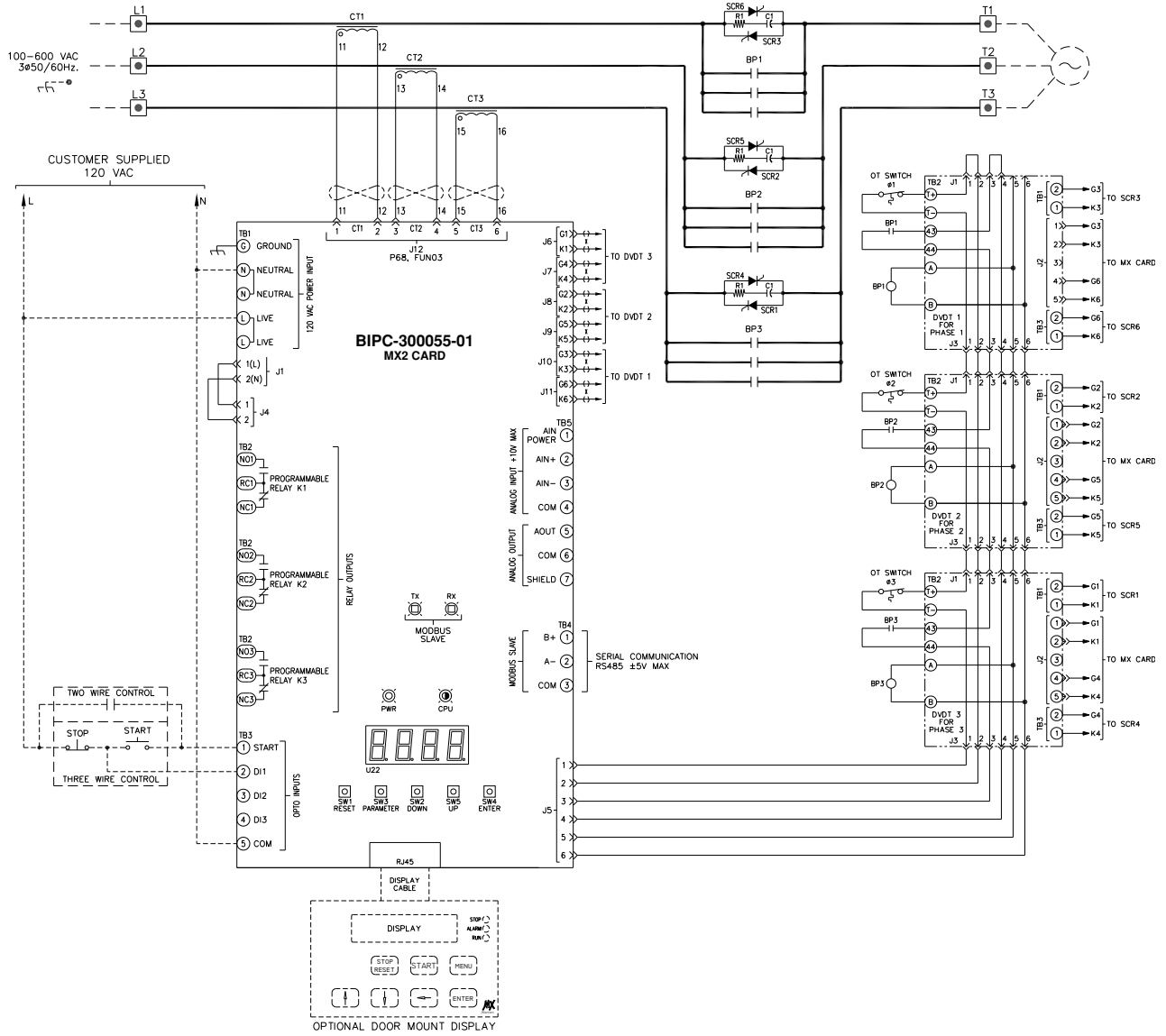
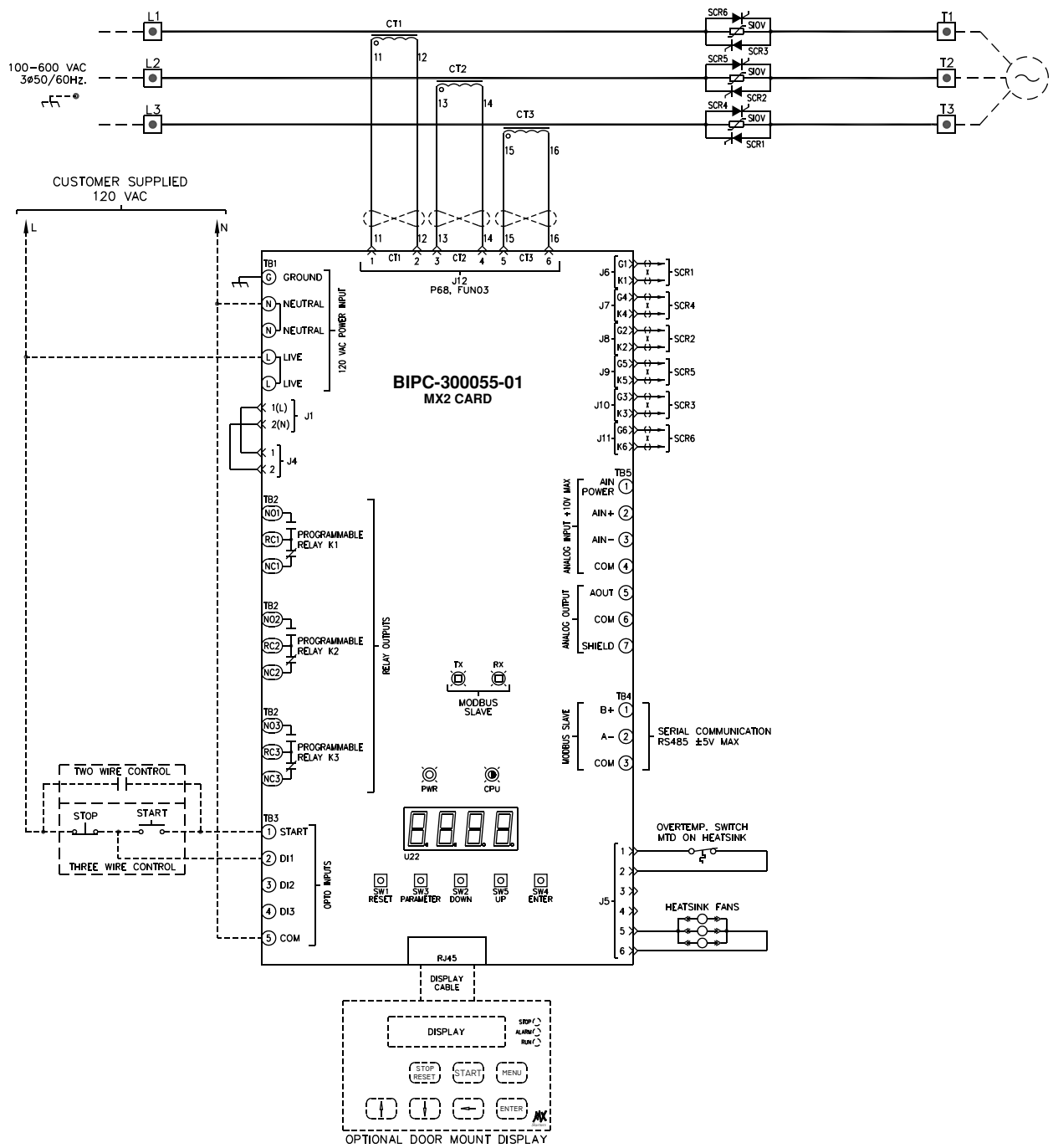

Figure 9: Power Schematic for RB2 High HP



3 - INSTALLATION

Figure 10: Power Schematic for RC2



3.6 Power Wiring

3.6.1 Recommended Incoming Line Protection

Fuses or Circuit Breaker, refer to pages 18 - 20.

Input Line Requirements

The input line source needs to be an adequate source to start the motor, generally 2 times the rating of the motor FLA. (This may not apply in some cases such as being connected to a generator).

3.6.2 Recommended Wire Gauges

The wire gauge selection is based on the FLA of the motor. Refer to NEC table 310-16 or CEC Part 1, Table 2 or local code requirements for selecting the correct wire sizing. Ensure appropriate wire derating for temperature is applied. If more than three current carrying conductors are in one conduit, ensure NEC table 310.15(B)(2) or CEC Part 1 Table 5C is adhered to. In some areas local codes may take precedence over the NEC. Refer to your local requirements.

3.6.3 Power Wire Connections

Attach the motor cables:

- Use the T1, T2 and T3 terminals. Use lugs/crimps or terminals (Lugs and Crimps are to be provided by the user).

Attach the power source cables:

- Use the L1, L2 and L3 terminals. Use lugs/crimps or terminals (Lugs and Crimps are to be provided by the user).

3.6.4 Motor Lead Length

The standard starter can operate a motor with a maximum of 2000 feet of properly sized cable between the “T” leads of the starter and that of the motor. For wire runs greater than 2000 feet contact Benschaw Inc. for application assistance. If shielded cable is used, consult factory for recommended length.

3 - INSTALLATION

3.6.5 Compression Lugs

The following is a list of the recommended crimp-on wire connectors manufactured by Penn-Union Corp. for copper wire.

Table 13: Single Hole Compression Lugs

Wire Size	Part #	Wire Size	Part #
1/0	BLU-1/0S20	500 MCM	BLU-050S2
2/0	BLU-2/0S4	600 MCM	BLU-060S1
3/0	BLU-3/0S1	650 MCM	BLU-065S5
4/0	BLU-4/0S1	750 MCM	BLU-075S
250 MCM	BLU-025S	800 MCM	BLU-080S
300 MCM	BLU-030S	1000 MCM	BLU-100S
350 MCM	BLU-035S	1500 MCM	BLU-150S
400 MCM	BLU-040S4	2000 MCM	BLU-200s
450 MCM	BLU-045S1		

Table 14: Two Hole Compression Lugs

Wire Size	Part #	Wire Size	Part #
1/0	BLU-1/0D20	500 MCM	BLU-050D2
2/0	BLU-2/0D4	600 MCM	BLU-060D1
3/0	BLU-3/0D1	650 MCM	BLU-065D5
4/0	BLU-4/0D1	750 MCM	BLU-075D
250 MCM	BLU-025D	800 MCM	BLU-080D
300 MCM	BLU-030D	1000 MCM	BLU-100D
350 MCM	BLU-035D	1500 MCM	BLU-150D
400 MCM	BLU-040D4	2000 MCM	BLU-200D
450 MCM	BLU-045D1		

3.6.6 Torque Requirements for Power Wiring Terminations

Table 15: Slotted Screws and Hex Bolts

Wire size installed in conductor		Tightening torque, pound-inches (N-m)							
		Slotted head NO. 10 and larger				Hexagonal head-external drive socket wrench			
AWG or kcmil	(mm ²)	Slot width-0.047 inch (1.2mm) or less and slot length ¼ inch (6.4mm) or less		Slot width-over 0.047 inch (1.2mm) or slot length – over ¼ inch (6.4mm) or less		Split- bolt connectors (N-m)		Other connectors (N-m)	
18 – 10	(0.82 – 5.3)	20	(2.3)	35	(4.0)	80	(9.0)	75	(8.5)
8	(8.4)	25	(2.8)	40	(4.5)	80	(9.0)	75	(8.5)
6 – 4	(13.3 – 21.2)	35	(4.0)	45	(5.1)	165	(18.6)	110	(12.4)
3	(26.7)	35	(4.0)	50	(5.6)	275	(31.1)	150	(16.9)
2	(33.6)	40	(4.5)	50	(5.6)	275	(31.1)	150	(16.9)
1	(42.4)	—	—	50	(5.6)	275	(31.1)	150	(16.9)
1/0 – 2/0	(53.5 – 64.4)	—	—	50	(5.6)	385	(43.5)	180	(20.3)
3/0 – 4/0	(85.0 – 107.2)	—	—	50	(5.6)	500	(56.5)	250	(28.2)
250 – 350	(127 – 177)	—	—	50	(5.6)	650	(73.4)	325	(36.7)
400	(203)	—	—	50	(5.6)	825	(93.2)	375	(36.7)
500	(253)	—	—	50	(5.6)	825	(93.2)	375	(42.4)
600 – 750	(304 – 380)	—	—	50	(5.6)	1000	(113.0)	375	(42.4)
800 – 1000	(406 – 508)	—	—	50	(5.6)	1100	(124.3)	500	(56.5)
1250 – 2000	(635 – 1010)	—	—	—	—	1100	(124.3)	600	(67.8)

⚠ NOTE – For a value of slot width or length not corresponding to those specified above, the largest torque value associated with the conductor size shall be marked. Slot width is the nominal design value. Slot length is measured at the bottom of the slot.

3 - INSTALLATION

Table 16: Tightening Torque for Inside Hex Screws

Socket size across flats		Tightening torque	
inches	(mm)	Pound-inches	(N-m)
1/8	(3.2)	45	(5.1)
5/32	(4.0)	100	(11.3)
3/16	(4.8)	120	(13.6)
7/32	(5.6)	150	(16.9)
1/4	(6.4)	200	(22.6)
5/16	(7.9)	275	(31.1)
3/8	(9.5)	275	(42.4)
1/2	(12.7)	500	(56.5)
9/16	(14.3)	600	(67.8)

⚠ **NOTE** – For screws with multiple tightening means, the largest torque value associated with the conductor size shall be marked. Slot length shall be measured at the bottom of the slot.

Current Transformers

3.7 Current Transformers

3.7.1 CT Mounting

For starters larger than 124 amps, the CTs are shipped loose from the power stack and need to be mounted on the power wiring. Thread the incoming lead through the CT with the polarity mark towards the line side. (The polarity marks may be a white or yellow dot, an “X” on the side of the CT, or the white wire.) Each phase has its own CT. The CT must then be attached to the power wiring, at least three inches from the power wire lugs, using two tie-wraps.

Figure 11: Typical CT Mounting, Input of Starter

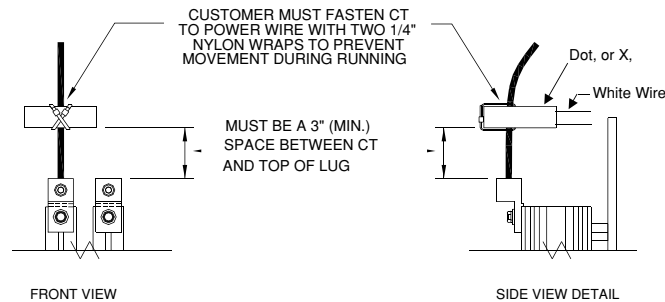

3.7.2 CT Polarity

The CT has a polarity that must be correct for the starter to correctly measure Watts, kW Hours, Power Factor, and for the Power and TruTorque motor control functions to operate properly.

Each CT has a dot on one side of the flat surfaces. This dot, normally white in color, must be facing in the direction of the line.

CT1 must be on Line L1, CT2 must be on Line L2, CT3 must be on Line L3.

Control Card Layout

3.8 Control Card Layout

Figure 12: Control Card Layout

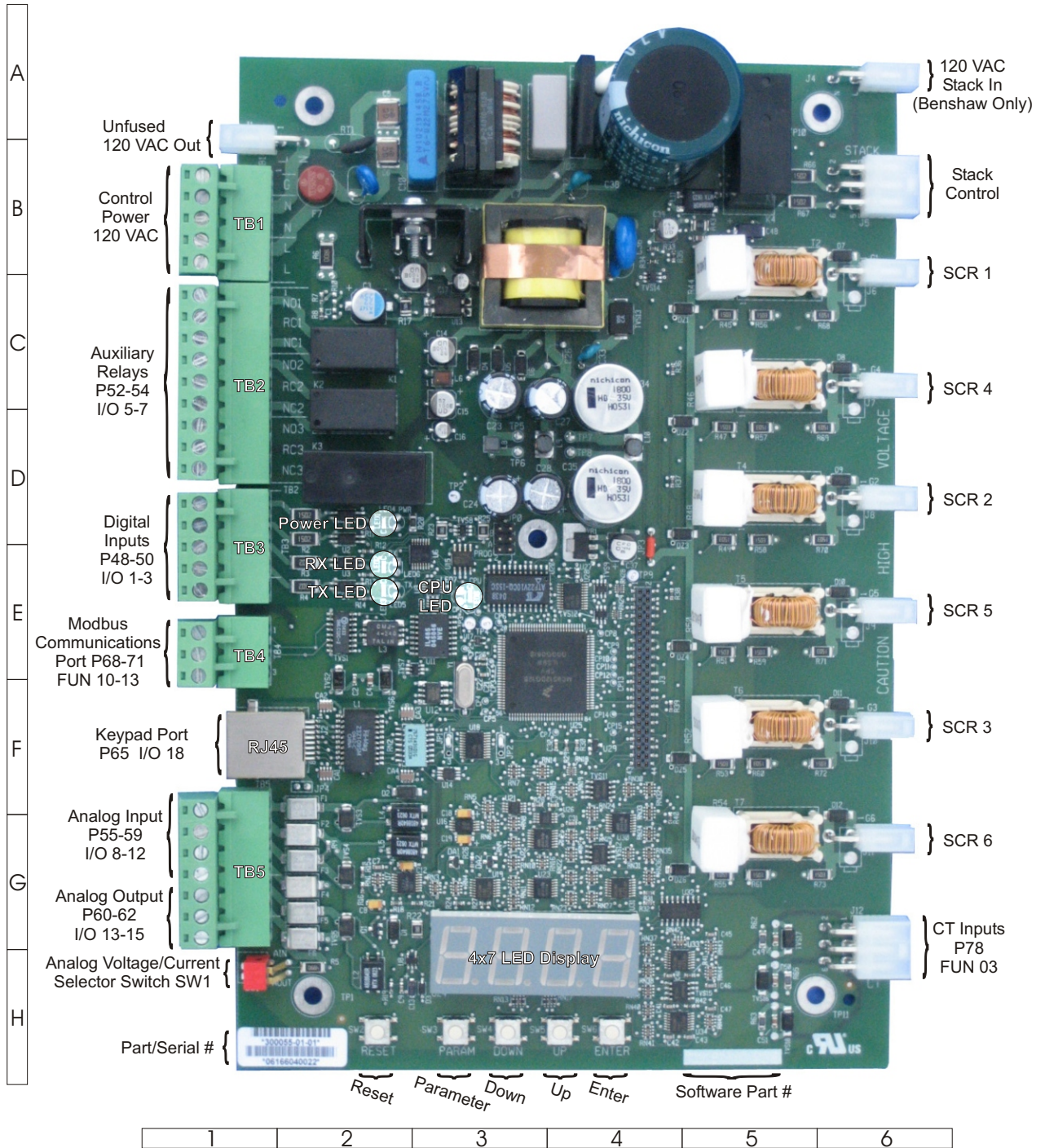

3 - INSTALLATION

Control Wiring

3.9 Control Wiring

3.9.1 Control Power

The 120VAC control power is supplied to TB1. The connections are as follows:

- 1 - Ground
- 2 - Neutral
- 3 - Neutral
- 4 - Line (120VAC)
- 5 - Line (120VAC)

Figure 13: Control Power Wiring Example

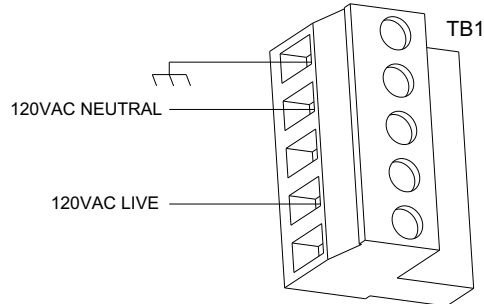

3.9.2 Output Relays

TB2 is for the output relays. The relays connect as follows:

- 1 - NO1: Relay 1 normally open
- 2 - RC1: Relay 1 common
- 3 - NC1: Relay 1 normally closed
- 4 - NO2: Relay 2 normally open
- 5 - RC2: Relay 2 common
- 6 - NC2: Relay 2 normally closed
- 7 - NO3: Relay 3 normally open
- 8 - RC3: Relay 3 common
- 9 - NC3: Relay 3 normally closed

Figure 14: Relay Wiring Examples

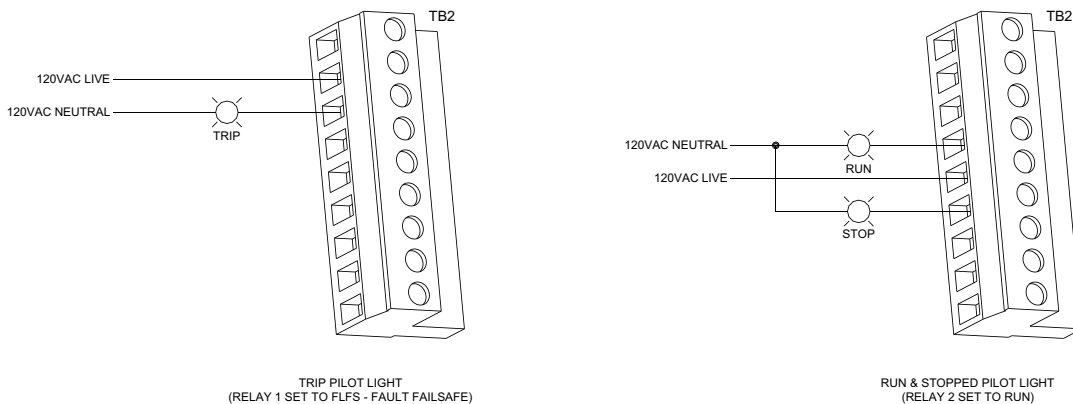

See Also Relay Output configuration (I/O 05 - 07) on page 112.

3 - INSTALLATION

3.9.3 Digital Input Wiring Options

TB3 is for the digital inputs. The digital inputs use 120VAC. The digital inputs are as follows:

- 1 - Start: Start Input
- 2 - DI1: Digital Input 1
- 3 - DI2: Digital Input 2
- 4 - DI3: Digital Input 3
- 5 - Com: 120VAC neutral

Figure 15: Digital Input Wiring Examples

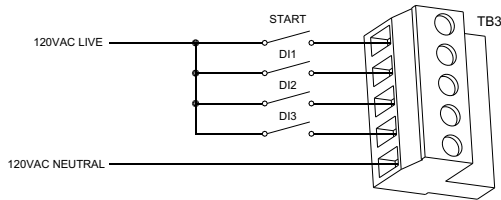

DIGITAL INPUT WIRING

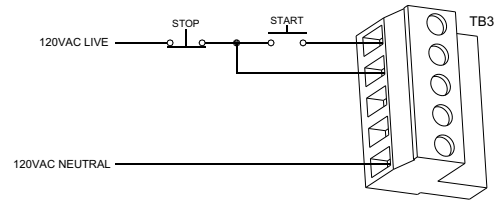

**3-WIRE START / STOP BUTTONS
(DI1 SET TO STOP)**

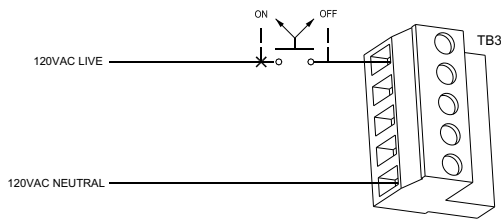

2-WIRE ON / OFF SELECTOR SWITCH

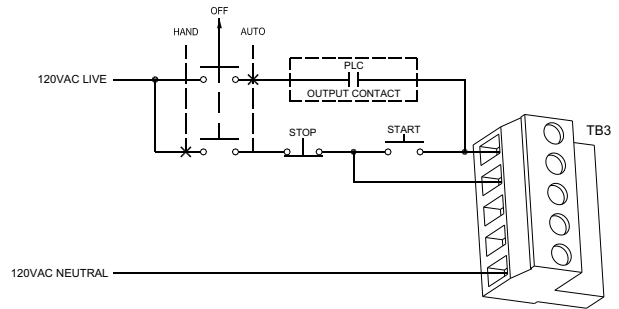

**HAND / OFF / AUTO SELECTOR SWITCH
(DI1 SET TO STOP)**

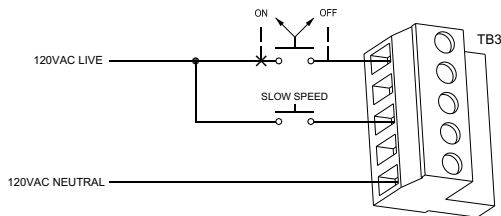

**SLOW SPEED CONTROL BUTTON
(DI2 SET TO SSPD - SLOW SPEED)**

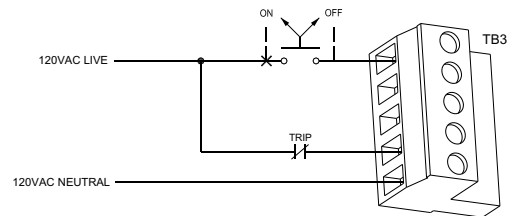

**EXTERNAL TRIP INPUT
(DI3 SET TO FL - FAULT LOW)**

See Also Digital Input configuration (I/O 01 - 03) on page 110.

3 - INSTALLATION

3.9.4 Analog Input

The analog input can be configured for voltage or current loop. The input is shipped in the voltage loop configuration unless specified in a custom configuration. Below TB5 is SW1-1. When the switch is in the on position, the input is current loop. When off, it is a voltage input. The control is shipped with the switch in the off position. See Figure 18.

⚠ **NOTE:** The analog input is a low voltage input, maximum of 15VDC. The input will be damaged if control power (115VAC) or line power is applied to the analog input.

The terminals are as follows:

- 1) +10VDC Power (for POT)
- 2) + input
- 3) - input
- 4) common
- 7) shield

Figure 16: Analog Input Wiring Examples

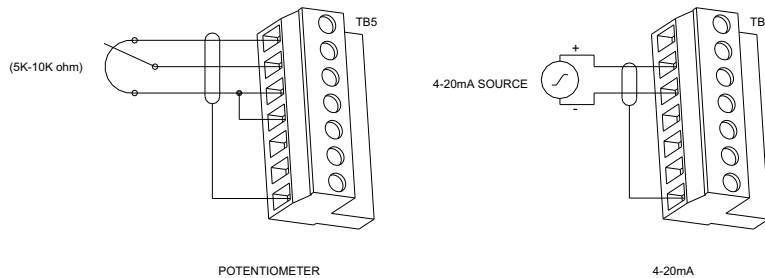

See Also Analog Input (I/O 08 - 12) on page 113.
Starter Type parameter (FUN 07) on page 124.
Theory of Operation section 7.11, Phase Control on page 165.
Theory of Operation section 7.12, Current Follower on page 167.

3.9.5 Analog Output

The analog output can be configured for Voltage or Current loop. The output is shipped in the Voltage loop configuration unless specified in a custom configuration. Below TB5 is SW1-2. When the switch is in the off position, the output is current. When on, it is a Voltage loop output. The control is shipped with the Switch on. See Figure 18.

⚠ **NOTE:** The analog output is a low voltage output, maximum of 15VDC. The output will be damaged if control power (115VAC) or line power is applied to it.

The terminals are as follows:

- 5 - analog output
- 6 - common
- 7 - shield

Figure 17: Analog Output Wiring Example

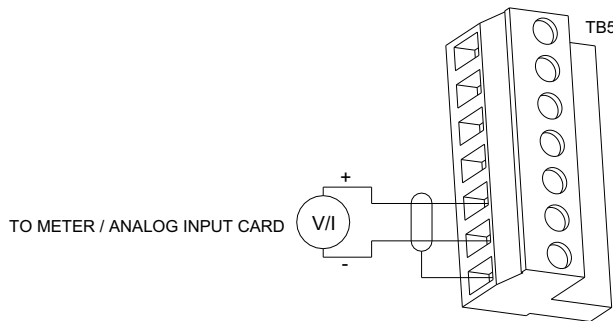

See Also Analog Output configuration (I/O 13 - 15) on page 116.

3.9.6 SW1 DIP Switch

The DIP switch on the card changes the analog input and analog output between 0-10V or 0-20mA. The picture below shows how to adjust the switch to select the desired signal. Switching to the up or top position is ON and switching towards card or down is OFF.

Figure 18: DIP Switch Settings

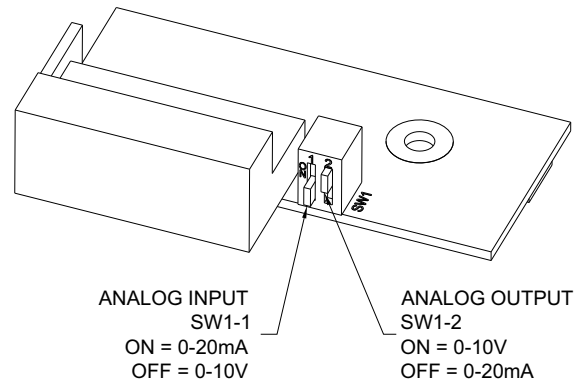

Remote LCD Keypad/Display

3.10 Remote LCD Keypad/Display

The display has a NEMA 13/IP65 service rating. The display is available in 2 versions, a small display as P/N KPMX3SLCD and large display as P/N KPMX3LLCD.

3.10.1 Remote Display

The MX² control has one of two types of keypads, either a LED display or a LCD display. As standard, a LED display is permanently mounted on the control board. The LCD keypad is optional and is mounted remotely from the MX² Control card via a straight through CAT5 ethernet cable which connects between the MX² RJ45 terminal and remote display's RJ45 terminal.

3 - INSTALLATION

3.10.2 Display Cutout

Figure 19: Small Display Keypad Mounting Dimensions
Part # : KPMX3SLCD

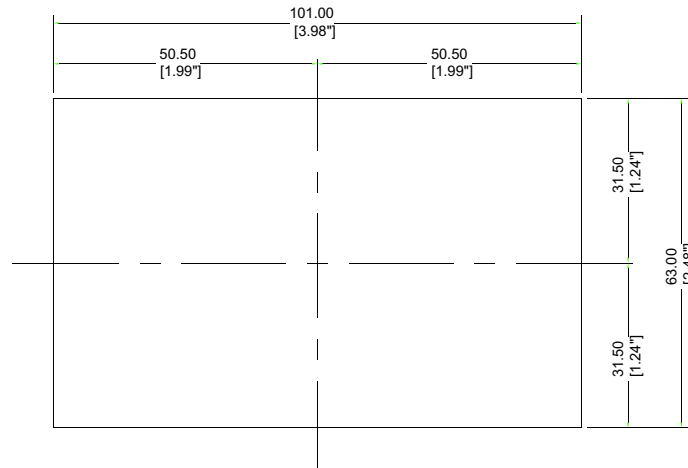
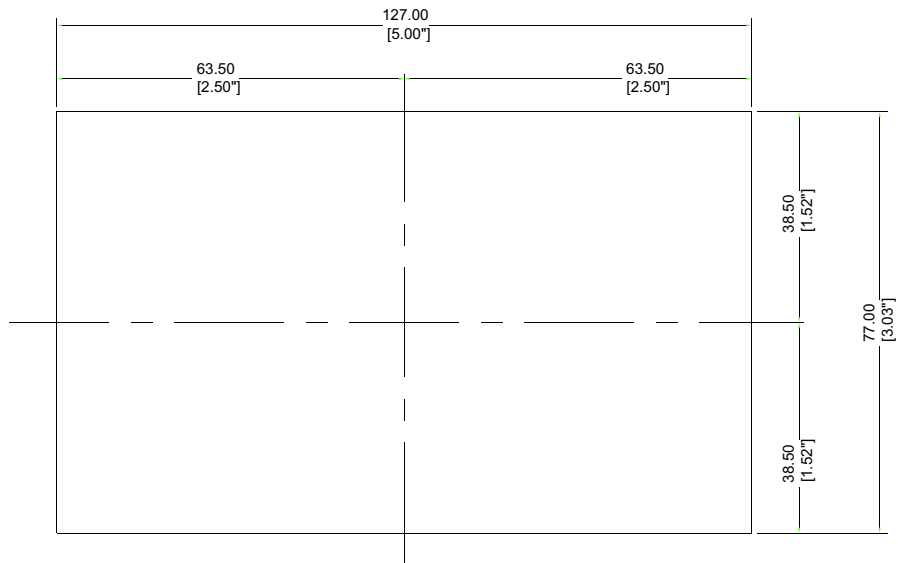

Figure 20: Large Display Keypad Mounting Dimensions
Part # : KPMX3LLCD



3.10.3 Installing Display

The remote display is installed as follows:

- Install the gasket onto the display.
- Insert the display through the door cutout.
- Insert the mounting clips into the holes in each side of the display.
- Tighten the mounting clips until they hold the display securely in place. Torque requirements for the display screen is 0.7 NM (6.195 in lbs).
- Plug the cable into the display connector on the MX² card. See Figure 12 – Control Card Layout on page 39 for the connector location.
- Route the cable through the enclosure to the display. Observe the wiring considerations as listed in section 3.4.3 on page 31.
- Plug the other end of the cable into the LCD display.

⚠ **NOTE:** At temperatures less than -20 C, the LCD contrast may be impaired.

Figure 21: Mounting Remote Keypads

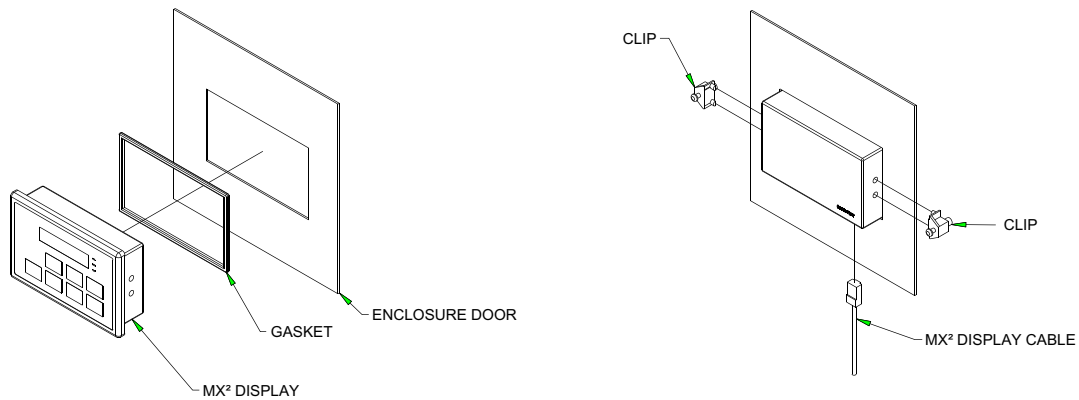

3 - INSTALLATION

NOTES:

4 Keypad Operation

4 - KEYPAD OPERATION

Introduction

4.1 Introduction

The MX² provides a comprehensive set of parameters to allow the use of the reduced voltage solid state starter in nearly any industrial application. While the starter can meet the requirements of many applications right out of the box, customization of parameter values to better suit your particular application is easily accomplished with the standard, on-board, 4-digit, 7-segment LED display/keypad.

The MX² has an optional 2x16 character, back-lit LCD display/keypad that may be mounted remotely from the MX² control card. The remote LCD keypad has the same keys as the standard display with several additional keys including start and stop keys for operation of the starter from the keypad. When the remote LCD keypad is connected, the local display is disabled.

Standard Keypad and Display

4.2 Standard Keypad and Display

The LED display provides information on starter operation and programming. The 4-digit, 7-segment display shows starter meter outputs and programming data. Special symbols provide further information about the starter operation (see the following section).

Figure 22: The Standard Keypad and Display

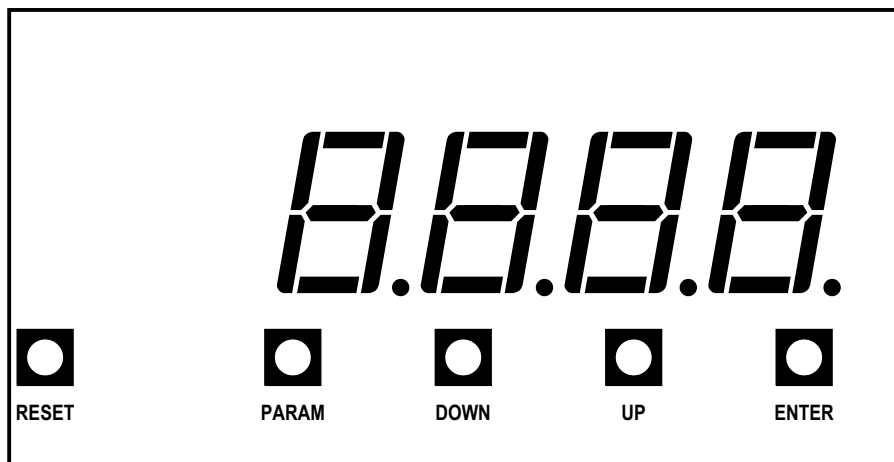

Viewing Parameter Values for the Standard Keypad

4.3 Viewing Parameter Values for the Standard Keypad

Parameter view mode can be entered by:

1. At the default meter display, press the [PARAM] key to enter parameter mode. "P1" is displayed to indicate Parameter 1.
2. Use the [UP] and [DOWN] keys to scroll through the available parameters.
3. Pressing the [UP] key from "P 1" advances to parameter "P 2".
4. Pressing the [DOWN] key from "P1" wraps around to the highest parameter.
5. The value of the parameter can be viewed by pressing the [ENTER] key.
6. To view another parameter without changing/saving the parameter, press the [PARAM] key to return to the parameter number display.

To return to the default meter display either:

1. Press the [PARAM] key while in the parameter number display mode.
2. Wait 60 seconds and the display returns to the default meter display.

Changing Parameter Values

4.4 Changing Parameter Values

Parameter change mode can be entered by:

1. At the default meter display, press the [PARAM] key to enter parameter mode.
2. Use the [UP] and [DOWN] keys to scroll through the available parameters.
3. The value of the parameter can be viewed by pressing the [ENTER] key.
4. When viewing the parameter value, the parameter can be changed by using the [UP] and [DOWN] keys.
5. To store the new value, press the [ENTER] key. When the [ENTER] key is pressed the value is saved and the display goes back to parameter # "P_".

To exit parameter change mode without saving the new parameter value either:

1. Press the [PARAM] key to return to the parameter number display.
2. Wait 60 seconds and the display returns to the default meter display.

Messages Displayed

4.5 Messages Displayed

In addition to being able to view and change parameters, various special messages may be displayed during different conditions. Here is a summary of the possible special messages.

noL	No Line	AbC	Phase order meter showing ABC
rdY	Ready	CbA	Phase order meter showing CBA
Acc	Accelerating or Kicking	SPH	Phase order meter showing Single Phase
Acc2	Accelerating or Kicking with ramp 2	oxxx	xxx = overload content.
utS	Up to Speed	P xx	xx = Parameter code.
run	Run - Done with Accel ramp but not yet Up to Speed	A xx	xx = Alarm code. If the condition persists, a fault occurs.
dcl	Decelerating Motor	F xx	xx = Fault code.
A OL	Overload Alarm - The motor overload level is between 90% and 100%	ioc	Instantaneous Over current
F OL	Overload Fault - The motor overload level has reached 100%	dFLt	Default – Flashes when parameter defaults are loaded.
		HEAt	Heater/Anti-windmill Mode
L OL	Overload Lockout - A start is not allowed until the motor overload level cools below 15%.	ES	Energy Saver
		FLSH	In reflash mode
L CP	Control Power Lockout - A start is not allowed because the control power is too low.	PrOG	In reflash mode, programming
		rEAd	In reflash mode, verifying
LOC	Lock out State	donE	In reflash mode, complete
SSPd	Slow Speed Motor Operation	L dS	Disconnect Switch Open
L Ot	Power Stack Over Temperature Lockout	dcb	DC Injection Brake Active
SS r	Slow Speed Reverse	SS F	Slow Speed Forward
L I r	Digital Inputs (Run Enable or Run Disable) are preventing the starter from running		

The following sections provide more detail for some of the conditions that cause special messages to be displayed.

4.5.1 Power Up

The software version is displayed as a series of single digits once power has been applied to the MX². If the parameters were being reset on power up, “dFLt” is flashed on the display for three seconds, and then the software version is displayed.

4.5.2 Stopped

When the starter is not in the run mode, the display shows the status condition of the starter, such as “rdY” (ready), “L OL” (Overload Lockout), or “noL” (No Line).

4 - KEYPAD OPERATION

4.5.3 Running

When running, the display shows the selected meter function. The following meters can be selected using the Meter display parameter (P79).

Avg. RMS current	Avg. Voltage (RMS)	KW	Line Frequency	TruTorque %
Phase 1 RMS current	L1-L2 Voltage (RMS)	KVA	Analog Input %	Power %
Phase 2 RMS current	L2-L3 Voltage (RMS)	VARS	Analog Output %	Last Start Time
Phase 3 RMS current	L3-L1 Voltage (RMS)	KWh	Running Time Days	Peak Start Current
Current Imbalance %	Overload %	MWh	Running Time Hours	
GF Current (% FLA)	Power Factor	Phase Rotation	Starts	

4.5.4 Alarm Condition

When an alarm condition exists, the display alternates between displaying the selected meter and the alarm code. The alarm code is displayed as “A XX”, where XX is the alarm code.

- When a thermal overload alarm condition exists, “A OL” is displayed.
- When a no line alarm condition exists, “noL” is displayed.

When the starter is stopped, the selected meter is not displayed.

4.5.5 Lockout Condition

When a lockout condition exists, the display shows the lockout code. The lockout code is displayed as “L XX”: where XX is the lockout code. Following are the defined lockout conditions and their codes:

- When a motor thermal overload lockout condition exists, “L OL” is displayed.
- When a power stack thermal overload lockout condition exists, “L Ot” is displayed.
- When a low control power lockout condition exists, “L CP” is displayed.
- When either Run Enable or Run Disable input are preventing the starter from running.

When there are multiple lockout codes, each is displayed at 2 second intervals.

4.5.6 Faulted Condition

When a fault condition exists, the display shows the fault code. The exceptions to this are as follows:

- When the fault is thermal overload trip, “F OL” is displayed.
- When the fault is Instantaneous Over current, “ioc” is displayed.

4.5.7 Quick Meters

Although any meter may be viewed by changing the Meter parameter (P79), there are 3 “Quick Meters” that are always available with a single key press. When the starter is in the normal display mode, the display may be toggled between the information currently displayed and the following quick meters.

Status Meter	Toggle between the programmed meter display and the starter operational status display (rdY, run, utS, dcL, etc) by pressing the [ENTER] key.
Overload Meter	Toggle between the programmed meter display and the overload content by pressing the [DOWN] key. The overload is displayed as “oXXX” where XXX is the overload content. For example, when the overload content is 76 percent, it is displayed as “o 76”.
Phase Order Meter	Toggle between the programmed meter display and the phase order by pressing the [UP] key. The phase order is displayed as “AbC” or “CbA”.

Restoring Factory Parameter Settings

4.6 Restoring Factory Parameter Settings

To restore ALL parameters to the factory default settings, press and hold the [PARAM] and [ENTER] pushbutton switch on power up. The display blinks “dFlt”. Parameters unique to the motor starter applications need to be set again to appropriate values before motor operation.

P76 / FUN05 - Rated RMS Voltage (set to specified equipment rating)
P78 / FUN03 - CT Ratio (set to supplied CTs rating)
P48 / I/O01 - Digital Input #1
P49 / I/O02 - Digital Input #2
P50 / I/O03 - Digital Input #3
P52 / I/O05 - Relay #1
P53 / I/O06 - Relay #2
P54 / I/O07 - Relay #3

⌘ **NOTE:** You must consult the wiring schematic for digital inputs and relay output configuration.

Resetting a Fault

4.7 Resetting a Fault

To reset from a fault condition, press [RESET].

Emergency Overload Reset

4.8 Emergency Overload Reset

To perform an emergency overload reset, press [RESET] and [DOWN]. This sets the motor thermal overload content to 0.

An alternative to this is to use a digital input:

For LED display P48, P49 or P50 EOL_r (E OL Reset).

For LCD display: I/O 01, I/O 02 or I/O 03 EOL_{reset} (E OL Reset).

See page 110: I/O Digital Input Configuration for more information.

4 - KEYPAD OPERATION

Remote LCD Keypad and Display

4.9 2x16 Remote LCD Keypad

Like the standard keypad, the remote LCD keypad has the same basic functions with enhancements that allow using plain text instead of codes and a menu structure instead of a straight line of parameters.

Additional keys have been added, such as [START], [STOP], and a [LEFT] arrow for moving the cursor around in the LCD display. Status indicators have been added, providing additional information for the starter operation.

The remote keypad is NEMA 13/IP65 when mounted directly on the door of an enclosure with the correct gasket.

Figure 23: Remote LCD Keypad



Description of the LEDs on the Keypad

4.10 Description of the LEDs on the Keypad

The keypad provides three LED indicators in addition to the 2x16 character display. The LEDs provide starter status information.

Table 17: Remote Keypad LED Functions

LED	State	Indication
STOP	On	Stopped
	Flashing	Faulted
RUN	On	Running and up-to-speed
	Flashing	Running and not up-to-speed (ramping, decelerating, braking etc).
ALARM	Flashing	Alarm condition exists. If condition persists, a fault occurs.







⚠ **NOTE:** By default, the [STOP] key is always active, regardless of selected control source (Local Source and Remote Source parameters). It may be disabled though using the Keypad Stop Disable (P65 / I/O 18) parameter. For more information refer to the Keypad Stop Disable (P65 / I/O 18) parameter on page 119.

Description of the Keys on the Remote LCD Keypad

4.11 Description of the Keys on the Remote LCD Keypad

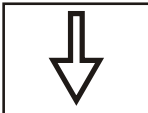
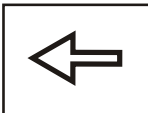
The [UP] arrow, [DOWN] arrow, [ENTER] and [MENU] keys on the LCD keypad perform the same functions as the [UP], [DOWN], [ENTER] and [PARAM] keys on the standard keypad. Three keys have been added, with one of the keys serving a dual function.

Table 18: Function of the Keys on the LCD Keypad

Key	Function
	<ul style="list-style-type: none"> • This key causes the starter to begin the start sequence. The direction is dependent on wiring and phase selection. • In order for this key to work, the Local Source (QST 04) parameter must be set to "Keypad".
	<ul style="list-style-type: none"> • Increase the value of a numeric parameter. • Select the next value of an enumerated parameter. • It scrolls forward through a list of parameters within a group (when the last parameter is displayed, it scrolls to the beginning of the list). • When a list of faults is displayed, it moves from one fault to the next. • When the starter is in the Operate Mode, pressing [UP] allows you to change which group of meter values is monitored.
	<ul style="list-style-type: none"> • Decrease the value of a numeric parameter. • Select the previous value of an enumerated parameter. • It scrolls backward through a list of parameters within a group (when the first parameter is displayed, it scrolls to the end of the list). • When a list of faults is displayed, it moves from one fault to the previous fault. • When the starter is in the Operate Mode, pressing [DOWN] allows you to change which group of meter values is monitored.
	<ul style="list-style-type: none"> • When editing a numeric parameter, the [LEFT] arrow key moves the cursor one digit to the left. If cursor is already at the most significant digit, it returns to the least significant digit on the right. • When in Menu mode, the [LEFT] arrow allows groups to be scrolled through in the opposite direction of the [MENU] Key.
	<ul style="list-style-type: none"> • Allows editing a parameter. Stores the change of a parameter. • When in Fault History, [ENTER] key scrolls through information logged when a fault occurred. • When an alarm condition exists, [ENTER] scrolls through all active alarms.
	<ul style="list-style-type: none"> • [MENU] scrolls between the operate screen and the available parameter groups. • When viewing a parameter, pressing [MENU] jumps to the top of the menu. • When a parameter is being edited and [MENU] is pressed, the change is aborted and the parameter's old value is displayed.
	<ul style="list-style-type: none"> • The [STOP/RESET] key halts the operation of the starter (Stop Key). • If a fault has occurred, the [STOP/RESET] key is used to clear the fault. • The [STOP] key may be disabled using the Keypad Stop Disable (I/O 18) parameter, if the control source (QST 04/QST 05) is not set to "Keypad". The [STOP/RESET] key always halts the operation of the starter if the control source is set to "Keypad". If the control source (QST 04/QST 05) is not set to "Keypad".

4 - KEYPAD OPERATION

Jump Code

4.12 Jump Code

At the beginning of each parameter group, there is a Jump Code parameter. By changing the value of this parameter and pressing [ENTER], you can jump directly to any parameter within that group.

Alphanumeric Display

4.13 Alphanumeric Display

The remote LCD keypad and display uses a 32-character alphanumeric LCD display. All starter functions can be accessed by the keypad. The keypad allows easy access to starter programming with parameter descriptions on the LCD display.

Power UP Screen

On power up, the software part number is displayed for five seconds. Pressing any key immediately changes the display to the operate screen.

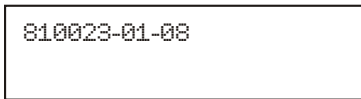

Operate Screen

The operate screen is the main screen. The Operate screen is used to indicate the status of the starter, if it's running, what state it's in, and display the values of Meter 1 and Meter 2, which are selectable.

The Operate Screen is divided into five sections.

- Sections A and B display status information
- Section C and D displays the meter selected by the Meter 1 and 2 parameters, see FUN 01, 02.
- Section S displays the source for the start command.

Figure 24: Operate Screen

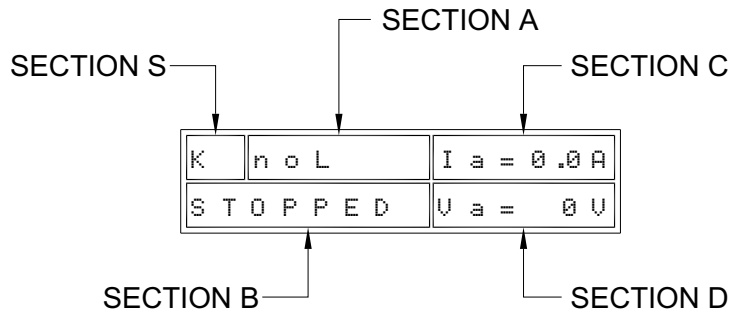

Table 19: Operate Screen Section A

Display	Description
NoL	L1, L2, L3 not present
Ready	Starter ready to run
Alarm	A fault condition is present. If it continues, a fault occurs
Run	Starter is running

Table 20: Operate Screen Section B

Display	Description
Stopped	Starter is stopped and no Faults
Fault	Starter tripped on a Fault
Heater	Starter is on and heating motor
Kick	Starter is applying kick current to the motor
Accel	Starter is accelerating the load
Kick 2	Starter is applying kick current to the motor in Ramp 2
Accel 2	Starter is accelerating the load in Ramp 2
Run	Starter is in Run mode and Ramp Time has expired
UTS	Starter is Up To Speed
Control	Phase Control or Current Follower mode
Decel	Starter is decelerating the load
Wye	In Wye-delta control indicates motor is accelerating in Wye mode
Slow Spd Fwd	Preset slow speed forward
Slow Spd Rev	Preset slow speed reverse
Braking	DC Injection Braking.
Lockout	Starter is Locked Out

Table 21: Operate Screen Section S

Display	Description
K	Keypad Control
T	Terminal Block Control
S	Serial Communication Control

4.13.1 Parameter Group Screens

From the operate screen, the parameter group screens are accessed by pressing either the menu or the left arrow keys. The parameter group screens display the different parameter groups; QST, CFN, PFN, I/O, FUN, FL_.

```

MMM: P P P P P P P P P P
MI U U U U U U U U U U
```

MMM: = Parameter Group
MI: = Menu Index
PPP: = Parameter Name
VVV: = Parameter Value and Units

Refer to Chapter 5 for a listing of the parameters and their ranges.

4 - KEYPAD OPERATION

4.13.2 Meter Pages

Although any meter may be viewed by changing the two Meter parameters (FUN 01 & FUN 02), there are 13 “Meter Pages” that are easily accessed to view all of the meter information. These meter pages are scrolled through by pressing the [UP] or [DOWN] down arrows from the operate screen.

Current I2= 0.0A I1= 0.0 I3= 0.0A	RSGndCur= 0%
Voltage V2= 0V V1= 0 V3= 0V	Lst STt Tim= xx.xs Pk ST Cur = xx.xA
MWatt Hour= 0 kWatt Hour= 0	Frequency = 60.0H Phase = AbC
Watts = 0 VA = 0	Run Days = xxxxx Run Hours =xxxxx
Motor PF =0.00 vars = 0	Analog In = 0.0% Analog Out= 0.0%
TruTorque = 0% Power = 0%	Starts = xxxxxx
Overload = 0% CurrInbal = 0.0%	

⌘ NOTE:	Run Hours	00:00 – 23:59
	Run Days	0 – 2730 days or 7.5 years
	kWatt Hours	0 – 999
	MWatt Hours	0 – 9999
	Starts	0 – 65535

4.13.3 Fault Log Screen

More information regarding each fault is available through the remote MX² LCD display than is available through the standard MX² LED display.

FL#:Fault## NNNNNNNNNNNN

FL_ = Fault Log Number. FL1 is the most recent fault and FL9 is the oldest fault.
 Fault__ = Fault Code
 NNN... = Fault Name, or the condition when the fault occurred.

4 - KEYPAD OPERATION

Press [MENU] until you get to the FL1 parameter.

Pressing the [UP] and [DOWN] keys navigates through older and newer faults in the log.

Repeatedly pressing the [ENTER] key rotates through the conditions the starter was in when the fault occurred.

Enter Step	
1	Fault Description.
2	Status when the fault occurred, Run, Stopped, Accel. etc.
3	The L1 current at the time of the fault.
4	The L2 current at the time of the fault.
5	The L3 current at the time of the fault.
6	L1-2 voltage at the time of the fault.
7	L2-3 voltage at the time of the fault.
8	L3-1 voltage at the time of the fault.
9	kW at the time of the fault.
10	Frequency at the time of the fault.
11	Run time since last run time reset.

4.13.4 Fault Screen

When a Fault occurs, the main screen is replaced with a fault screen. The screen shows the fault number and the name of the fault. The main status screen is not shown until the fault is reset.

When a fault occurs, the STOP LED flashes.

```

Fault##
Fault Name
    
```

⌘ **NOTE:** For a list of the Faults, refer to Appendix B - Fault Codes on page 196.

4.13.5 Lockout Screen

When a lockout is present, one of the following screens will be displayed. The main status screen is not shown until the lockout is cleared.

The overload lockout displays the overload content and the time until reset if an overload occurs.

```

Overload Lockout
96%          XXXX
    
```

The stack over temperature lockout will be displayed if a stack over temperature is detected

```

Stack Overload
Lockout
    
```

The control power lockout will be displayed if the control power is not within specifications.

```

Control Power
Lockout
    
```

The disconnect open lockout will be displayed if a digital input is programmed to "disconnect" and the input is off.

```

Disconnect Open
Lockout
    
```

A "Run Enable or Run Disable" digital input is set and is not true. See digital inputs on page 110

```

Run Interlock
Lockout
    
```

4.13.6 Alarm Screen

When an alarm is present, the word "Alarm" is displayed on the operate screen. Pressing the [ENTER] key displays more information about the alarm.

```

Alarm Number
Alarm Name
    
```

4 - KEYPAD OPERATION

Procedure for Setting Data

4.14 Procedure for Setting Data

Select a parameter that is to be changed. To change Motor FLA from 10 Amps to 30 Amps:

From the main screen:

```
T Ready Ia=0.0A
Stopped Va=480V
```

Press [MENU] key and the display shows QST: (Quick Start) screen.

```
QST: Jump Code
00 1
```

Press [UP] key once to Motor FLA (QST 01).

```
QST: Motor FLA
01 10Amp
```

Press [ENTER] key once, the cursor starts to flash in the one's place.

```
QST: Motor FLA
01 10Amp
```

Press [LEFT] key once, the cursor flashes in the ten's place.

```
QST: Motor FLA
01 10Amp
```

Press [UP] arrow to increase the value, for a value of 30, press twice.

```
QST: Motor FLA
01 30Amp
```

Press [ENTER] to store the value.

```
QST: Motor FLA
01 30Amp
```

Press [UP] arrow to change another parameter in QST.
Press [MENU] to change another parameter in another group.
Press [LEFT] arrow to go back to the main screen

5

Parameter Groups

5 - PARAMETER GROUPS

Introduction

5.1 Introduction

The MX² incorporates a number of parameters that allow you to configure the starter to meet the special requirements of your particular application. The parameters are organized two ways, depending on the display being used. When the standard, on-board LED display is used, the parameters are in a single group and numbered P1, P2, P3... etc.

When the remote LCD display is used, the parameters are divided into groups of related functionality, and within the groups the parameters are identified by a short, descriptive name. The parameters are subdivided into six groups. The groups are **QST** (Quick Start), **CFN** (Control Functions), **PFN** (Protection Functions), **I/O** (Input/Output Functions), **FUN** (Function) and **FLI** (Faults).

The Quick Start Group provides a collection of the parameters that are most commonly changed when commissioning a starter. Many of the parameters in the Quick Start group are duplicates of the parameters in the other groups.

This chapter lists all of the parameters and their possible values. Section 5.3 lists the parameters in the order in which they appear on the LED display. Section 5.4 lists them in the order in which they appear on the LCD display. Section 5.2 is a cross-reference between the two.

5 - PARAMETER GROUPS

LED & LCD Display Parameters Cross Reference

5.2 LED and LCD Display Parameters Cross Reference

Parameter Number	Group	Parameter Name	Page #	Parameter Number	Group	Parameter Name	Page #
P1	QST 01	Motor FLA	75	P42	PFN 11	Auto Reset Limit	104
P2	QST 02	Motor Service Factor	75	P43	PFN 12	Controlled Fault Stop Enable	105
P3	QST 03 PFN 15	Motor Running Overload Class	76	P44	PFN 13	Independent Starting/Running Overload	106
P4	QST 04	Local Source	77	P45	PFN 14	Motor Starting Overload Class	107
P5	QST 05	Remote Source	78	P46	PFN 16	Motor Overload Hot/Cold Ratio	108
P6	QST 06 CFN 03	Initial Current 1	79	P47	PFN 17	Motor Overload Cooling Time	109
P7	QST 07 CFN 04	Maximum Current 1	80	P48	I/O 01	DI 1 Configuration	110
P8	QST 08 CFN 02	Ramp Time 1	81	P49	I/O 02	DI 2 Configuration	110
P9	QST 09	Up To Speed Time	82	P50	I/O 03	DI 3 Configuration	110
P10	CFN 01	Start Mode	83	P51	I/O 04	Digital Fault Input Trip Time	111
P11	CFN 08	Initial Voltage/Torque/Power	84	P52	I/O 05	R1 Configuration	112
P12	CFN 09	Maximum Torque/Power	85	P53	I/O 06	R2 Configuration	112
P13	CFN 10	Kick Level 1	86	P54	I/O 07	R3 Configuration	112
P14	CFN 11	Kick Time 1	86	P55	I/O 08	Analog Input Trip Type	113
P15	CFN 14	Stop Mode	87	P56	I/O 09	Analog Input Trip Level	114
P16	CFN 15	Decel Begin Level	88	P57	I/O 10	Analog Input Trip Time	114
P17	CFN 16	Decel End Level	89	P58	I/O 11	Analog Input Span	115
P18	CFN 17	Decel Time	90	P59	I/O 12	Analog Input Offset	116
P19	CFN 18	DC Brake Level	91	P60	I/O 13	Analog Output Function	116
P20	CFN 19	DC Brake Time	92	P61	I/O 14	Analog Output Span	117
P21	CFN20	DC Brake Delay	93	P62	I/O 15	Analog Output Offset	117
P22	CFN 06	Initial Current 2	93	P63	I/O 16	Inline Configuration	118
P23	CFN 07	Maximum Current 2	93	P64	I/O 17	Bypass Feedback Time	118
P24	CFN 05	Ramp Time 2	94	P65	I/O 18	Keypad Stop Disable	119
P25	CFN 12	Kick Level 2	94	P66	I/O 19	Power On Start Selection	119
P26	CFN 13	Kick Time 2	94	P67	FUN 15	Miscellaneous Commands	120
P27	CFN 21	Slow Speed	95	P68	FUN 12	Communication Timeout	121
P28	CFN 22	Slow Speed Current Level	95	P69	FUN 11	Communication Baud Rate	121
P29	CFN 23	Slow Speed Time Limit	96	P70	FUN 10	Communication Address	121
P30	CFN 24	Slow Speed Kick Level	96	P71	FUN 13	Communication Byte Framing	122
P31	CFN 25	Slow Speed Kick Time	97	P72	FUN 09	Energy Saver	122
P32	PFN 01	Over Current Level	98	P73	FUN 08	Heater Level	123
P33	PFN 02	Over Current Time	99	P74	FUN 07	Starter Type	124
P34	PFN 03	Under Current Level	100	P75	FUN 06	Rated Power Factor	125
P35	PFN 04	Under Current Time	100	P76	FUN 05	Rated Voltage	125
P36	PFN 05	Current Imbalance Level	101	P77	FUN 04	Phase Order	126
P37	PFN 06	Residual Ground Fault Level	102	P78	FUN 03	CT Ratio	126
P38	PFN 07	Over Voltage Level	103	P79	FUN 01	Meter 1	127
P39	PFN 08	Under Voltage Level	103	n/a	FUN 02	Meter 2	127
P40	PFN 09	Voltage Trip Time	104	P80	FUN 14	Software Version 1	128
P41	PFN 10	Auto Fault Reset Time	104	P81	FUN 16	Passcode	129
				P82	FL1	Fault Log	130

5 - PARAMETER GROUPS

LED Display Parameters

5.3 LED Display Parameters

Number	Parameter	Setting Range	Units	Default	Page
P1	Motor FLA	1 – 6400	RMS Amps	10	75
P2	Motor Service Factor	1.00 – 1.99		1.15	75
P3	Motor Running Overload Class	Off, 1 – 40		10	76
P4	Local Source	PAd: Keypad tEr: Terminal SEr: Serial		tEr	77
P5	Remote Source				78
P6	Initial Motor Current 1	50 – 600	%FLA	100	79
P7	Maximum Motor Current 1	100 – 800	%FLA	600	80
P8	Ramp Time 1	0 – 300	Seconds	15	81
P9	Up To Speed Time	1 – 900	Seconds	20	82
P10	Start Mode	oLrP: Voltage Ramp curr: Current Ramp tt: TT Ramp Pr: Power Ramp		curr	83
P11	Initial Voltage/Torque/Power	1 – 100	%	25	84
P12	Maximum Torque/Power	10 – 325	%	105	85
P13	Kick Level 1	Off, 100 to 800	%FLA	Off	86
P14	Kick Time 1	0.1 – 10.0	Seconds	1.0	86
P15	Stop Mode	CoS: Coast SdcL: Volt Decel tdcL: TT Decel dcb: DC Braking		CoS	87
P16	Decel Begin Level	100 – 1	%	40	88
P17	Decel End Level	99 – 1	%	20	89
P18	Decel Time	1 – 180	Seconds	15	90
P19	DC Brake Level	10 – 100	%	25	91
P20	DC Brake Time	1 – 180	Seconds	5	92
P21	DC Brake Delay	0.1 – 3.0	Seconds	0.2	93
P22	Initial Motor Current 2	50 – 600	%FLA	100	93
P23	Maximum Motor Current 2	100 – 800	%FLA	600	93
P24	Ramp Time 2	0 – 300	Seconds	15	94
P25	Kick Level 2	Off, 100 – 800	%FLA	Off	94
P26	Kick Time 2	0.1 – 10.0	Seconds	1.0	94
P27	Slow Speed	Off, 7.1 14.3	%	Off	95
P28	Slow Speed Current Level	10 – 400	%FLA	100	95
P29	Slow Speed Time Limit	Off, 1 – 900	Seconds	10	96
P30	Slow Speed Kick Level	Off, 100 – 800	%FLA	Off	96
P31	Slow Speed Kick Time	0.1 – 10.0	Seconds	1.0	97
P32	Over Current Trip Level	Off, 50 – 800	%FLA	Off	98
P33	Over Current Trip Delay Time	Off, 0.1 – 90.0	Seconds	0.1	99
P34	Under Current Trip Level	Off, 5 – 100	%FLA	Off	100
P35	Under Current Trip Delay Time	Off, 0.1 – 90.0	Seconds	0.1	100
P36	Current Imbalance Trip Level	Off, 5 – 40	%	15	101
P37	Residual Ground Fault Trip Level	Off, 5 – 100	%FLA	Off	102
P38	Over Voltage Trip Level	Off, 1 – 40	%	Off	103
P39	Under Voltage Trip Level	Off, 1 – 40	%	Off	103
P40	Over/Under Voltage Trip Delay Time	0.1 – 90.0	Seconds	0.1	104

5 - PARAMETER GROUPS

Number	Parameter	Setting Range	Units	Default	Page
P41	Auto Fault Reset Time	Off, 1 – 900	Seconds	Off	104
P42	Auto Reset Limit	Off, 1 – 10		Off	104
P43	Controlled Fault Stop Enable	Off, On		On	105
P44	Independent Starting/Running Overload	Off, On		Off	106
P45	Motor Starting Overload Class	Off, 1 – 40		10	107
P46	Motor Overload Hot/Cold Ratio	0 – 99	%	60	108
P47	Motor Overload Cooling Time	1.0 – 999.9	Minutes	30.0	109
P48	DI 1 Configuration	OFF: Off StOP: Stop FH: Fault High FL: Fault Low Fr: Fault Reset diSc: Disconnect InLn: Inline Cnfrm byP: Bypass Cnfrm EoLr: E OL Reset L-r: Local/Remote hdIS: Heat Disable hEn: Heat Enable rSEL: Ramp Select SS F: Slow Speed Forward		Stop	110
P49	DI 2 Configuration	SS R: Slow Speed Reverse bdIS: DC Brake Disable bEn: DC Brake Enable runE Run Enable rund Run Disable		Off	
P50	DI 3 Configuration			Off	
P51	Digital Fault Input Trip Time	0.1 – 90.0	Seconds	0.1	111
P52	R1 Configuration	OFF: Off FLFS: Fault (fail safe) FLnF: Fault (non fail safe) run: Running utS: UTS AL: Alarm rdyr: Ready LOC: Locked Out OC: Over Current UC: Under Current OLA: OL Alarm ShFS: Shunt Trip (fail safe) ShnF: Shunt Trip (non fail safe) gfLt: Ground Fault ES: Energy Saver HEAt: Heating SSPd: Slow Speed SS F: Slow Speed Forward SS r: Slow Speed Reverse deb: DC Braking FAn: Cooling Fan		FLFS	112
P53	R2 Configuration			Off	
P54	R3 Configuration			Off	
P55	Analog Input Trip Type	Off: Disabled Lo: Low Level Hi: High Level		Off	113
P56	Analog Input Trip Level	0 – 100	%	50	114
P57	Analog Input Trip Delay Time	0.1 – 90.0	Seconds	0.1	114
P58	Analog Input Span	1 – 100	%	100	115
P59	Analog Input Offset	0 – 99	%	0	116

5 - PARAMETER GROUPS

Number	Parameter	Setting Range	Units	Default	Page
P60	Analog Output Function	0: Off (no output) 1: 0 – 100% Curr 2: 0 – 200% Curr 3: 0 – 800% Curr 4: 0 – 150% Volt 5: 0 – 150% OL 6: 0 – 10 kW 7: 0 – 100 kW 8: 0 – 1 MW 9: 0 – 10 MW 10: 0 – 100% Ain 11: 0 – 100% Firing 12: Calibration		0: Off (no output)	116
P61	Analog Output Span	1 – 125	%	100	117
P62	Analog Output Offset	0 – 99	%	0	117
P63	Inline Configuration	Off, 1.0– 10.0	Seconds	3.0	118
P64	Bypass Feedback Time	Off, 0.1 – 5.0	Seconds	2.0	118
P65	Keypad Stop Disable	On, OFF		On	119
P66	Power On Start Selection	0: Disabled 1: Start after power applied only 2: Start after fault reset only 3: Start after power applied and after fault reset		0	119
P67	Miscellaneous Commands	0: None 1: Std. BIST 2: Powered BIST 3: Reset Run Time 4: Reset KWh/MWh 5: Enter Reflash mode 6: Store Parameters 7: Load Parameters 8: Factory Reset		0	120
P68	Communication Timeout	Off, 1 – 120	Seconds	Off	121
P69	Communication Baud Rate	1200, 2400, 4800, 9600, 19200	bps	19.2	121
P70	Communication Address	1 – 247		1	121
P71	Communication Byte Framing	0: Even Parity, 1 Stop Bit 1: Odd Parity, 1 Stop Bit 2: No Parity, 1 Stop Bit 3: No Parity, 2 Stop Bits		0	122
P72	Energy Saver	Off, On		Off	122
P73	Heater Level	Off, 1 – 40	%FLA	Off	123
P74	Starter Type	nor: Normal Id: Inside Delta y-d: Wye-Delta / Other Electro mechanical PctL: Phase Control cFol: Current Follow ATL: Full Voltage ATL		nor	124
P75	Rated Power Factor	-0.01 (Lag) to 1.00 (Unity)		-0.92	125
P76	Rated Voltage	100, 110, 120, 200, 208, 220, 230, 240, 350, 380, 400, 415, 440, 460, 480, 500, 525, 575, 600, 660, 690, 800, 1000, 1140	RMS Voltage	480	125
P77	Phase Order	InS: Insensitive AbC: ABC CbA: CBA SPH: Single Phase		InS	126

5 - PARAMETER GROUPS

Number	Parameter	Setting Range	Units	Default	Page
P78	CT Ratio	72:1, 96:1, 144:1, 288:1, 864:1, 2640:1, 3900:1, 5760:1, 8000:1, 14400:1, 28800:1		288	126
P79	Meter	0: Status 1: Ave Current 2: L1 Current 3: L2 Current 4: L3 Current 5: Curr Imbal 6: Ground Fault 7: Ave Volts 8: L1-L2 Volts 9: L2-L3 Volts 10: L3-L1 Volts 11: Overload 12: Power Factor 13: Watts 14: VA 15: VARS 16: kW hours 17: MW hours 18: Phase Order 19: Line Freq 20: Analog Input 21: Analog Output 22: Run Days 23: Run Hours 24: Starts 25: TruTorque % 26: Power % 27: Peak Starting Current 28: Last Starting Duration		0	127
P80	Software Version 1	Display Only		810023-01-08	128
P81	Passcode			Off	129
P82	Fault Log	1FXX - 9FXX		XFXX	130

5 - PARAMETER GROUPS

LCD Display Parameters

5.4 LCD Display Parameters

The 2x16 display has the same parameters available as the LED display, with the exception of two meter parameters instead of one since two meters may be displayed on the main screen. The parameters are subdivided into five groups. The groups are **QST** (Quick Start), **CFN** (Control Functions), **I/O** (Input/Output Functions), **PFN** (Protection Functions) and **FUN** (Function).

The Quick Start Group provides a collection of the parameters that are most commonly changed when commissioning a starter. Many of the parameters in the Quick Start group are duplicates of the same parameters in other groups.

The MX² incorporates a number of parameters that allow you to configure the starter to meet the special requirements of your particular application.

The parameters are divided into groups of related functionality, and within the groups the parameters are identified by a short, descriptive name. They are numbered by the group name followed by an index within the group.

This chapter lists all of the parameters and their possible values.

The following shows the menu structure for the LCD display as well as the text that is displayed for the parameters on the display.

5.4.1 Quick Start Group

Number	Display	Parameter	Setting Range	Units	Default	Page
QST 00	Jump Code	Jump to Parameter	1 to 9		1	75
QST 01	Motor FLA	Motor FLA	1 to 6400	RMS Amps	10	75
QST 02	Motor SF	Motor Service Factor	1.00 to 1.99		1.15	75
QST 03	Running OL	Motor Overload Class Running	Off, 1 to 40		10	76
QST 04	Local Src	Local Source	Keypad Terminal Serial		Terminal	77
QST 05	Remote Src	Remote Source				78
QST 06	Init Cur 1	Initial Motor Current 1	50 to 600	%FLA	100	79
QST 07	Max Cur 1	Maximum Motor Current 1	100 to 800	%FLA	600	80
QST 08	Ramp Time 1	Ramp Time 1	0 to 300	Seconds	15	81
QST 09	UTS Time	Up To Speed Time	1 to 900	Seconds	20	82

5 - PARAMETER GROUPS

5.4.2 Control Function Group

Number	Display	Parameter	Setting Range	Units	Default	Page
CFN 00	Jump Code	Jump to Parameter	1 to 25		1	83
CFN 01	Start Mode	Start Mode	Voltage Ramp Current Ramp TT Ramp Power Ramp		Current Ramp	83
CFN 02	Ramp Time 1	Ramp Time 1	0 to 300	Seconds	15	81
CFN 03	Init Cur 1	Initial Motor Current 1	50 to 600	%FLA	100	79
CFN 04	Max Cur 1	Maximum Motor Current 1	100 to 800	%FLA	600	80
CFN 05	Ramp Time 2	Ramp Time 2	0 to 300	Seconds	15	94
CFN 06	Init Cur 2	Initial Motor Current 2	50 to 600	%FLA	100	93
CFN 07	Max Cur 2	Maximum Motor Current 2	100 to 800	%FLA	600	93
CFN 08	Init V/T/P	Initial Voltage/Torque/Power	1 to 100	%	25	84
CFN 09	Max T/P	Maximum Torque/Power	10 to 325	%	105	85
CFN 10	Kick Lvl 1	Kick Level 1	Off, 100 to 800	%FLA	Off	86
CFN 11	Kick Time 1	Kick Time 1	0.1 to 10.0	Seconds	1.0	86
CFN 12	Kick Lvl 2	Kick Level 2	Off, 100 to 800	%FLA	Off	94
CFN 13	Kick Time 2	Kick Time 2	0.1 to 10.0	Seconds	1.0	94
CFN 14	Stop Mode	Stop Mode	Coast Volt Decel TT Decel DC Brake		Coast	87
CFN 15	Decel Begin	Decel Begin Level	100 to 1	%	40	88
CFN 16	Decel End	Decel End Level	99 to 1	%	20	89
CFN 17	Decel Time	Decel Time	1 to 180	Seconds	15	90
CFN 18	Brake Level	DC Brake Level	10 to 100	%	25	91
CFN 19	Brake Time	DC Brake Time	1 to 180	Seconds	5	92
CFN 20	Brake Delay	DC Brake Delay	0.1 to 3.0	Seconds	0.2	93
CFN 21	SSpd Speed	Slow Speed	Off, 7.1, 14.3	%	Off	95
CFN 22	SSpd Curr	Slow Speed Current Level	10 to 400	% FLA	100	95
CFN 23	SSpd Timer	Slow Speed Time Limit	Off, 1 to 900	Seconds	10	96
CFN 24	SSpd Kick Curr	Slow Speed Kick Level	Off, 100 to 800	% FLA	Off	96
CFN 25	SSpd Kick T	Slow Speed Kick Time	0.1 to 10.0	Seconds	1.0	97

5 - PARAMETER GROUPS

5.4.3 Protection Group

Number	Display	Parameter	Setting Range	Units	Default	Page
PFN 00	Jump Code	Jump to Parameter	1 to 17		1	98
PFN 01	Over Cur Lvl	Over Current Trip Level	Off, 50 to 800	%FLA	Off	98
PFN 02	Over Cur Tim	Over Current Trip Delay Time	Off, 0.1 to 90.0	Seconds	0.1	99
PFN 03	Undr Cur Lvl	Under Current Trip Level	Off, 5 to 100	%FLA	Off	100
PFN 04	Undr Cur Tim	Under Current Trip Delay Time	Off, 0.1 to 90.0	Seconds	0.1	100
PFN 05	Cur Imbl Lvl	Current Imbalance Trip Level	Off, 5 to 40	%	15	101
PFN 06	Gnd Flt Lvl	Residual Ground Fault Trip Level	Off, 5 to 100	%FLA	Off	102
PFN 07	Over Vlt Lvl	Over Voltage Trip Level	Off, 1 to 40	%	Off	103
PFN 08	Undr Vlt Lvl	Under Voltage Trip Level	Off, 1 to 40	%	Off	103
PFN 09	Vlt Trip Tim	Over/Under Voltage Trip Delay Time	0.1 to 90.0	Seconds	0.1	104
PFN 10	Auto Reset	Auto Fault Reset Time	Off, 1 to 900	Seconds	Off	104
PFN 11	Auto Rst Lim	Auto Reset Limit	Off, 1 to 10		Off	104
PFN 12	Ctrl Flt En	Controlled Fault Stop Enable	Off, On		On	105
PFN 13	Indep S® OL	Independent Starting/Running Overload	Off, On		Off	106
PFN 14	Starting OL	Motor Overload Class Starting	Off, 1 to 40		10	107
PFN 15	Running OL	Motor Overload Class Running	Off, 1 to 40		10	76
PFN 16	OL H© Ratio	Motor Overload Hot/Cold Ratio	0 to 99	%	60	108
PFN 17	OL Cool Tim	Motor Overload Cooling Time	1.0 to 999.9	Minutes	30.0	109

5.4.4 I/O Group

Number	Display	Parameter	Setting Range	Units	Default	Page
I/O 00	Jump Code	Jump to parameter	1 to 19		1	110
I/O 01	DI 1 Config	DI 1 Configuration	Off		Stop	110
I/O 02	DI 2 Config	DI 2 Configuration	Stop Fault High Fault Low Fault Reset Disconnect Inline Cnfrm Bypass Cnfrm E OL Reset Local/Remote Heat Disable Heat Enable Ramp Select Slow Spd Fwd Slow Spd Rev Brake Disabl Brake Enable Run Enable Run Disable		Off	
I/O 03	DI 3 Config	DI 3 Configuration				
I/O 04	Din Trp Time	Digital Fault Input Trip Time	0.1 to 90.0	Seconds	0.1	111

5 - PARAMETER GROUPS

Number	Display	Parameter	Setting Range	Units	Default	Page
I/O 05	R1 Config	R1 Configuration (Relay #1)	Off		Fault FS	112
I/O 06	R2 Config	R2 Configuration (Relay #2)	Fault FS (Fail Safe) Fault NFS (Non Fail Safe)		Off	
I/O 07	R3 Config	R3 Configuration (Relay #3)	Running UTS Alarm Ready Locked Out Overcurrent Undercurrent OL Alarm Shunt Trip FS Shunt Trip NFS Ground Fault Energy Saver Heating Slow Spd Slow Spd Fwd Slow SPd Rev Braking Cool Fan Ctl		Off	
I/O 08	Ain Trp Type	Analog Input Trip Type	Off Low Level High Level		Off	113
I/O 09	Ain Trp Lvl	Analog Input Trip Level	0 to 100	%	50	114
I/O 10	Ain Trp Tim	Analog Input Trip Delay Time	0.1 to 90.0	Seconds	0.1	114
I/O 11	Ain Span	Analog Input Span	1 to 100	%	100	115
I/O 12	Ain Offset	Analog Input Offset	0 to 99	%	0	116
I/O 13	Aout Fctn	Analog Output Function	Off 0 – 100% Curr 0 – 200% Curr 0 – 800% Curr 0 – 150% Volt 0 – 150% OL 0 – 10 kW 0 – 100 kW 0 – 1 MW 0 – 10 MW 0 – 100% Ain 0 – 100% Firing Calibration		Off	116
I/O 14	Aout Span	Analog Output Span	1 to 125	%	100	117
I/O 15	Aout Offset	Analog Output Offset	1 to 99	%	0	117
I/O 16	Inline Cnfg	In Line Configuration	Off, 1.0 to 10.0	Seconds	3.0	118
I/O 17	Bypas Fbk Tim	Bypass / 2M Confirm	Off, 0.1 to 5.0	Seconds	2.0	118
I/O 18	Kpd Stop Dis	Keypad Stop Disable	Enabled, Disabled		Enabled	119
I/O 19	Auto Start	Power On Start Selection	Disabled Power Fault Power and Fault		Disabled	119

5 - PARAMETER GROUPS

5.4.5 Function Group

Number	Display	Parameter	Setting Range	Units	Default	Page
FUN 00	Jump Code	Jump to parameter	1 to 16		1	120
FUN 01	Meter 1	Meter 1	Ave Current		Ave Current	127
FUN 02	Meter 2	Meter 2	L1 Current L2 Current L3 Current Curr Imbal Ground Fault Ave Volts L1-L2 Volts L2-L3 Volts L3-L1 Volts Overload Power Factor Watts VA vars kW hours MW hours Phase Order Line Freq Analog Input Analog Output Run Days Run Hours Starts TruTorque % Power % Pk Accel Cur Last Start T		Ave Volts	
FUN 03	CT Ratio	CT Ratio	72:1, 96:1, 144:1, 288:1, 864:1, 2640:1, 3900:1, 5760:1, 8000:1, 14400:1, 28800:1		288:1	126
FUN 04	Phase Order	Input Phase Sensitivity	Insensitive ABC CBA Single Phase		Insensitive	126
FUN 05	Rated Volts	Rated RMS Voltage	100, 110, 120, 200, 208, 220, 230, 240, 350, 380, 400, 415, 440, 460, 480, 500, 525, 575, 600, 660, 690, 800, 1000, 1140	RMS Voltage	480	125
FUN 06	Motor PF	Motor Rated Power Factor	-0.01 (Lag) to 1.00 (Unity)		-0.92	125
FUN 07	Starter Type	Starter Type	Normal Inside Delta Wye-Delta Phase Ctl Curr Follow ATL	%	Normal	124
FUN 08	Heater Level	Heater Level	Off, 1 to 40	%FLA	Off	123
FUN 09	Energy Saver	Energy Saver	Off, On	Seconds	Off	122
FUN 10	Com Drop #	Communication Address	1 to 247		1	121
FUN 11	Com Baud rate	Communication Baud Rate	1200 2400 4800 9600 19200	bps	19200	121
FUN 12	Com Timeout	Communication Timeout	Off, 1 to 120	Seconds	Off	121

5 - PARAMETER GROUPS

Number	Display	Parameter	Setting Range	Units	Default	Page
FUN 13	Com Parity	Communications Byte Framing	Even, 1 Stop Bit Odd, 1 Stop Bit None, 1 Stop Bit None, 2 Stop Bit		Even, 1 Stop	122
FUN 14	Software 1	Software 1 Part Number	Display Only		810023-01-08	128
FUN 15	Misc Command	Miscellaneous Commands	None Std BIST Powered BIST Reset RT Reset kWh Reflash Mode Store Params Load Params Factory Rst		None	120
FUN 16	Passcode	Passcode			Off	129

5.4.6 LCD Fault Group

Group	Fault Number	Fault Description	Starter State	I1	I2	I3	V1	V2	V3	kW	Hz	Run Time
FL1												
FL2												
FL3												
FL4												
FL5												
FL6												
FL7												
FL8												
FL9												

5.4.7 LED Fault Group

Group	Fault Number	Fault Description	Fault Number	Fault Description
F1			F6	
F2			F7	
F3			F8	
F4			F9	
F5				

5 - PARAMETER GROUPS

NOTES:

6 Parameter Description

6 - PARAMETER DESCRIPTION

Parameter Descriptions

6.1 Parameter Descriptions

The detailed parameter descriptions in this chapter are organized in the same order as they appear on the LED display. If the remote LCD display is being used, the table in chapter 5 beginning on page 62 can be used to find the page number of the parameter in this chapter.

Each parameter has a detailed description that is displayed with the following format.

P__	Parameter Name	MMM__
-----	----------------	-------

LED Display



LCD Display

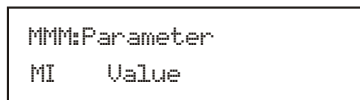

Range

Parameter Value (Default: Constant)

OR

LED **LCD**
EEE Keypad

Description

The description of the function.

See Also

Cross references to related parameters or other chapters.

In the above format, the header box for the parameter contains the P number (as it appears in the menu on the LED display), the parameter name and the parameter group number (as it appears in the menu on the LCD display).

The **LCD Display** section shows an example of what actually appears on the remote mounted keypad. The LED display shows an example of what actually appears on the built in display. The parameter group (represented above by “MMM”) and the (possibly abbreviated) parameter name are shown on the first line. The parameter group number (represented above by “MI” for “menu index”) and the parameter’s value and units are shown on the second line.

Some parameters appear in two different menus of the LCD display. This is the case for those parameters that are in the Quick Start Group. In this case, both LCD menu groups are listed in the header box and two example LCD displays are shown.

For some parameters, the **Range** section is enough to describe the parameter. For others, there may be an additional **Options** section to describe each of the options that a parameter may be set to. The form that the options take may be different for the LED and LCD displays, so this section shows how the options appear on both displays.

The **See Also** section lists cross-references to other parameters that may be related as well as references to further detail in other chapters.

6 - PARAMETER DESCRIPTION

Jump to Parameter

QST 00

By changing the value of this parameter and pressing [ENTER], you can jump directly to any parameter within that group.

P1

Motor FLA

QST 01

LED Display



LCD Display:



Range

Model Dependent, 1 – 6400 Amps RMS (Default 10A)

Description

The Motor FLA parameter configures the motor full load amps and is obtained from the nameplate on the attached motor.

If multiple motors are connected, the FLA of each motor must be added together for this value.

⚠ **NOTE:** Incorrectly setting this parameter prevents proper operation of the motor overload protection, motor over current protection, motor undercurrent protection, ground fault protection and acceleration control.

P2

Motor Service Factor

QST 02

LED Display



LCD Display

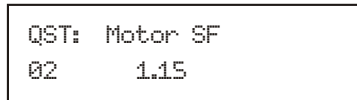

Range

1.00 – 1.99 (Default 1.15)

Description

The Motor Service Factor parameter should be set to the service factor of the motor. The service factor is used for the overload calculations. If the service factor of the motor is not known, then the service factor should be set to 1.00.

⚠ **NOTE:** The NEC (National Electrical Code) does not allow the service factor to be set above 1.40. Check with other local electrical codes for their requirements.

The National Electrical Code, article 430 Part C, allows for different overload multiplier factors depending on the motor and operating conditions. NEC section 430-32 outlines the allowable service factor for different motors.

See Also

Theory of Operation section 7.2, Motor Service Factor on page 139.

6 - PARAMETER DESCRIPTION

P3

Motor Overload Class Running

QST 03, PFN 15

LED Display



LCD Display

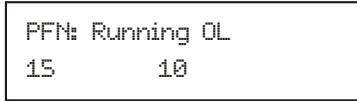
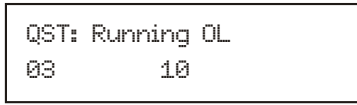

Range

Off, 1– 40 (Default 10)

Description

The Motor Running Overload Class parameter sets the class of the electronic overload for starting and running. If separate starting versus running overload classes are desired, set the independent S/R O/L (P44 / PFN13) parameter to "On".

The starter stores the thermal overload value as a percentage value between 0 and 100%, with 0% representing a "cold" overload and 100% representing a tripped overload. See section 7.1, for the overload trip time versus current curves.

When the parameter is set to "Off", the electronic overload is disabled when up to speed and a separate motor overload protection device must be supplied.

⚠ **NOTE:** Care must be taken not to damage the motor when turning the running overload class off or setting to a high value.

⚠ **NOTE:** Consult motor manufacturer data to determine the correct motor overload settings.

See Also

Independent Starting/Running Overload (P44 / PFN 13) on page 106.

Motor Starting Overload Class (P45 / PFN 14) on page 107.

Motor Overload Hot/Cold Ratio (P46 / PFN 16) on page 108.

Motor Overload Cooling Time (P47 / PFN 17) on page 109.

Relay Output Configuration (P52-54 / I/O 05 - 07) on page 112.

Theory of Operation section 7.1, Solid State Motor Overload Protection on page 132.

6 - PARAMETER DESCRIPTION

P4	Local Source	QST 04
-----------	---------------------	---------------

LED Display



LCD Display

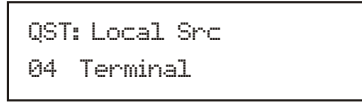

Range

LED	LCD	Description
P4d	Keypad	The start/stop control is from the keypad.
tEr	Terminal	The start/stop control is from the terminal strip inputs. (Default)
SER	Serial	The start/stop control is from the network.

Description

The MX² can have three sources of start and stop control; Terminal, Keypad and Serial. Two parameters, (P4 / QST 04) - Local Source and (P5 / QST 05) - Remote Source, allows the user to change the control source.

If a digital input is programmed as “L-r” (Local / Remote), then that input selects the control source. When the input is low, the local source is used. When the input is high, the remote source is used. If no digital input is programmed as “L-r”, then the local/remote bit in the starter control Modbus register selects the control source. The default value of the bit is Local (0).

See Also

- Remote Source (P5 / QST 05) parameter on page 78.
- Digital Input Configuration (P45-P50 / I/O 01- I/O 03) parameters on page 110.
- Keypad Stop Disable (P65 / I/O 18) parameter on page 119.
- Communication Timeout (P68 / FUN 12) parameter on page 121.
- Communication Baud Rate (P69 / FUN 11) parameter on page 121.
- Communication Address (P70 / FUN 10) parameter on page 121.

⚠ **NOTE:** By default, the Stop key is always enabled, regardless of selected control source. It may be disabled though using the P65 / I/O18 - Keypad Stop Disable parameter on page 119.

6 - PARAMETER DESCRIPTION

P5	Remote Source	QST 05
-----------	----------------------	---------------

LED Display



LCD Display

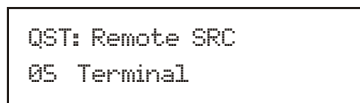

Range

LED	LCD	Description
PFd	Keypad	The start/stop control is from the keypad.
tEr	Terminal	The start/stop control is from the terminal strip inputs. (Default)
SEr	Serial	The start/stop control is from the network.

Description

The MX² can have three sources of start and stop control; Terminal, Keypad and Serial. Two parameters, (P4 / QST 04) - Local Source and (P5 / QST 05) - Remote Source, select the sources of the start and stop control.

If a digital input is programmed as “L-r” (Local / Remote), then that input selects the control source. When the input is low, the local source is used. When the input is high, the remote source is used. If no digital input is programmed as “L-r”, then the local/remote bit in the Modbus starter control register selects the control source. The default value of the bit is Local (0).

See Also

Local Source (P4 / QST 04) parameter on page 77.
 Digital Input Configuration (P45-P50 / I/O 01- I/O 03) parameters on page 110.
 Keypad Stop Disable (P65 / I/O 18) parameter on page 119.
 Communication Timeout (P68 / FUN 12) parameter on page 121.
 Communication Baud Rate (P69 / FUN 11) parameter on page 121.
 Communication Address (P70 / FUN 10) parameter on page 121.
 Modbus Register Map, refer to www.benshaw.com.

Figure 24: Local Remote Source

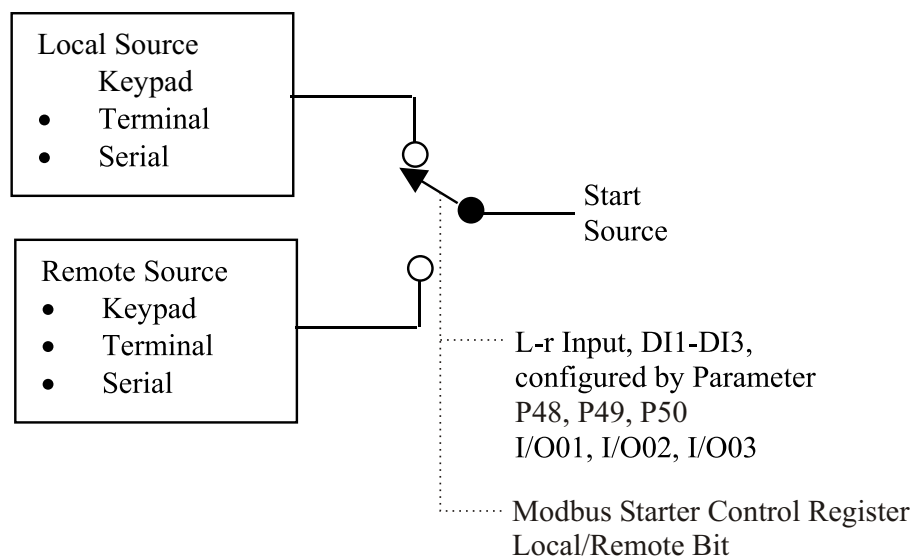

6 - PARAMETER DESCRIPTION

P6

Initial Motor Current 1

QST 06, CFN 03

LED Display



LCD Display

```
QST: Init Cur 1
06      100 %
```

```
CFN: Init Cur 1
03      100 %
```

Range

50 – 600 % of FLA (**Default 100%**)

Description

The Initial Motor Current 1 parameter is set as a percentage of the Motor FLA (P1 / QST 01) parameter setting. The Initial Current 1 parameter sets the current that is initially supplied to the motor when a start is commanded. The initial current should be set to the level that allows the motor to begin rotating within a couple of seconds of receiving a start command.

To adjust the initial current setting, give the starter a run command. Observe the motor to see how long it takes before it begins rotating and then stop the unit. For every second that the motor doesn't rotate, increase the initial current by 20%. Typical loads require an initial current in the range of 50% to 175%.

If the motor does not rotate within a few seconds after a start command, the initial current should be increased. If the motor accelerates too quickly after a start command, the initial current should be decreased.

The Initial Current 1 parameter must be set to a value that is lower than the Maximum Current 1 (P7 / QST 07) parameter setting.

See Also

Maximum Current 1 (P7 / QST 07) parameter on page 80.

Ramp Time 1 (P8 / QST 08) parameter on page 81.

Start Mode (P10 / CFN 01) parameter on page 83.

Kick Level 1 (P13 / CFN 10) parameter on page 86.

Kick Time 1 (P14 / CFN 11) parameter on page 86.

Theory of Operation section 7.3.1, Current Ramp Settings, Ramps and Times, on page 140.

6 - PARAMETER DESCRIPTION

P7

Maximum Motor Current 1

QST 07, CFN 04

LED Display



LCD Display

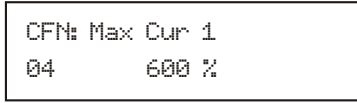
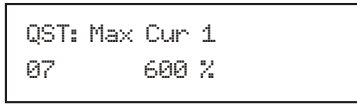

Range

100 – 800 % of FLA (**Default 600%**)

Description

The Maximum Motor Current 1 parameter is set as a percentage of the Motor FLA (P1 / QST 01) parameter setting. This parameter performs two functions. It sets the current level for the end of the ramp profile. It also sets the maximum current that is allowed to reach the motor after the ramp is completed.

If the ramp time expires before the motor has reached full speed, the starter holds the current at the maximum current level until either the UTS timer expires; the motor reaches full speed, or the overload trips.

Typically, the maximum current is set to 600% unless the power system or load dictates the setting of a lower or higher maximum current.

See Also

Initial Current 1 (P6 / QST 06) parameter on page 79.

Ramp Time 1 (P8 / QST 08) parameter on page 81.

Up To Speed Time (P9 / QST 09) parameter on page 82.

Start Mode (P10 / CFN 01) parameter on page 83.

Kick Level 1 (P13 / CFN 10) parameter on page 86.

Kick Time 1 (P14 / CFN 11) parameter on page 86.

Theory of Operation section 7.3.1, Current Ramp Settings, Ramps and Times on page 140.

6 - PARAMETER DESCRIPTION

P8

Ramp Time 1

QST 08, CFN 02

LED Display



LCD Display

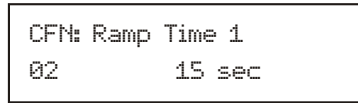
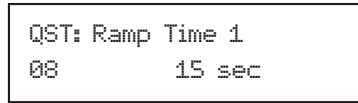

Range

0 – 300 seconds (**Default 15**)

Description

The Ramp Time 1 parameter is the time it takes for the starter to allow the current, voltage, torque or power (depending on the start mode) to go from its initial to the maximum value. To make the motor accelerate faster, decrease the ramp time. To make the motor accelerate slower, increase the ramp time.

A typical ramp time setting is from 15 to 30 seconds.

If the ramp time expires before the motor reaches full speed, the starter maintains the maximum current level until either the motor reaches full speed, the UTS timer expires, or the motor thermal overload trips.

⚠ **NOTE:** Setting the ramp time to a specific value does not necessarily mean that the motor will take this time to accelerate to full speed. The motor and load may achieve full speed before the ramp time expires if the application does not require the set ramp time and maximum current to reach full speed. Alternatively, the motor and load may take longer than the set ramp time to achieve full speed.

See Also

Initial Current 1 (P6 / QST 06) parameter on page 79.
Maximum Current 1 (P7 / QST 07) parameter on page 80.
Up To Speed Time (P9 / QST 09) parameter on page 82.
Start Mode (P10 / CFN 01) parameter on page 83.
Kick Level 1 (P13 / CFN 10) parameter on page 86.
Kick Time 1 (P14 / CFN 11) parameter on page 86.
Theory of Operation section 7.3.1, Current Ramp Settings, Ramps and Times on page 140.

6 - PARAMETER DESCRIPTION

P9

Up To Speed Time

QST 09

LED Display



LCD Display

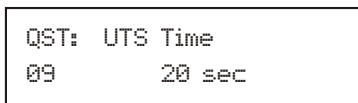

Range

1– 900 Seconds (**Default 20**)

Description

The Up To Speed Time parameter sets the maximum time the motor can take to accelerate to full speed. A stalled motor condition is detected if the motor does not get up-to-speed before the up-to-speed timer expires. The motor is considered up-to-speed once the current stabilizes below 175 percent of the FLA value and the ramp time expires.

⚠ **NOTE:** During normal acceleration ramps, the up-to-speed timer has to be greater than the sum of the highest ramp time in use and the kick time. The up-to-speed timer does not automatically change to be greater than the ramp time. If a ramp time greater than the up-to-speed timer is set, the starter will declare an up-to-speed fault every time a start is attempted.

⚠ **NOTE:** When the Start Mode (P10 / CFN 01) parameter is set to "Voltage Ramp", the UTS timer acts as an acceleration kick. When the UTS timer expires, full voltage is applied to the motor. This feature can be used to reduce motor oscillations if they occur near the end of an open loop voltage ramp start.

⚠ **NOTE:** When the Starter Type (P74 / FUN 07) parameter is set to "Wye-Delta", the UTS timer is used as the transition timer. When the UTS timer expires, the transition from Wye starting mode to Delta running mode takes place if it has not already occurred.

Fault Code 01 - Up to Speed Fault is declared when a stalled motor condition is detected.

See Also

Ramp Time 1 (P8 / QST 08) parameter on page 81.
Start Mode (P10 / CFN 01) parameter on page 83.
Kick Time 1 (P14 / CFN 11) parameter on page 86.
Ramp Time 2 (P24 / CFN 05) parameter on page 94.
Kick Time 2 (P26 / CFN 13) parameter on page 94.
Starter Type (P74 / FUN 07) parameter on page 124.
Theory of Operation section 7.3, Acceleration Control on page 140.
Theory of Operation section 7.8, Wye-Delta on page 160.

6 - PARAMETER DESCRIPTION

Jump to Parameter	CFN 00
--------------------------	---------------

By changing the value of this parameter and pressing [ENTER], you can jump directly to any parameter within that group.

P10	Start Mode	CFN 01
------------	-------------------	---------------

LED Display



LCD Display



Range

LED	LCD	Description
oLrP	Voltage Ramp	Open Loop Voltage acceleration ramp.
curr	Current Ramp	Current control acceleration ramp. (Default)
tt	TT Ramp	TruTorque control acceleration ramp.
Pr	Power Ramp	Power (kW) control acceleration ramp.

Description

The Start Mode parameter allows the selection of the optimal starting ramp profile based on the application.

The closed loop current control acceleration ramp is ideal for starting most general-purpose motor applications. Ex: crushers, ball mills, reciprocating compressors, saws, centrifuges, and most other applications.

The closed loop TruTorque control acceleration ramp is suitable for applications that require a smooth torque output from the motor during starting. Ex: centrifugal pumps, fans. The Tru Torque is also suitable for belt driven applications to eliminate belt sequel that commonly occurs near full speed.

The closed loop power control acceleration ramp is ideal for starting applications using a generator or other limited capacity source.

See Also

- Initial Current 1 (P6 / QST 06) parameter on page 79.
- Maximum Current 1 (P7 / QST 07) parameter on page 80.
- Ramp Time 1 (P8 / QST 08) parameter on page 81.
- Initial Voltage/Torque/Power (P11 / CFN 08) parameter on page 84.
- Kick Level 1 (P13 / CFN 10) parameter on page 86.
- Kick Time 1 (P14 / CFN 11) parameter on page 86.
- Theory of Operation section 7.3, Acceleration Control on page 140.

6 - PARAMETER DESCRIPTION

P11

Initial Voltage/Torque/Power

CFN08

LED Display

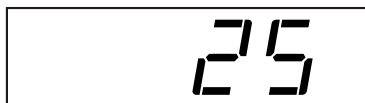

LCD Display

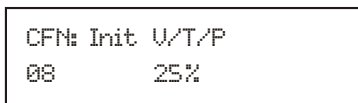

Range

1 – 100 % of Voltage/Torque/Power (**Default 25%**)

Description

Start Mode (P10/CFN01) set to Open Loop Voltage Acceleration:

This parameter sets the starting point for the voltage acceleration ramp profile. A typical value is 25%. If the motor starts too quickly or the initial current is too high, reduce this parameter. If the motor does not start rotating within a few seconds after a start is commanded, increase this parameter.

Start Mode (P10/CFN01) set to Current Control Acceleration:

Not used when the Start Mode parameter is set to Current control acceleration. Refer to the P6 - Initial Current 1 (CFN03) parameter to set the initial current level.

Start Mode (P10/CFN01) set to TruTorque Control Acceleration:

This parameter sets the initial torque level that the motor produces at the beginning of the starting ramp profile. A typical value is 10% to 20%. If the motor starts too quickly or the initial torque level is too high, reduce this parameter. If the motor does not start rotating within a few seconds after a start is commanded, increase this parameter. If the value is set too low a “No Current at Run” fault may occur during acceleration.

⚠ **NOTE:** It is important that the (P75 / FUN06) - Rated Power Factor parameter is set properly so that the actual initial torque level is the value desired.

Start Mode (P10/CFN01) set to (kW) Power Control Acceleration:

This parameter sets the initial motor power (KW) level that will be achieved at the beginning of the starting ramp profile. A typical value is 10% to 30%. If the motor starts too quickly or the initial power level is too high, reduce this parameter. If the motor does not start rotating within a few seconds after a start is commanded, increase this parameter. If the value is set too low a “No Current at Run” fault may occur during acceleration.

⚠ **NOTE:** It is important that the (P75 / FUN06) - Rated Power Factor parameter is set properly so that the actual initial power level is the value desired.

See Also

Initial Current 1 (P6 / QST 06) parameter on page 79.

Ramp Time 1 (P8 / QST 08) parameter on page 81.

Start Mode (P10 / CFN 01) parameter on page 83.

Maximum Torque/Power (P12 / CFN 09) parameter on page 85.

Rated Power Factor (P75 / FUN 06) parameter on page 125.

Theory of Operation section 7.3, Acceleration Control on page 140.

6 - PARAMETER DESCRIPTION

P12	Maximum Torque/Power	CFN 09
-----	----------------------	--------

LED Display



LCD Display

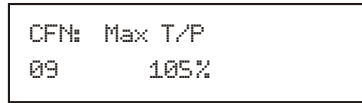

Range

10 – 325 % of Torque/Power (**Default 105%**)

Description

Start Mode (P10/CFN01) set to Open Loop Voltage Acceleration:

Not used when the Start Mode parameter is set to open-loop voltage acceleration. When in open loop voltage acceleration mode, the final voltage ramp value is always 100% or full voltage.

Start Mode (P10/CFN01) set to Current Control Acceleration:

Not used when the Start Mode parameter is set to Current control acceleration mode. Refer to the Maximum Current 1 (P7 / CFN04) parameter to set the maximum current level.

Start Mode (P10/CFN01) set to TruTorque Control Acceleration:

This parameter sets the final or maximum torque level that the motor produces at the end of the acceleration ramp time. For a loaded motor, the maximum torque value initially should be set to 100% or greater. If the maximum torque value is set too low, the motor may not produce enough torque to reach full speed and may stall. On lightly loaded motors, this parameter may be reduced below 100% to produce smoother starts.

⚠ **NOTE:** It is important that the (P75 / FUN06) - Rated Power Factor parameter is set properly so that the desired maximum torque level is achieved.

Start Mode (P10/CFN01) set to Power Control Acceleration:

This parameter sets the final or maximum power (KW) consumption level that will be achieved at the end of the ramp time. For a loaded motor, the maximum power value initially should be set to 100% or greater. If the maximum power level is set too low, the motor may not produce enough torque to reach full speed and may stall. On lightly loaded motors, this parameter may be reduced below 100% to provide for smoother starts.

⚠ **NOTE:** It is important that the (P75 / FUN06) - Rated Power Factor parameter is set properly so that the actual maximum power level is achieved.

See Also

Initial Current 1 (P6 / CFN03) on page 79.
Maximum Current 1 (P7 / QST 07) parameter on page 80.
Ramp Time 1 (P8 / QST 08) parameter on page 81.
Start Mode (P10 / CFN 01) parameter on page 83.
Initial Voltage/Torque/Power (P11 / CFN 08) parameter on page 84.
Rated Power Factor (P75 / FUN 06) parameter on page 125.
Theory of Operation section 7.3, Acceleration Control, on page 140.

6 - PARAMETER DESCRIPTION

P13

Kick Level 1

CFN 10

LED Display

The LED display shows the text "OFF" in a large, stylized, seven-segment font.

LCD Display

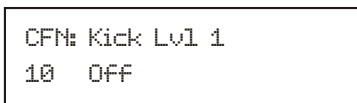
The LCD display shows two lines of text: "CFN: Kick Lvl 1" on the top line and "10 OFF" on the bottom line.

Range

Off, 100 – 800% of FLA (**Default Off**)

Description

The Kick Level 1 parameter sets the current level that precedes any ramp when a start is first commanded. The kick current is only useful on motor loads that are hard to get rotating but then are much easier to move once they are rotating. An example of a load that is hard to get rotating is a ball mill. The ball mill requires a high torque to get it to rotate the first quarter turn (90°). Once the ball mill is past 90° of rotation, the material inside begins tumbling and it is easier to turn.

The kick level is usually set to a low value and then the kick time is adjusted to get the motor rotating. If the kick time is set to more than 2.0 seconds without the motor rotating, increase the kick current by 100% and re-adjust the kick time.

See Also

Start Mode (P10 / CFN 01) parameter on page 83.
Kick Time 1 (P14 / CFN 11) parameter on page 86.
Theory of Operation section 7.3.2, Programming A Kick Current on page 141.

P14

Kick Time 1

CFN 11

LED Display

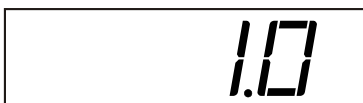
The LED display shows the text "1.0" in a large, stylized, seven-segment font.

LCD Display

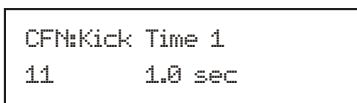
The LCD display shows two lines of text: "CFN:Kick Time 1" on the top line and "11 1.0 sec" on the bottom line.

Range

0.1 – 10.0 seconds (**Default 1.0**)

Description

The Kick Time 1 parameter sets the length of time that the kick current level (P13 / CFN 10) is applied to the motor.

The kick time adjustment should begin at 0.5 seconds and be adjusted by 0.1 or 0.2 second intervals until the motor begins rotating. If the kick time is adjusted above 2.0 seconds without the motor rotating, start over with a higher kick current setting.

⚠ **NOTE:** The kick time adds to the total start time and must be accounted for when setting the UTS time.

See Also

Start Mode (P10 / CFN 01) parameter on page 83.
Up To Speed (P9 / QST 09) parameter on page 82.
Kick Level 1 (P13 / CFN 10) parameter on page 86.
Theory of Operation section 7.3.2, Programming a Kick Current on page 141.

6 - PARAMETER DESCRIPTION

P15	Stop Mode	CFN 14
------------	------------------	---------------

LED Display



LCD Display



Range

LED	LCD	Description
Co5	Coast	Coast to stop. (Default)
SddL	Volt Decel	Open loop voltage deceleration.
tddL	TT Decel	TruTorque deceleration.
dcb	DC Brake	DC Braking.

Description

Coast:

A coast to stop should be used when no special stopping requirements are necessary; Example: crushers, balls mills, centrifuges, belts, conveyor. The bypass contactor is opened before the SCRs stop gating to reduce wear on the contactor contacts.

Voltage Decel:

In this mode, the starter linearly phases-back the SCRs based on the parameters Decel Begin Level, Decel End Level, and Decel Time.

TruTorque Decel:

In this mode, the starter linearly reduces the motor torque based on the Decel End Level and Decel Time.

DC Brake:

In this mode the starter provides D.C. injection for frictionless braking of a three phase motor.

⚠ **NOTE:** The MX² stops the motor when any fault occurs. Depending on the application, it may be desirable for the motor to be stopped in a controlled manner (Voltage Decel, TT Decel or D.C. Braking) instead of being allowed to coast to a stop when this occurs. This may be achieved by setting the Controlled Fault Stop Enable (P43 / PFN12) parameter to "On". Be aware, however, that not all fault conditions allow for a controlled fault stop.

See Also

- Decel Begin Level (P16 / CFN 15) parameter on page 88.
- Decel End Level (P17 / CFN 16) parameter on page 89.
- Decel Time (P18 / CFN 17) parameter on page 90.
- DC Brake Level (P19 / CFN 18) parameter on page 91.
- DC Brake Time (P20 / CFN 19) parameter on page 92.
- DC Brake Delay (P21 / CFN 20) parameter on page 93.
- Controlled Fault Stop Enable (P43 / PFN 12) parameter on page 105.
- Digital Input Configuration (P48-P50 / I/O 01-03) parameters on page 110.
- Relay Output Configuration (P52-P54 / I/O 05-07) parameters on page 112.
- Theory of Operation section 7.4, Deceleration Control on page 149.
- Theory of Operation section 7.5, Braking Controls on page 151.

6 - PARAMETER DESCRIPTION

P16

Decel Begin Level

CFN 15

LED Display

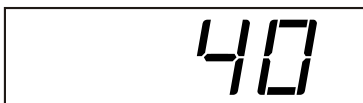

LCD Display

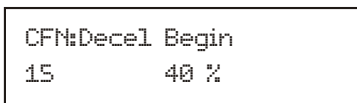

Range

1 % – 100% of phase angle firing (**Default 40%**)

Description

Stop Mode (P15/CFN14) set to Voltage Deceleration:

The voltage deceleration profile utilizes an open loop S-curve voltage ramp profile. The Decel Begin Level parameter sets the initial or starting voltage level when transferring from running to deceleration. The deceleration beginning level is not a precise percentage of actual line voltage, but defines a point on the S-curve deceleration profile.

A typical voltage decel begin level setting is between 30% and 40%. If the motor initially surges (oscillates) when a stop is commanded, decrease this parameter value. If there is a sudden drop in motor speed when a stop is commanded, increase this parameter value.

Stop Mode (P15/CFN14) set to TruTorque Deceleration:

Not used when the Stop Mode parameter is set to TruTorque Decel. The TruTorque beginning deceleration level is automatically calculated based on the motor load at the time the stop command is given.

⚠ **NOTE:** It is important that the (P75 / FUN06) - Rated Power Factor parameter is set properly so that the actual deceleration torque levels are the levels desired.

See Also

Stop Mode (P10 / CFN 14) parameter on page 87.

Decel End Level (P17 / CFN 16) parameter on page 89.

Decel Time (P18 / CFN 17) parameter on page 90.

Controlled Fault Stop Enable (P43 / PFN 12) parameter on page 105.

Rated Power Factor (P75 / FUN 06) parameter on page 125.

Theory of Operation section 7.4, Deceleration Control on page 149.

6 - PARAMETER DESCRIPTION

P17	Decel End Level	CFN 16
-----	-----------------	--------

LED Display



LCD Display

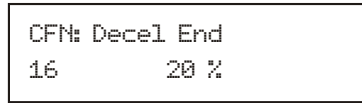

Range

1 – 99 % of phase angle firing (**Default 20%**)

Description

Stop Mode (P15/CFN14) set to Voltage Deceleration:

The voltage deceleration profile utilizes an open loop S-curve voltage ramp profile. The Decel End Level parameter sets the ending voltage level for the voltage deceleration ramp profile. The deceleration ending level is not a precise percentage of actual line voltage, but defines an ending point on the S-curve deceleration profile.

A typical voltage decel end level setting is between 10% and 20%. If the motor stops rotating before the deceleration time has expired, increase this parameter value. If the motor is still rotating when the deceleration time has expired, decrease this parameter value. If the value is set too low a “No Current at Run” fault may occur during deceleration.

⚠ **NOTE:** The deceleration end level cannot be set greater than the decel begin level.

Stop Mode (P15/CFN14) set to TruTorque Deceleration:

The decel end level parameter sets the ending torque level for the TruTorque deceleration ramp profile.

A typical TruTorque decel end level setting is between 10% and 20%. If the motor stops rotating before the deceleration time has expired, increase this parameter value. If the motor is still rotating when the deceleration time has expired, decrease this parameter value.

See Also

Stop Mode (P15 / CFN 14) parameter on page 87.
Decel Begin Level (P16 / CFN 15) parameter on page 88.
Decel Time (P18 / CFN 17) parameter on page 90.
Controlled Fault Stop Enable (P43 / PFN 12) parameter on page 105.
Theory of Operation section 7.4, Deceleration Control on page 149.

6 - PARAMETER DESCRIPTION

P18

Decel Time

CFN 17

LED Display

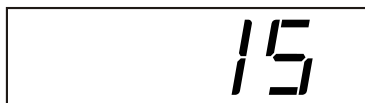

LCD Display

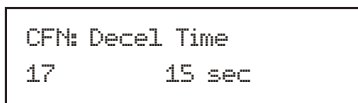

Range

1 – 180 seconds (**Default 15**)

Description

The Decel Time parameter sets the time that the deceleration profile is applied to the motor and sets the slope of the deceleration ramp profile. When in voltage decel mode, this time sets the time between applying the initial decel level to the final decel level.

⚠ **NOTE:** If the motor is not up to speed when a stop is commanded, the voltage decel profile begins at the lower of either the decel begin level setting or at the motor voltage level when the stop is commanded. Although the profile may be adjusted, the deceleration time remains the same.

When in the TruTorque deceleration mode, the decel time sets the time between when a stop is commanded and when the decel end torque level is applied.

If the motor stops rotating before the decel time expires, decrease the decel time parameter. If the motor is still rotating when the decel time expires, increase the decel time parameter.

A typical decel time is 20 to 40 seconds.

⚠ **NOTE:** Depending on the motor load and the decel parameter settings, the motor may or may not be fully stopped at the end of the deceleration time.

See Also

Stop Mode (P15 / CFN 14) parameter on page 87.

Decel Begin Level (P16 / CFN 15) parameter on page 88.

Decel End Level (P17 / CFN 16) parameter on page 89.

Controlled Fault Stop Enable (P43 / PFN 12) parameter on page 105.

Theory of Operation section 7.4, Deceleration Control on page 149.

6 - PARAMETER DESCRIPTION

P19	DC Brake Level	CFN 18
------------	-----------------------	---------------

LED Display



LCD Display

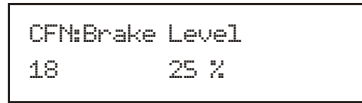

Range

10 – 100 % of available brake torque (**Default 25%**)

Description

When the Stop Mode (P15 / CFN 14) is set to DC brake, the DC Brake Level parameter sets the level of DC current applied to the motor during braking. The desired brake level is determined by the combination of the system inertia, system friction, and the desired braking time. If the motor is braking too fast the level should be reduced. If the motor is not braking fast enough the level should be increased. Refer to Nema MG1, Parts 12 and 20 for maximum load inertia. A Thermistor, Thermostat or RTD MUST be installed to protect the motor.

DC Brake Function Programming Steps:

1. The DC Brake function may be enabled by setting the stop mode (P15 / CFN 14) to DC Brake.
2. Once this function is enabled, a relay output configuration (P52,53,54 / I/O 05,06,07) must be used to control the DC brake contactor or 7th SCR gate drive card during braking. It is recommended to use Relay K3 - (P54 / I/O 07).

⌘ NOTE: Standard braking

- For load inertia less than 6 x motor inertia

⌘ NOTE: Heavy duty braking

- For NEMA MG1 parts 12 and 20 maximum load inertia

⌘ NOTE: When DC injection braking is utilized, discretion must be used when setting up the DC Brake Level. Motor heating during DC braking is similar to motor heating during starting. Even though the Motor OL is active (if not set to "Off") during DC injection braking, excessive motor heating could still result if the load inertia is large or the brake level is set too high. Caution must be used to assure that the motor has the thermal capacity to handle braking the desired load in the desired period of time without excessive heating.

⌘ NOTE: Consult motor manufacturer for high inertia applications.

⌘ NOTE: Not to be used as an emergency stop. When motor braking is required even during a power outage an Electro mechanical brake must be used.

See Also

Stop Mode (P15 / CFN 14) parameter on page 87.
DC Brake Time (P20 / CFN 19) parameter on page 92.
DC Brake Delay (P21 / CFN 20) parameter on page 93.
Controlled Fault Stop Enable (P43 / PFN 12) parameter on page 105.
Digital Input (P48-50 / I/O 01-03) parameters on page 110.
Theory of Operation section 7.1, Solid State Motor Overload Protection, on page 132.
Theory of Operation section 7.5.9, DC Injection Braking Control, on page 156.

6 - PARAMETER DESCRIPTION

P20

DC Brake Time

CFN 19

LED Display



LCD Display

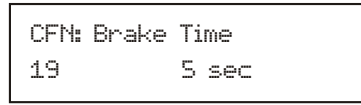

Range

1 – 180 Seconds (**Default 5**)

Description

When the Stop Mode (P15 / CFN 14) is set to "DC brake", the DC Brake Time parameter sets the time that DC current is applied to the motor. The required brake time is determined by the combination of the system inertia, system friction, and the desired braking level. Increase the brake time if the motor is still rotating when the braking finishes to minimize unnecessary motor heating.

See Also

Motor Running Overload Class (P3 / QST 03) parameter on page 76.
Stop Mode (P15 / CFN 14) parameter on page 87.
DC Brake Level (P19 / CFN 18) parameter on page 91.
DC Brake Delay (P21 / CFN 20) parameter on page 93.
Controlled Fault Stop Enable (P43 / PFN 12) parameter on page 105.
Theory of Operation section 7.5.9, DC Injection Braking Control, on page 156.

6 - PARAMETER DESCRIPTION

P21	DC Brake Delay	CFN 20
------------	-----------------------	---------------

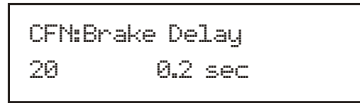
LED Display**LCD Display**

Range 0.1 – 3.0 Seconds (**Default 0.2**)

Description When the Stop Mode (P15, CFN 14) is set to "DC brake", the DC Brake Delay time is the time delay between when a stop is commanded and the DC braking current is applied to the motor. This delay allows the residual magnetic field and motor counter EMF to decay before applying the DC braking current. If a large surge of current is detected when DC braking is first engaged increase the delay time. If the delay before the braking action begins is too long then decrease the delay time. In general, low horsepower motors can utilize shorter delays while large horsepower motor may require longer delays.

See Also Stop Mode (P15 / CFN 14) parameter on page 87.
DC Brake Level (P19 / CFN 18) parameter on page 91.
DC Brake Time (P20 / CFN 19) parameter on page 92.
Theory of Operation section 7.5.9, DC Injection Braking Control, on page 156.

P22	Initial Motor Current 2	CFN 06
------------	--------------------------------	---------------

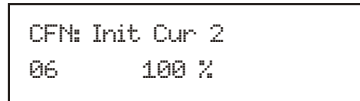
LED Display**LCD Display**

Range 50 – 600 % of FLA (**Default 100%**)

Description The Initial Current 2 parameter is set as a percentage of the Motor FLA (P1 / QST 01) parameter setting when the second ramp is active. Refer to the Initial Current 1 (P6 / CFN 03) parameter on page 79 for description of operation.

See Also Initial Current 1 (P6 / QST 06) parameter on page 79.
Digital Input Configuration (P48-50 / I/O 01-03) parameters on page 110 .
Theory of Operation section 7.3.1, Current Ramp Settings, Ramps and Times on page 140.
Theory of Operation section 7.3.6, Dual Acceleration Ramp Control on page 147.

P23	Maximum Motor Current 2	CFN 07
------------	--------------------------------	---------------

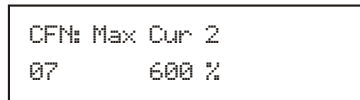
LED Display**LCD Display**

Range 100 – 800 % of FLA (**Default 600%**)

Description The Maximum Current 2 parameter is set as a percentage of the Motor FLA (P1 / QST 01) parameter setting, when the second ramp is active. Refer to the Maximum Current 1 (P7 / CFN 04) parameter on page 80 for description of operation.

See Also Maximum Current 1 (P7 / QST 07) parameter on page 80.
Digital Input Configuration (P48 / I/O 01-03) parameters on page 110.
Theory of Operation section 7.3.1, Current Ramp Settings, Ramps and Times on page 140.
Theory of Operation section 7.3.6, Dual Acceleration Ramp Control, on page 147.

6 - PARAMETER DESCRIPTION

P24

Ramp Time 2

CFN 05

LED Display

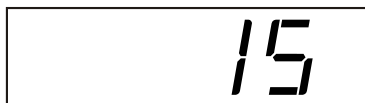
The LED display shows the number 15 in a large, bold, black font.

LCD Display

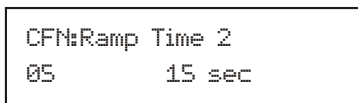
The LCD display shows the text "CFN: Ramp Time 2" on the first line, "05" on the second line, and "15 sec" on the third line.

Range

0 – 300 seconds (**Default 15**)

Description

The Ramp Time 2 parameter sets the time it takes for the starter to allow the current to go from the initial current to the maximum current when the second ramp is active. Refer to the Ramp Time 1 (P8 / CFN 02) parameter on page 83 for description of operation.

See Also

Ramp Time 1 (P8 / QST 08) parameter on page 83.
Digital Input Configuration (P48-P50 / I/O 01-03) parameters on page 110.
Theory of Operation section 7.3.1, Current Ramp Settings, Ramp and Times on page 140.
Theory of Operation section 7.3.6, Dual Acceleration Ramp Control, on page 147.

P25

Kick Level 2

CFN 12

LED Display

The LED display shows the text "OFF" in a large, bold, black font.

LCD Display

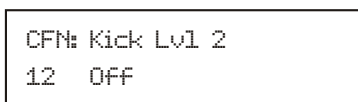
The LCD display shows the text "CFN: Kick Lvl 2" on the first line, "12" on the second line, and "OFF" on the third line.

Range

Off, 100 – 800% of FLA (**Default Off**)

Description

The Kick Level 2 parameter sets the current level that precedes any ramp when a start is first commanded when the second ramp is active. Refer to the Kick Level 1 (P13 / CFN 10) parameter on page 88 for description of operation.

See Also

Kick Level 1 (P13 / CFN 10) parameter on page 88.
Digital Input Configuration (P48-50 / I/O 01-03) parameters on page 110.
Theory of Operation section 7.3.2, Programming A Kick Current on page 141.
Theory of Operation section 7.3.6, Dual Acceleration Ramp Control on page 147.

P26

Kick Time 2

CFN 13

LED Display

The LED display shows the number 1.0 in a large, bold, black font.

LCD Display

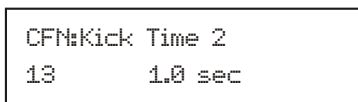
The LCD display shows the text "CFN: Kick Time 2" on the first line, "13" on the second line, and "1.0 sec" on the third line.

Range

0.1 – 10.0 seconds (**Default 1.0**)

Description

The Kick Time 2 parameter sets the length of time that the kick current level is applied to the motor when the second ramp is active. Refer to the Kick Time 1 (P14 / CFN 11) parameter on page 88 for description of operation.

6 - PARAMETER DESCRIPTION

P27	Preset Slow Speed	CFN 21
-----	--------------------------	--------

LED Display



LCD Display

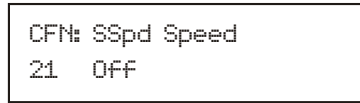

Range

Off, 7.1%, 14.3 % **(Default Off)**

Description

The Preset Slow Speed parameter sets the speed of motor operation. When set to "Off", slow speed operation is disabled.

Slow speed operation is commanded by programming one of the digital inputs to either "Slow Speed Forward" or "Slow Speed Reverse". Energizing the Slow Speed Input when the starter is in idle will initiate slow speed operation.

⚠ **NOTE:** When the motor is operating at slow speeds its cooling capacity can be greatly reduced. Therefore, the running time of the motor at a given current level is dependant on the motor's thermal capacity. Although the Motor OL is active (if not set to "Off") during slow speed operation, it is recommended that the motor temperature be monitored when slow speed is used for long periods of time.

See Also

Slow Speed Current Level (P27 / CFN 22) parameter on page 95.
Slow Speed Time Limit (P29 / CFN 23) parameter on page 96.
Digital Input Configuration (P48-P50 / I/O 01-03) parameters on page 110.
Relay Output Configuration (P52-54 / I/O 05-07) parameters on page 112.
Theory of Operation section 7.6.2, Slow Speed Operation on page 157.

⚠ **NOTE:** Remote Source (P5 / QST 05) must be set to 'Terminal'.

⚠ **NOTE:** For Continuous Slow Speed Operation, an RC2 is required.

P28	Preset Slow Speed Current Level	CFN 22
-----	--	--------

LED Display



LCD Display

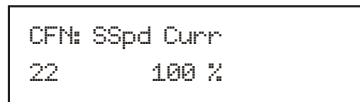

Range

10 – 400 % FLA **(Default 100%)**

Description

The Preset Slow Speed Current Level parameter selects the level of current applied to the motor during slow speed operation. The parameter is set as a percentage of motor full load amps (FLA). This value should be set to the lowest possible current level that will properly operate the motor.

See Also

Motor Running Overload Class (P3 / QST 03) parameter on page 76.
Slow Speed Time Limit (P29 / CFN 23) parameter on page 96.
Theory of Operation section 7.6.2, Slow Speed Operation on page 157.

6 - PARAMETER DESCRIPTION

P29

Slow Speed Time Limit

CFN 23

LED Display

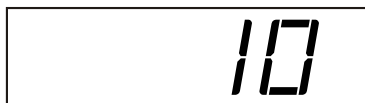

LCD Display

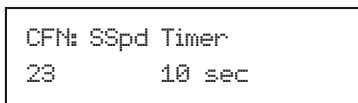

Range

Off, 1 – 900 Seconds (**Default 10**)

Description

The Slow Speed Time Limit parameter sets the amount of time that continuous operation of slow speed may take place. When this parameter is set to "Off", the timer is disabled. This parameter can be used to limit the amount of slow speed operation to protect the motor and/or load.

⌘ **NOTE:** The Slow Speed Time Limit includes the time used for the Slow Speed Kick if kick is enabled.

⌘ **NOTE:** The Slow Speed Time Limit resets when the motor is stopped. Therefore, this timer does not prevent the operator from stopping slow speed operation and re-starting the motor, which can result in the operation time of the motor being exceeded.

⌘ **NOTE:** When the motor is operating at slow speeds, its cooling capacity can be greatly reduced. Therefore, the running time of the motor at a given current level is dependant on the motor's thermal capacity. Although the Motor OL is active (if not set to "Off") during slow speed operation it is recommended that the motor temperature be monitored if slow speed is used for long periods of time.

See Also

Motor Running Overload Class (P3 / QST 03) parameter on page 76.
Slow Speed Current Level (P28 / CFN 22) parameter on page 95.
Theory of Operation section 7.6.2, Slow Speed Operation on page 157.

P30

Slow Speed Kick Level

CFN 24

LED Display



LCD Display

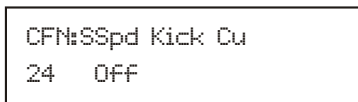

Range

Off, 100 – 800 % FLA (**Default Off**)

Description

The Slow Speed Kick Level sets the short-term current level that is applied to the motor to accelerate the motor for slow speed operation. If set to "Off" the Slow Speed Kick feature is disabled. Slow speed kick can be used to "break loose" difficult to start loads while keeping the normal slow speed current level at a lower level.

This parameter should be set to a midrange value and then the Slow Speed Kick Time should be increased in 0.1 second intervals until the kick is applied long enough to start the motor rotating. If the motor does not start rotating then increase the Slow Speed Kick Level and begin adjusting the kick time from 1.0 seconds again.

If the motor initially accelerates too fast then reduce the Slow Speed Kick Level and/or reduce the Slow Speed Kick Time.

See Also

Kick Level 1 (P13 / CFN 10) parameter on page 86.
Slow Speed Kick Time (P31 / CFN 25) parameter on page 97.
Theory of Operations section 7.6.2, Slow Speed Operation on page 157.

6 - PARAMETER DESCRIPTION

P31

Slow Speed Kick Time

CFN 25

LED Display



LCD Display



Range

0.1 – 10.0 seconds (**Default 1.0**)

Description

The Slow Speed Kick Time parameter sets the length of time that the Slow Speed Kick current level (P30, CFN 24) is applied to the motor at the beginning of slow speed operation. After the Slow Speed Kick Level is set, the Slow Speed Kick Time should be adjusted so that the motor starts rotating when a slow speed command is given.

If the motor initially accelerates too fast then reduce the Slow Speed Kick Level (P30 / CFN 24) and/or reduce the Slow Speed Kick Time.

See Also

Slow Speed Kick Level (P30 / CFN 24) parameter on page 96.
Theory of Operations section 7.6.2, Slow Speed Operation on page 157.

6 - PARAMETER DESCRIPTION

Jump to Parameter	PFN 00
--------------------------	---------------

By changing the value of this parameter and pressing [ENTER], you can jump directly to any parameter within that group.

P32	Over Current Trip Level	PFN 01
------------	--------------------------------	---------------

LED Display



LCD Display

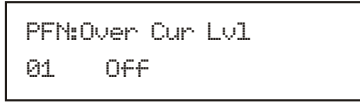

Range

Off, 50 – 800 % of FLA (**Default Off**)

Description

If the MX² detects a one cycle, average current that is greater than the level defined, an over current alarm condition exists and any relays programmed as alarm will energize. The over current timer starts a delay time. If the over current still exists when the delay timer expires, the starter Over Current Trips (F31) and any relay programmed as fault relay changes state.

The Over Current Trip is only active in the UTS state, Energy Saver state, Current follower or while in the Phase Control mode.

A relay can be programmed to change state when an over current alarm condition is detected.

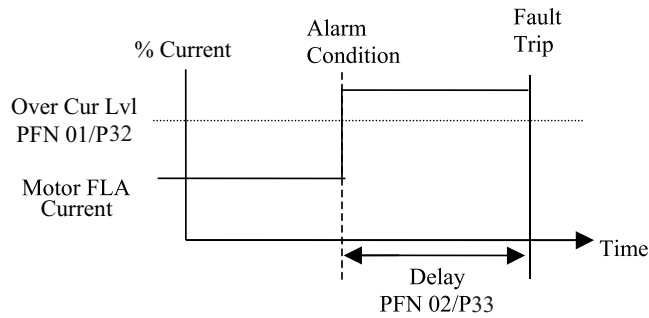

See Also

- Over Current Time (P33 / PFN 02) parameter on page 99.
- Auto Reset Limit (P42 / PFN 11) parameter on page 104.
- Controlled Fault Stop Enable (P43 / PFN 12) parameter on page 105.
- Relay Output Configuration (P52-P54 / I/O 05-07) parameters on page 112.

6 - PARAMETER DESCRIPTION

P33

Over Current Trip Delay Time

PFN 02

LED Display



LCD Display

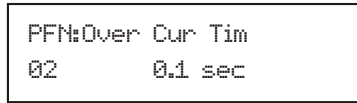

Range

Off, 0.1 – 90.0 seconds (**Default 0.1**)

Description

The Over Current Trip Delay Time parameter sets the period of time that the motor current must be greater than the Over Current Level (P32 / PFN 01) parameter before an over current fault and trip occurs.

If "Off" is selected, the over current timer does not operate and the starter does not trip. It energizes any relay set to Over current until the current drops or the starter trips on an overload.

A shear pin function can be implemented by setting the delay to its minimum value.

See Also

Over Current Level (P32 / PFN 01) parameter on page 98.

Auto Reset Limit (P42 / PFN 11) parameter on page 104.

Controlled Fault Stop Enable (P43 / PFN 12) parameter on page 105.

Relay Output Configuration (P52-54 / I/O 05-07) parameters on page 112.

6 - PARAMETER DESCRIPTION

P34

Under Current Trip Level

PFN 03

LED Display

OFF

LCD Display

PFN:Undr Cur Lvl
03 OFF

Range

Off, 5 – 100 % of FLA (**Default Off**)

Description

If the MX² detects a one cycle, average current that is less than the level defined, an under current alarm condition exists and any relays programmed as alarm will energize. The under current timer starts a delay time. If the under current still exists when the delay time expires, the starter Under Current Trips (F34) and any relay programmed as fault relay changes state.

The Under Current Trip Level is only active in the UTS state, Energy Saver state, Current follower or while in the Phase Control mode.

A relay can be programmed to change state when an under current alarm condition is detected.

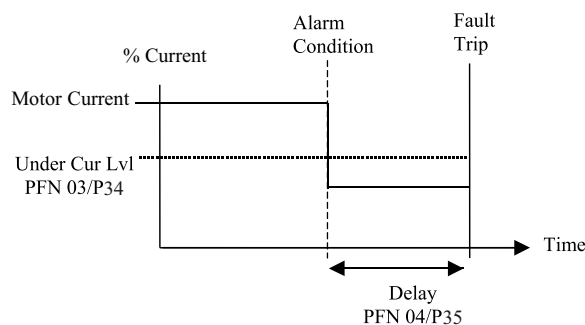

See Also

Under Current Time (P35 / PFN 04) parameter on page 100.
Auto Reset Limit (P42 / PFN 11) parameter on page 104.
Controlled Fault Stop Enable (P43 / PFN 12) parameter on page 105.
Relay Output Configuration (P52-54 / I/O 05-07) parameters on page 112.

P35

Under Current Trip Delay Time

PFN 04

LED Display

0.1

LCD Display

PFN:Undr Cur Tim
04 0.1 sec

Range

Off, 0.1 – 90.0 seconds (**Default 0.1**)

Description

The Under Current Trip Delay Time parameter sets the period of time that the motor current must be less than the Under Current Trip Level (P34 / PFN 03) parameter before an under current fault and trip occurs.

If "Off" is selected, the under current timer does not operate and the starter does not trip. It energizes any relay set to Undercurrent until the current rises.

See Also

Under Current Trip Level (P34 / PFN 03) parameter on page 100.
Auto Reset Limit (P42 / PFN 11) parameter on page 104.
Controlled Fault Stop Enable (P43 / PFN 12) parameter on page 105.
Relay Output Configuration (P52-54 / I/O 05-07) parameters on page 112.

6 - PARAMETER DESCRIPTION

P36	Current Imbalance Trip Level	PFN 05
------------	-------------------------------------	---------------

LED Display



LCD Display

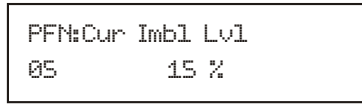

Range

Off, 5 – 40 % (**Default 15%**)

Description

The Current Imbalance Trip Level parameter sets the imbalance that is allowed before the starter shuts down. The current imbalance must exist for 10 seconds before a fault occurs.

Current is less than the FLA setting

The equation for the current imbalance is:

$$\%imbalance = \frac{(I_{ave} - I_{max})}{FLA} \times 100\%$$

I_{ave} = average current

I_{max} = greatest of: |L1- I_{ave} | or |L2- I_{ave} | or |L3- I_{ave} |

FLA = value programmed into P1

Current is greater than the FLA setting

The equation for the current imbalance is:

$$\%imbalance = \frac{(I_{ave} - I_{max})}{I_{ave}} \times 100\%$$

I_{ave} = average current

I_{max} = greatest of: |L1- I_{ave} | or |L2- I_{ave} | or |L3- I_{ave} |

FLA = value programmed into P1

If the highest calculated current imbalance is greater than the current imbalance level for 10 seconds, the starter shuts down the motor and declares a Fault 37 (Current Imbalance).

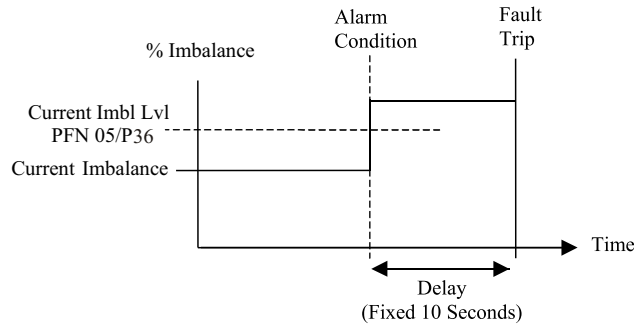

See Also

Auto Reset Limit (P42 / PFN 11) parameter on page 104.

Controlled Fault Stop Enable (P43 / PFN 12) parameter on page 105.

6 - PARAMETER DESCRIPTION

P37

Residual Ground Fault Trip Level

PFN 06

LED Display



LCD Display

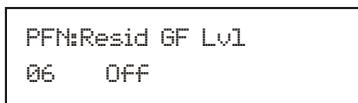

Range

Off, 5 – 100 % FLA **(Default Off)**

Description

The Residual Ground Fault Trip Level parameter sets a ground fault current trip or indicate level that can be used to protect the system from a ground fault condition. The starter monitors the instantaneous sum of the three line currents to detect the ground fault current.

The ground fault current has to remain above the ground fault level for 3 seconds before the starter recognizes a ground fault condition. Once the starter recognizes a ground fault condition, it shuts down the motor and declares a Fault 38 (Ground Fault).

If a programmable relay is set to ground fault (GND), the starter energizes the relay when the condition exists.

A typical value for the ground fault current setting is 10% to 20% of the full load amps of the motor.

⚠ **NOTE:** This is often referred to as residual ground fault protection. This type of protection is meant to provide machine ground fault protection only. It is not meant to provide human ground fault protection.

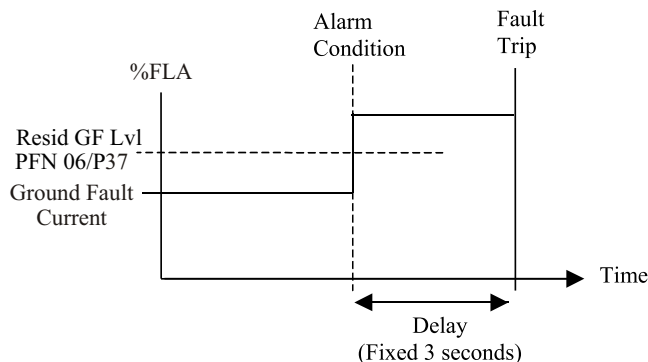

⚠ **NOTE:** The MX² residual ground fault protection function is meant to detect ground faults on solidly grounded systems. Use on a high impedance or floating ground power system may impair the usefulness of the MX² residual ground fault detection feature.

⚠ **NOTE:** Due to uneven CT saturation effects and motor and power system variations, there may be small values of residual ground fault currents measured by the MX² during normal operation.

See Also

Auto Reset Limit (P42 / PFN 11) parameter on page 104.

Controlled Fault Stop Enable (P43 / PFN 12) parameter on page 105.

Relay Output Configuration (P52-54 / I/O 05-07) parameters on page 112.

6 - PARAMETER DESCRIPTION

P38

Over Voltage Trip Level

PFN 07

LED Display



LCD Display

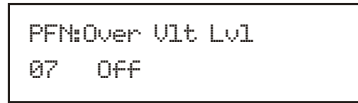

Range

Off, 1 – 40 % **(Default Off)**

Description

If the MX² detects a one cycle input phase voltage that is above the Over Voltage Trip Level, the over/under voltage alarm is shown and the voltage trip timer begins counting. The delay time must expire before the starter faults. The over voltage condition and the phase is displayed.

⚠ **NOTE:** For the over voltage protection to operate correctly, the rated voltage parameter (P76 / FUN05) must be set correctly.

⚠ **NOTE:** The voltage level is only checked when the starter is running.

See Also

Under Voltage Level (P39 / PFN 08) parameter on page 103.
Voltage Trip Time (P40 / PFN 09) parameter on page 104.
Auto Reset Limit (P42 / PFN 11) parameter on page 104.
Controlled Fault Stop Enable (P43 / PFN 12) parameter on page 105.
Rated Voltage (P76 / FUN 05) parameter on page 125.

P39

Under Voltage Trip Level

PFN 08

LED Display



LCD Display

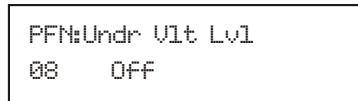

Range

Off, 1 – 40 % **(Default Off)**

Description

If the MX² detects a one cycle input phase voltage that is below the Under Voltage Trip Level, the over/under voltage alarm is shown and the voltage trip timer begins counting. The delay time must expire before the starter faults. The under voltage condition and the phase is displayed.

⚠ **NOTE:** For the under voltage protection to operate correctly, the Rated Voltage parameter (P76 / FUN05) must be set correctly.

⚠ **NOTE:** The voltage level is only checked when the starter is running.

See Also

Over Voltage Level (P38 / PFN 07) parameter on page 103.
Voltage Trip Time (P40 / PFN 09) parameter on page 104.
Auto Reset Limit (P42 / PFN 11) parameter on page 104.
Controlled Fault Stop Enable (P43 / PFN 12) parameter on page 105.
Rated Voltage (P76 / FUN 05) parameter on page 125.

6 - PARAMETER DESCRIPTION

P40

Over/Under Voltage Trip Delay Time

PFN 09

LED Display



LCD Display

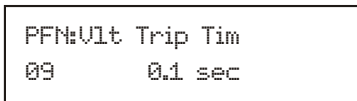

Range 0.1 – 90.0 seconds (**Default 0.1**)

Description The Voltage Trip Delay Time parameter sets the period of time that either an over voltage (P38 / PFN 07) or under voltage (P39 / PFN 08) condition must exist before a fault occurs.

See Also Over Voltage Level (P38 / PFN 07) parameter on page 103.
Under Voltage Level (P39 / PFN 08) parameter on page 103.
Auto Reset Limit (P42 / PFN 11) parameter on page 104.
Controlled Fault Stop Enable (P43 / PFN 12) parameter on page 105.

P41

Auto Fault Reset Time

PFN 10

LED Display



LCD Display

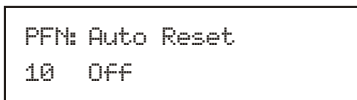

Range Off, 1 – 900 seconds (**Default Off**)

Description The Auto Fault Reset Time parameter sets the time delay before the starter will automatically reset a fault. For the list of faults that may be auto reset, refer to Appendix B - Fault Codes on page 196.

⚠ **NOTE:** A start command needs to be initiated once the timer resets the fault.

See Also Auto Reset Limit (P42 / PFN 11) parameter on page 104.
Appendix B - Fault Codes on page 196.

P42

Auto Fault Reset Count Limit

PFN 11

LED Display



LCD Display

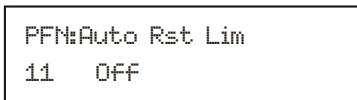

Range Off, 1 – 10 (**Default Off**)

Description The Auto Fault Reset Count Limit parameter sets the number of times that an auto reset may occur. Once the Auto Reset Limit is reached, faults will no longer be automatically reset.

See Also Auto Fault Reset Time (P41 / PFN 10) parameter on page 104.

⚠ **NOTE:** If the maximum reset count has been reached and the starter has locked out, only a user reset will clear the reset counts.

⚠ **NOTE:** If a few auto resets have been performed but the count has not reached the limit, the number of accumulated resets will be cleared after 15 minutes if another fault does not occur.

⚠ **NOTE:** The count can be always cleared by power cycling the starter.

6 - PARAMETER DESCRIPTION

P43

Controlled Fault Stop Enable

PFN 12

LED Display



LCD Display

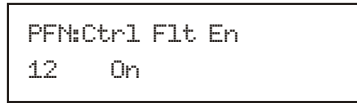

Range

Off – On (**Default On**)

Description

A Controlled Fault Stop Enable can occur if this parameter is "On". The controlled stop will occur before the starter trips. During a controlled fault stop, the action selected by the Stop Mode parameter is performed before the starter is tripped. This prevents the occurrence of water hammer etc. in sensitive systems when a less than fatal fault occurs.

⚠ **NOTE:** All relays except the UTS relay are held in their present state until the stop mode action has been completed.

⚠ **NOTE:** Only certain faults can initiate a controlled fault stop. Some faults are considered too critical and cause the starter to stop immediately regardless of the Controlled Fault Stop Enable parameter.

Refer to Appendix B - Fault Codes to determine if a fault may perform a controlled stop.

See Also

Stop Mode (P15 / CFN 14) parameter on page 87.
Appendix B - Fault Codes on page 196.

6 - PARAMETER DESCRIPTION

P44

Independent Starting/Running Overload

PFN 13

LED Display

The LED display shows the word "OFF" in a large, stylized, seven-segment font.

LCD Display

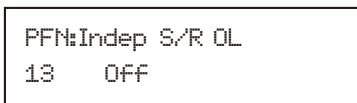
The LCD display shows the text "PFN:Indep S/R OL" on the first line and "13 Off" on the second line.

Range

Off – On (**Default Off**)

Description

If “Off”

When this parameter is “Off” the overload defined by the Motor Running Overload Class (P3 / QST 03/PFN 15) parameter is active in all states.

If “On”

When this parameter is “On”, the starting and running overloads are separate with each having their own settings. The starting overload class (P45 / PFN 14) is used during motor acceleration and acceleration kick. The running overload class is used during all other modes of operation.

If both the running overload and the starting overload classes are set to "Off", then the existing accumulated motor OL% is erased and no motor overload is calculated in any state.

If the starting overload class is set to "Off" and the running overload class is set to "On", then the I^2t motor overload does NOT accumulate during acceleration kick and acceleration ramping states. However, the existing accumulated OL% remains during starting and the hot/cold motor compensation is still active. The OL% is capped at 99% during starting.

Although there is really no reason to do so, the starting overload class could be set to "On" and the running overload class set to "Off".

See Also

Motor Running Overload Class (P3 / QST 03) parameter on page 76.

Motor Starting Overload Class (P45 / PFN 14) parameter on page 107.

Motor Overload Hot/Cold Ratio (P46 / PFN 16) parameter on page 108.

Motor Overload Cooling Time (P47 / PFN 17) parameter on page 109.

Theory of Operation section 7.1.7, Separate Starting and Running Motor Overload Settings on page 136.

6 - PARAMETER DESCRIPTION

P45

Motor Overload Class Starting

PFN 14

LED Display



LCD Display

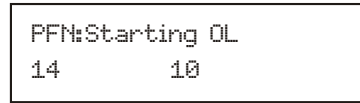

Range

Off, 1 – 40 (**Default class 10**)

Description

The Motor Overload Class Starting parameter sets the class of the electronic overload when starting. The starter stores the thermal overload value as a percentage value between 0 and 100%, with 0% representing a “cold” overload and 100% representing a tripped overload.

The starting overload class is active during Kicking and Ramping when the Independent Starting/Running Overload (P44 / PFN 13) parameter is set to “On”.

When the Motor Starting Overload Class parameter is set to "Off", the electronic overload is disabled while starting the motor.

⚠ **NOTE:** Care must be taken not to damage the motor when turning the starting overload class off or setting to a high value.

⚠ **NOTE:** Consult motor manufacturer data to determine the correct motor OL settings.

See Also

Motor Running Overload Class (P3 / QST 03) parameter on page 76.

Independent Starting/Running Overload (P44 / PFN 13) parameter on page 106.

Motor Overload Hot/Cold Ratio (P46 / PFN 16) parameter on page 108.

Motor Overload Cooling Time (P47 / PFN 17) parameter on page 109.

Relay Output Configuration (P52-P54 / I/O 05-07) parameters on page 112.

Theory of Operation section 7.1, Solid State Motor Overload Protection on page 132.

Motor Overload Class Running

PFN 15

See Quickstart group QST 03 - Motor Overload Class Running on page 76 for details.

6 - PARAMETER DESCRIPTION

P46

Motor Overload Hot/Cold Ratio

PFN 16

LED Display



LCD Display

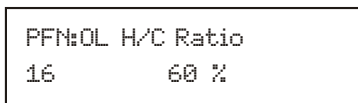

Range

0 – 99% (Default 60%)

Description

The Motor Overload Hot/Cold Ratio parameter defines the steady state overload content (OL_{ss}) that is reached when the motor is running with a current less than full load current (FLA) * Service Factor (SF). This provides for accurate motor overload protection during a “warm” start.

The steady state overload content is calculated by the following formula.
The rise or fall time for the overload to reach this steady state is defined by the Motor Overload Cooling Time parameter.

$$OL_{ss} = OL \text{ H/C Ratio} \frac{\text{Current}}{\text{FLA}} \frac{1}{\text{Current Imbalance Derate Factor}}$$

The default value of 60% for Motor Overload Hot/Cold Ratio parameter is typical for most motors. A more accurate value can be derived from the hot and cold locked rotor times that are available from most motor manufacturers using the following formula.

$$OL \text{ H/C Ratio} = 1 \frac{\text{Max Hot Locked Rotor Time}}{\text{Max Cold Locked Rotor Time}} \times 100\%$$

⌘ **NOTE:** Consult motor manufacturer data to determine the correct motor overload settings.

⌘ **NOTE:** During a warm start the starter would be Class 10, and if it's a cold start, the starter would be a class 25.

See Also

Motor Running Overload Class (P3 / QST 03) parameter on page 76.
Independent Starting/Running Overload (P44 / PFN 13) parameter on page 106.
Motor Starting Overload Class (P45 / PFN 14) parameter on page 107.
Motor Overload Cooling Time (P47 / PFN 17) parameter on page 109.
Relay Output Configuration (P52-54 / I/O 05-07) parameters on page 112.
Theory of Operation section 7.1.6, Hot/Cold Motor Overload Compensation on page 135.
Theory of Operation section 7.1.4, Current Imbalance/Negative Sequence Current Compensation on page 134.

6 - PARAMETER DESCRIPTION

P47

Motor Overload Cooling Time

PFN 17

LED Display



LCD Display

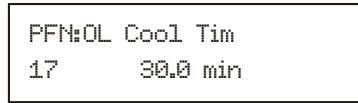

Range

1.0 – 999.9 minutes (**Default 30.0**)

Description

The Motor Overload Cooling Time parameter is the time to cool from 100% to less than (<) 1%. When the motor is stopped, the overload content reduces exponentially based on Motor Overload Cooling Time parameter.

Refer to the following equation:

$$\text{OL Content} = \text{OL Content when Stopped} * e^{-\frac{t}{\text{CoolingTime}}}$$

So, a motor with a set cooling time of 30 minutes (1800 sec) with 100% accumulated OL content cools to <1% OL content in 30 minutes.

⚠ **NOTE:** Consult motor manufacturer data to determine the correct motor cooling time.

See Also

Motor Running Overload Class (P3 / QST 03) parameter on page 76.
Independent Starting/Running Overload (P44 / PFN 13) parameter on page 106.
Motor Starting Overload Class (P45 / PFN 14) parameter on page 107.
Motor Overload Hot/Cold Ratio (P46 / PFN 16) parameter on page 108.
Theory of Operation section 7.1.8, Motor Cooling While Stopped on page 137.
Theory of Operation section 7.1.9, Motor Cooling While Running on page 138.

6 - PARAMETER DESCRIPTION

Jump to Parameter

I/O 00

By changing the value of this parameter and pressing [ENTER], you can jump directly to any parameter within that group.

P48,49,50

Digital Input Configuration

I/O 01,02,03

	LED Display	LCD Display
P48	STOP	I/O:DI 1 Config 01 Stop
P49	OFF	I/O:DI 2 Config 02 OFF
P50	OFF	I/O:DI 3 Config 03 OFF

Range

LED	LCD	Description
OFF	Off	Off, Not Assigned, Input has no function. (Default DI 2 & DI 3)
STOP	Stop	Stop Command for 3-wire control. (Default DI 1)
FH	Fault High	Fault High, Fault when input is asserted, 120V applied.
FL	Fault Low	Fault Low, Fault when input is de-asserted, 0V applied.
F _r	Fault Reset	Reset when input asserted, 120V applied.
dSc	Disconnect	Disconnect switch monitor.
hLn	Inline Cnfrm	Inline contactor feedback.
bSP	Bypass Cnfrm	Bypass/2M, bypass contactor feedback, 2M contactor feedback in full voltage or Wye-delta.
EOL _r	E OL Reset	Emergency Motor Overload content reset. After an OL trip has occurred. Reset when input asserted, 120V applied.
L _r	Local/Remote	Local/Remote control source, Selects whether the Local Source parameter or the Remote Source parameter is the control source. Local Source is selected when input is de-asserted, 0V applied. Remote Source selected when input asserted, 120V applied.
hd IS	Heat Disable	Heater disabled when input asserted, 120V applied.
hEn	Heat Enable	Heater enabled when input asserted, 120V applied.
rSEL	Ramp Select	Ramp 2 is enabled when input asserted, 120V applied.
SS F	Slow Spd Fwd	Operate starter in slow speed forward mode.
SS r	Slow Spd Rev	Operate starter in slow speed reverse mode.
bd IS	Brake Disabl	Disable DC injection braking.
bEn	Brake Enabl	Enable DC injection braking.
runE	Run Enable	When High, starter will run. When Low, starter stops.
rund	Run Disable	When High, starter will stop. When Low, starter runs.

Description

I/O parameters 1 - 3 configure which features are performed by the D1 to D3 terminals.

See Also

Local Source (P4 / QST 04) parameter on page 77 .
 Remote Source (P5 / QST 05) parameter on page 78.
 Bypass Feedback Time (P64 / I/O 17) parameter on page 118.
 Heater Level (P73 / FUN 08) parameter on page 123.
 Theory of Operation section 7.1.10, Emergency Motor Overload Reset on page 138.
 Theory of Operation section 7.3.6, Dual Acceleration Ramp Control on page 147.
 Theory of Operation section 7.8, Wye-Delta Operation on page 160.
 Theory of Operation section 7.13, Start/Stop Control with a Hand/Off/Auto Selector Switch on page 168.

6 - PARAMETER DESCRIPTION

P51	Digital Fault Input Trip Time	I/O 04
-----	-------------------------------	--------

LED Display



LCD Display

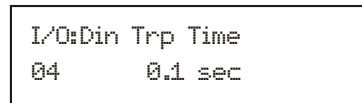

Range

0.1-90.0 Seconds (**Default 0.1 Sec**)

Description:

The Digital Fault Input Trip Time parameter sets the length of time the Digital input must be high or low before a trip occurs. This delay time only functions for fault high and fault low.

See Also

Digital Input Configuration (P48-50 / I/O 01-03) parameters on page 110.

6 - PARAMETER DESCRIPTION

P52, 53, 54

Relay Output Configuration

I/O 05, 06, 07

	LED Display	LCD Display
P52	FLFS	I/O: R1 Config 05 Fault FS
P53	OFF	I/O: R2 Config 06 Off
P54	OFF	I/O: R3 Config 07 Off

Range	LED	LCD	Description
	OFF	Off	Off, Not Assigned. May be controlled over Modbus (Default R2 & R3)
	FLFS	Fault FS	Faulted – Fail Safe operation. Energized when no faults present, de-energized when faulted. (Default R1)
	FLrF	Fault NFS	Faulted– Non Fail Safe operation. Energized when faulted.
	run	Running	Running, starter running, voltage applied to motor.
	utS	UTS	Up to Speed, motor up to speed or transition to for Wye/Delta Operation.
	AL	Alarm	Alarm, any alarm condition present.
	rdYr	Ready	Ready, starter ready for start command.
	LOC	Locked Out	Locked Out.
	OC	Overcurrent	Overcurrent Alarm, overcurrent condition detected.
	UC	Undercurrent	Undercurrent Alarm, undercurrent condition detected.
	OLA	OL Alarm	Overload Alarm.
	ShFS	Shunt FS	Shunt Trip Relay – Fail Safe operation, energized when no shunt trip fault present, de-energized on shunt trip fault.
	ShrF	Shunt NFS	Shunt Trip Relay – Non Fail Safe operation, de-energized when no shunt trip fault present, energized on shunt trip fault.
	9FLt	Ground Fault	A Ground Fault trip has occurred.
	ES	Energy Saver	Operating in Energy Saver Mode.
	HEAt	Heating	Motor Heating, starter applying heating pulses to motor.
	SSPd	Slow Spd	Starter operating in slow speed mode.
	SS F	Slow Spd Fwd	Starter operating in slow speed forward mode.
	SS r	Slow Spd Rev	Starter operating in slow speed reverse mode.
	deb	Braking	Starter is applying DC brake current to motor.
	FFn	Cool Fan Ctl	Heatsink fan control.

Description

I/O parameters 1 - 3 configure which functions are performed by the R1 to R3 relays.

See Also

Up To Speed Time (P9 / QST 09) parameter on page 82.
 Over Current Level (P32 / PFN 01) parameter on page 98.
 Under Current Level (P34 / PFN 03) parameter on page 100.
 Residual Ground Fault Level (P37 / PFN 06) parameter on page 102.
 Inline Configuration (P63 / I/O 16) parameter on page 118.
 Heater Level (P73 / FUN 08) parameter on page 123.
 Energy Saver (P72 / FUN 09) parameter on page 122.
 Theory of Operation section 7.1.3, Motor Overload Operation on page 134.
 Theory of Operation section 7.8, Wye-Delta Operation on page 160.
 Theory of Operation section 7.9, Across The Line (Full Voltage Starter) on page 163.
 Appendix B - Fault Codes on page 196.

6 - PARAMETER DESCRIPTION

P55	Analog Input Trip Type	I/O 08
------------	-------------------------------	---------------

LED Display



LCD Display

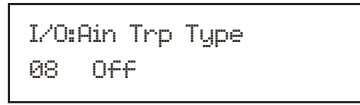

Range

LED	LCD	Description
OFF	Off	Off, Disabled. (Default)
L0	Low Level	Low, Fault if input signal below preset trip level.
H1	High Level	High, Fault if input signal above preset trip level.

Description

The analog input is the reference input for a starter configured as a Phase Controller or Current Follower. In addition, the Analog Input Trip Type parameter allows the user to set a "high" or "low" comparator based on the analog input. If the type is set to "Low", then a fault occurs if the analog input level is below the trip level for longer than the trip delay time. If the type is set to "High", then a fault occurs if the analog input level is above the trip level for longer than the trip delay time. This function is only active when the motor is running.

This feature can be used in conjunction with using the analog input as a reference for a control mode in order to detect an open 4-20mA loop providing the reference. Set the Analog Input Trip Type parameter to "Low" and set the Analog Input Trip Level (P56 / I/O 09) parameter to a value less than (<) 20%.

⚠ **NOTE:** The DIP switch (SW1) on the card changes the analog input and analog output between 0-10V or 0-20mA. See Figure 18 to see DIP Switch Settings. ANALOG INPUT SW1-1 ANALOG OUTPUT SW1-2.

See Also

- Analog Input Trip Level (P56 / I/O 09) parameter on page 114.
- Analog Input Trip Time (P57 / I/O 10) parameter on page 114.
- Analog Input Span (P58 / I/O 11) parameter on page 115.
- Analog Input Offset (P59 / I/O 12) parameter on page 116.
- Starter Type (P74 / FUN 07) parameter on page 124.
- Theory of Operation section 7.11, Phase Control on page 165.
- Theory of Operation section 7.12, Current Follower on page 167.

6 - PARAMETER DESCRIPTION

P56

Analog Input Trip Level

I/O 09

LED Display

The LED display shows the number 50 in a large, bold, digital font.

LCD Display

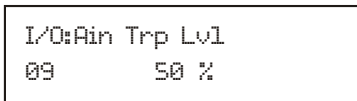
The LCD display shows the text "I/O: Ain Trp Lvl" on the first line, "09" on the second line, and "50 %" on the third line.

Range 0 – 100% (Default 50%)

Description

The Analog Input Trip Level parameter sets the analog input trip or fault level.

This feature can be used to detect an open 4-20mA loop by setting the parameter to "Low" and setting the parameter to a value less than (<) 20%.

⚠ **NOTE:** The analog input trip level is NOT affected by the Analog Input Offset or Analog Input Span parameter settings. Therefore, if the trip level is set to 10% and the Analog Input Trip Type (P55 / I/O 08) parameter is set to "Low", a fault occurs when the analog input signal level is less than (<) 1V or 2mA regardless of what the Analog Input and Analog Input Span parameters values are set to.

⚠ **NOTE:** The DIP switch (SW1) on the card changes the analog input and analog output between 0-10V or 0-20mA. See Figure 18 to see DIP Switch Settings. ANALOG INPUT SW1-1 ANALOG OUTPUT SW1-2.

See Also

Analog Input Trip Type (P55 / I/O 08) parameter on page 113.
Analog Input Trip Level (P56 / I/O 09) parameter on page 114.
Analog Input Span (P58 / I/O 11) parameter on page 115.
Analog Input Offset (P59 / I/O 12) parameter on page 116.

P57

Analog Input Trip Delay Time

I/O 10

LED Display

The LED display shows the number 0.1 in a large, bold, digital font.

LCD Display

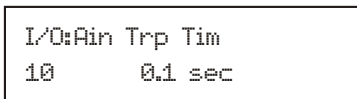
The LCD display shows the text "I/O: Ain Trp Tim" on the first line, "10" on the second line, and "0.1 sec" on the third line.

Range 0.1 – 90.0 seconds (Default 0.1)

Description

The Analog Input Trip Delay Time parameter sets the length of time the analog input trip level (P56 / I/O 09) must be exceeded before a trip occurs.

⚠ **NOTE:** The DIP switch (SW1) on the card changes the analog input and analog output between 0-10V or 0-20mA. See Figure 18 to see DIP Switch Settings. ANALOG INPUT SW1-1 ANALOG OUTPUT SW1-2.

See Also

Analog Input Trip Type (P55 / I/O 08) parameter on page 113.
Analog Input Trip Level (P56 / I/O 09) parameter on page 114.
Analog Input Span (P58 / I/O 11) parameter on page 115.
Analog Input Offset (P59 / I/O 12) parameter on page 116.

6 - PARAMETER DESCRIPTION

P58	Analog Input Span	I/O 11
------------	--------------------------	---------------

LED Display



LCD Display

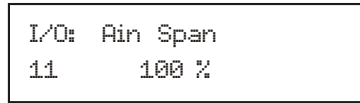

Range

1 – 100% (**Default 100%**)

Description

The analog input can be scaled using the Analog Input Span parameter.

Examples:

For a 0-10V input or 0-20mA input, a 100% Analog Input Span setting results in a 0% input reading with a 0V input and a 100% input reading with a 10V input.

For a 0-5V input, a 50% Analog Input Span setting results in a 0% input reading with a 0V input and a 100% input reading with a 5V input.

For a 4-20mA input, a 80% Analog Input Span setting and a 20% Analog Input Offset setting results in a 0% input reading at 4mA and a 100% input reading at 20mA.

⌘ **NOTE:** The DIP switch (SW1) on the card changes the analog input and analog output between 0-10V or 0-20mA. See Figure 18 to see DIP Switch Settings. ANALOG INPUT SW1-1 ANALOG OUTPUT SW1-2.

⌘ **NOTE:** Input signal readings are clamped at a 100% maximum.

Example: 4ma = 0% input, 20ma = 100% input

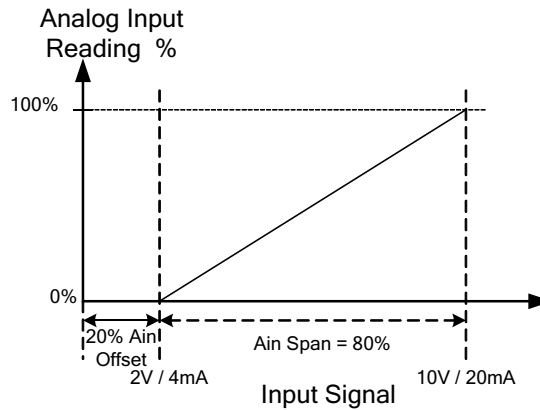

See Also

Analog Input Trip Level (P56 / I/O 09) parameter on page 114.
 Analog Input Trip Time (P57 / I/O 10) parameter on page 114.
 Analog Input Offset (P59 / I/O 12) parameter on page 116.
 Starter Type (P74 / FUN 07) parameter on page 124.
 Theory of Operation section 7.11, Phase Control on page 165.
 Theory of Operation section 7.12, Current Follower on page 167.

6 - PARAMETER DESCRIPTION

P59

Analog Input Offset

I/O 12

LED Display

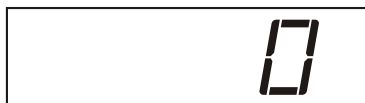

LCD Display

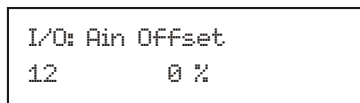

Range 0 – 99% (Default 0%)

Description The analog input can be offset so that a 0% reading can occur when a non-zero input signal is being applied.

Example: Input level of 2V (4mA) => 0% input. In this case the Analog Input Offset parameter should be set to 20% so that the 2v (4mA) input signal results in a 0% input reading.

⌘ **NOTE:** The DIP switch (SW1) on the card changes the analog input and analog output between 0-10V or 0-20mA. See Figure 18 to see DIP Switch Settings. ANALOG INPUT SW1-1 ANALOG OUTPUT SW1-2.

⌘ **NOTE:** For a 4-20mA input, set the Analog Input Span to 80% and the Analog Input Offset to 20%.

⌘ **NOTE:** The measured input reading is clamped at 0% minimum.

See Also

Analog Input Trip Level (P56 / I/O 09) parameter on page 114.
 Analog Input Trip Time (P57 / I/O 10) parameter on page 114.
 Analog Input Span (P58 / I/O 11) parameter on page 115.
 Starter Type (P74 / FUN 07) parameter on page 124.
 Theory of Operation section 7.11, Phase Control on page 165.
 Theory of Operation section 7.12, Current Follower on page 167.

P60

Analog Output Function

I/O 13

LED Display

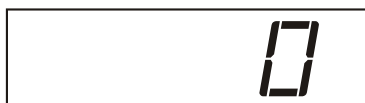

LCD Display

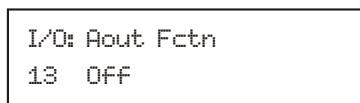

Range	LED	LCD	Description
	0	Off	Off, Disabled (Default)
	1	0 – 100% Curr	Based on per cycle RMS values
	2	0 – 200% Curr	Based on per cycle RMS values
	3	0 – 800% Curr	Based on per cycle RMS values
	4	0 – 150% Volt	Based on per cycle RMS values
	5	0 – 150% OL	Motor Thermal Overload
	6	0 – 10 kW	Based on filtered V and I values
	7	0 – 100 kW	Based on filtered V and I values
	8	0 – 1 MW	Based on filtered V and I values
	9	0 – 10 MW	Based on filtered V and I values
	10	0 – 100% Ain	The output value takes into account the inputs span and offset settings
	11	0 – 100% Firing	Output Voltage to Motor, based on SCR firing angle
	12	Calibration	Calibration, full (100%) output

Description The Analog Output Function parameter selects the function of the analog output. The available analog output function selections and output scaling are shown below. The analog output is updated every 25msec.

⌘ **NOTE:** The DIP switch (SW1) on the card changes the analog input and analog output between 0-10V or 0-20mA. See Figure 18 to see DIP Switch Settings. ANALOG INPUT SW1-1 ANALOG OUTPUT SW1-2.

See Also

Analog Output Span (P61 / I/O 14) parameter on page 117.
 Analog Output Offset (P62 / I/O 15) parameter on page 117.
 Theory of Operation section 7.11, Phase Control on page 165.
 Theory of Operation section 7.12, Current Follower on page 167.

6 - PARAMETER DESCRIPTION

P61	Analog Output Span	I/O 14
------------	---------------------------	---------------

LED Display



LCD Display



Range 1 – 125% (**Default 100%**)

Description The analog output signal can be scaled using the Analog Output Span parameter. For a 0-10V output or 0-20mA output, a 100% scaling outputs the maximum voltage (10V) or current (20mA) when the selected output function requests 100% output. A scale of 50% outputs 50% voltage/current when the analog output function requests a 100% output.

⌘ **NOTE:** The DIP switch (SW1) on the card changes the analog input and analog output between 0-10V or 0-20mA. See Figure 18 to see DIP Switch Settings. ANALOG INPUT SW1-1 ANALOG OUTPUT SW1-2.

⌘ **NOTE:** For a 4-20mA output, set the Analog Output Span to 80% and the Analog Output Offset (P62 / I/O 15) parameter to 20%.

⌘ **NOTE:** The output does not exceed 100% (10V or 20mA).

Example: 0% output => 4mA, 100% output => 20ma

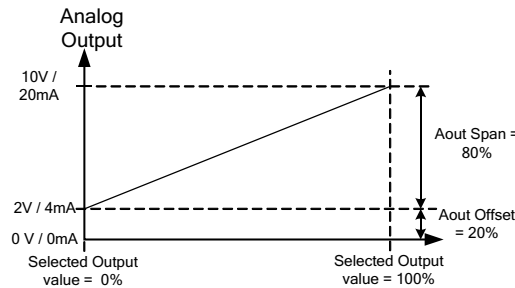

See Also Analog Output Offset (P62 / I/O 15) parameter on page 117.

P62	Analog Output Offset	I/O 15
------------	-----------------------------	---------------

LED Display



LCD Display

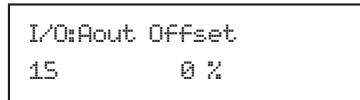

Range 0 – 99% (**Default 0%**)

Description The analog output signal can be offset using the Analog Output Offset parameter. A 50% offset outputs a 50% output (5V in the 10V case) when 0% is commanded. If the selected variable requests 100% output, the span should be reduced to (100 minus offset) so that a 100% output request causes a 100% output voltage ($x\% \text{ offset} + (100-x)\% \text{ span} = 100\%$).

⌘ **NOTE:** The DIP switch (SW1) on the card changes the analog input and analog output between 0-10V or 0-20mA. See Figure 18 to see DIP Switch Settings. ANALOG INPUT SW1-1 ANALOG OUTPUT SW1-2.

⌘ **NOTE:** For a 4-20mA output, set the Analog Output Span (P61 / I/O 14) to 80% and the Analog Output Offset to 20%.

See Also Analog Output Span (P61 / I/O 14) parameter on page 117.

6 - PARAMETER DESCRIPTION

P63

Inline Configuration

I/O 16

LED Display



LCD Display

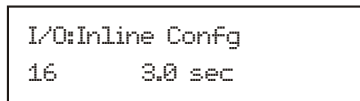

Range

Off, 0 – 10.0 seconds (**Default 3.0**)

Description

The Inline Configuration parameter controls the behavior of the No Line warning, No Line fault, and the Ready relay function.

If the Inline Configuration parameter is set to "Off", then the MX² assumes that there is no Inline contactor and that line voltage should be present while stopped. If no line is detected, then a No Line alarm condition exists and the ready condition does not exist. If a start is commanded, then a No Line fault is declared.

If the Inline Configuration parameter is set to a time delay, then the MX² assumes that there is an Inline contactor and that line voltage need not be present while stopped. If no line is detected, then the No Line alarm condition does not exist and the ready condition does exist. If a start is commanded and there is no detected line voltage for the time period defined by this parameter, then a "noL" (No Line) fault is declared.

In order to control an inline contactor, program a relay as a Run relay.

⌘ **NOTE:** This fault is different than over/under voltage trip delay time (P40 / PFN 09) since it detects the presence of NO line.

See Also

Relay Output Configuration (P52-54 / I/O 05-07) parameters on page 112.

P64

Bypass / 2M Feedback Time

I/O 17

LED Display



LCD Display

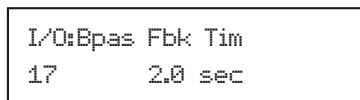

Range

Off, 0.1 – 5.0 seconds (**Default 2.0 sec**)

Description

The starter contains a built-in dedicated bypass feedback input that is enabled when the dedicated stack relay is factory programmed to "bypass". The programmable inputs DI 1, DI 2 or DI 3 may also be used to monitor an auxiliary contact from the bypass contactor(s) or in the case of a wye-delta starter the 2M contactor. The digital input is expected to be in the same state as the UTS relay. If it is not, the MX² trips on Fault 48 (Bypass Fault).

The Bypass Confirmation input must be different from the UTS relay for the time period specified by the parameter before a fault is declared. There is no alarm associated with this fault.

See Also

Digital Input Configuration (P48-P50 / I/O 01-03) parameters on page 110.
Theory of Operation section 7.8, Wye-Delta Operation on page 160.

6 - PARAMETER DESCRIPTION

P65	Keypad Stop Disable	I/O 18
------------	----------------------------	---------------

LED Display



LCD Display



Range

LED	LCD	Description
0FF	Disabled	Keypad Stop does not stop the starter
0n	Enabled	Keypad Stop does stop the starter (Default)

Description

If “Disabled”

When this parameter is set to "Disabled", the keypad [STOP] button is de-activated. This should be done with caution, as the [STOP] key will not stop the starter.

The [STOP] key cannot be disabled if the keypad is selected as the control sources, .

If “Enabled”

When this parameter is set to "Enabled", the keypad [STOP] button is enabled and stops the starter regardless of the selected control source (P4 / QST 04 or P5 / QST 05) selected as (keypad, terminal or serial).

See Also

Local Source (P4 / QST 04) parameter on page 77.
Remote Source (P5 / QST 05) parameter on page 78.

P66	Auto Start Selection	I/O 19
------------	-----------------------------	---------------

LED Display



LCD Display

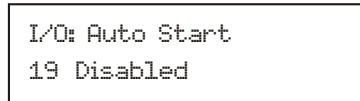

Range

LED	LCD	Description
0	Disabled	When Disabled, the Start input must always transition from low to high for a start to occur. (Default)
1	Power	When set to Power, a start will occur if the Start input is high while control power is applied.
2	Fault	When set to Fault, a start will occur if the Start input is high when a fault is reset.
3	Power, Fault	When set to Power and Fault, a start will occur if the Start input is high while control power is applied, and a start will occur if the Start input is high when a fault is reset.

Description

The Auto Start parameter determines whether or not a transition from low to high is required on the Start input for a start to occur after either a power up or a fault reset.

6 - PARAMETER DESCRIPTION

Jump to Parameter

FUN 00

By changing the value of this parameter and pressing [ENTER], you can jump directly to any parameter within that group.

P67

Miscellaneous Commands

FUN 15

LED Display

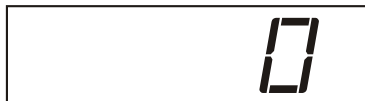

LCD Display

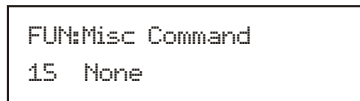

Range

LED	LCD	Description
0	None	No commands (Default)
1	Std BIST	Built In Self Test with no line voltage applied to the starter
2	Powered BIST	Built In Self Test with line voltage applied to the starter
3	Reset RT	Reset Run Time Meter
4	Reset kWh	Reset kWh/MWh Meters
5	Reflash Mode	Activate Reflash Mode
6	Store Params	The current parameter values are stored in non-volatile memory
7	Load Params	All parameter are retrieved from non-volatile memory
8	Factory Rst	All parameters are restored to the factory defaults

Description

The Miscellaneous Commands parameter is used to issue various commands to the MX² starter.

The standard BIST command will put the starter into the unpowered BIST test. See section 8.6.1 on page 188.

The powered BIST command will put the starter into a powered BIST test. See section 8.6.2 on page 189.

The Reset Run Time command resets the user run time meters back to zero (0).

The Reset kWh command resets the accumulated kilowatt-hour and megawatt-hour meters back to zero (0).

The Reflash Mode command puts the MX² into a reflash program memory mode. The reflash mode can only be entered if the MX² starter is idle. When the reflash mode is entered, the MX² waits to be programmed. The onboard LED display shows "FLSH". The remote display is disabled after entering reflash mode. The MX² does not operate normally until reflash mode is exited. Reflash mode may be exited by cycling control power.

The Store Parameters command allows the user to copy the parameters into non-volatile memory as a backup. If changes are being made, store the old set of parameters before any changes are made. If the new settings do not work, the old parameter values can be loaded back into memory.

The Load Parameters command loads the stored parameters into active memory.

The Factory Reset command restores all parameters to the factory defaults. These can be found in chapter 5.

6 - PARAMETER DESCRIPTION

P68	Communication Timeout	FUN 12
------------	------------------------------	---------------

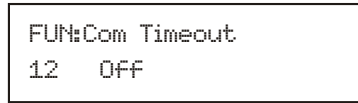
LED Display**LCD Display****Range**Off, 1 – 120 seconds (**Default Off**)**Description**

The Communication Timeout parameter sets the time that the starter continues to run without receiving a valid Modbus request. If a valid Modbus request is not received for the time that is set, the starter declares an F82 (Modbus Time Out). The starter performs a controlled stop.

See Also

Local Source (P4 / QST 04) parameter on page 77.
Remote Source (P5 / QST 05) parameter on page 78.
Stop Mode (P15 / CFN 14) parameter on page 87.
Controlled Fault Stop Enable (P43 / PFN 12) parameter on page 105.
Communication Address (P70 / FUN 10) parameter on page 121.
Communication Baud Rate (P69 / FUN 11) parameter on page 121.

P69	Communication Baud Rate	FUN 11
------------	--------------------------------	---------------

LED Display**LCD Display****Range**1200, 2400, 4800, 9600, 19200 bps (**Default 19200**)**Description**

The Communication Baud Rate parameter sets the baud rate for Modbus communications.

See Also

Local Source (P4 / QST 04) parameter on page 77 .
Remote Source (P5 / QST 05) parameter on page 78.
Communication Address (P70 / FUN 10) parameter on page 121.
Communication Timeout (P68 / FUN 12) parameter on page 121.
Communication Byte Framing (P71 / FUN 13) parameter on page 122.

P70	Communication Address	FUN 10
------------	------------------------------	---------------

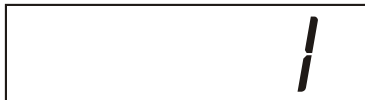
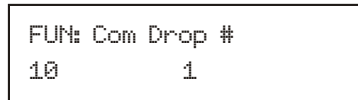
LED Display**LCD Display****Range**1 – 247 (**Default 1**)**Description**

The Communication Address parameter sets the starter's address for Modbus communications.

See Also

Local Source (P4 / QST 04) parameter on page 77.
Remote Source (P5 / QST 05) parameter on page 78.
Communication Baud Rate (P69 / FUN 11) parameter on page 121.
Communication Timeout (P68 / FUN 12) parameter on page 121.
Communication Byte Framing (P71 / FUN 13) parameter on page 122.

6 - PARAMETER DESCRIPTION

P71

Communication Byte Framing

FUN 13

LED Display



LCD Display

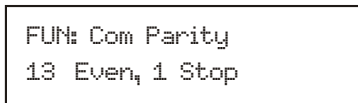

Range

LED	LCD
0	Even, 1 Stop (Default)
1	Odd, 1 Stop
2	None, 1 Stop
3	None, 2 Stop

Description

The Communication Byte Framing parameter sets both the parity and number of stop bits.

See Also

Communication Timeout (P68 / FUN 12) parameter on page 121.
Communication Baud Rate (P69 / FUN 11) parameter on page 121.
Communication Address (P70 / FUN 10) parameter on page 121.

P72

Energy Saver

FUN 09

LED Display



LCD Display

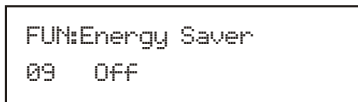

Range

On – Off (Default Off)

Description

The Energy Saver feature lowers the voltage applied to a lightly loaded motor. It continues to lower the voltage until it finds the point where the current reaches its lowest stable level and then regulates the voltage around this point. If the load on the motor increases, the starter immediately returns the output of the starter to full voltage.

⚠ **NOTE:** This function does not operate if a bypass contactor is used.

⚠ **NOTE:** In general, Energy Saver can save approximately 1000 watts per 100 HP. Consult Benshaw for further detail.

P73

Heater Level

FUN 08

LED Display



LCD Display

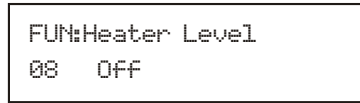

Range

Off, 1 – 25% FLA (**Default Off**)

Description

The Heater Level parameter sets the level of D.C. current that reaches the motor when the motor winding heater/anti-windmilling brake is enabled. The motor winding heater/anti-windmilling brake can be used to heat a motor in order to prevent internal condensation or it can be used to prevent a motor from rotating.

⌘ **NOTE:** The motor can still slowly creep when the anti-windmilling brake is being used. If the motor has to be held without rotating, a mechanical means of holding the motor must be used.

The motor winding heater/anti-windmilling brake operation may be controlled by a digital input and by a heater disable bit in the starter control Modbus register. There are two methods using the digital inputs, either the input is an enable or disable.

Enabled: When the DI 1, DI 2 or DI 3 inputs are programmed as Heat Enable Inputs, the input may be used to control when heating/anti-windmilling is applied. The Heater / Anti-Windmill Level parameter must be set, the starter stopped and this input must be high for heating to occur.

Disabled: When the DI 1, DI 2 or DI 3 inputs are programmed as Heat Disable Inputs, the input may be used to control when heating/anti-windmilling is applied. The Heater / Anti-Windmill Level parameter must be set and this input must be low for heating to occur.



If no digital inputs are programmed as heater enabled or disabled, the heater is applied at all times when the motor is stopped.

The level of D.C. current applied to the motor during this operation needs to be monitored to ensure that the motor is not overheated. The current level should be set as low as possible and then slowly increased over a long period of time. While this is being done, the temperature of the motor should be monitored to ensure it is not overheating.



The Motor should be labeled as being live even when not rotating.

The heater feature should not be used to dry out a wet motor.

⌘ **NOTE:** When in single phase mode, the heater function is disabled.

⌘ **NOTE:** When this function is "on", all of the other parameters cannot be programmed until this parameter is turned "off".

See Also

Digital Input Configuration (P48-50 / I/O 01-03) parameters on page 110.

6 - PARAMETER DESCRIPTION

P74	Starter Type	FUN 07
------------	---------------------	---------------

LED Display



LCD Display

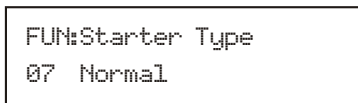

Range

LED	LCD	Description
nor	Normal	Normal Reduced Voltage Soft Starter RVSS. (Default)
ld	Inside Delta	Inside Delta, RVSS.
y-d	Wye-Delta	Wye Delta.
PctL	Phase Ctl	Open Loop Phase control using external analog input reference.
cFdL	Curr Follow	Closed Loop Current follower using external analog input reference.
AtL	ATL	Across the line. (Full Voltage)

Description

The MX² has been designed to be the controller for many control applications; Solid State Starter, both Normal (outside Delta) and Inside Delta, and Electro mechanical starters, Wye Delta, Across the line full voltage starter, Phase Control/Voltage Follower, Current Follower. In each case, the MX² is providing the motor protection and the necessary control for these applications.

⚠ **NOTE:** For single phase operation, select Normal for the Starter Type parameter, and Single Phase for the phase order parameter.

See Also

Phase Order (P77 / FUN 04) parameter on page 126.
 Theory of Operation section 7.8, Wye-Delta Operation on page 160.
 Theory of Operation section 7.11, Phase Control on page 165.
 Theory of Operation section 7.12, Current Follower on page 167.

6 - PARAMETER DESCRIPTION

P75	Motor Rated Power Factor	FUN 06
-----	--------------------------	--------

LED Display



LCD Display

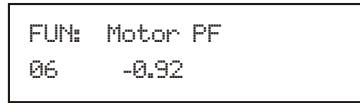

Range -0.01 – 1.00 (**Default -0.92**)

Description The Rated Power Factor parameter sets the motor power factor value that is used by the MX² starter for TruTorque and Power control calculations and metering calculations.

If TruTorque or Power acceleration and/or deceleration control is used, it is very important to properly set this parameter to the motor's full load rated power factor (usually available on the motor nameplate or from the motor manufacturer). For a typical induction motor, this value is between 0.80 and 0.95.

If the motor rated Power Factor is not available from either the motor nameplate or the motor manufacturer, the value can be obtained by viewing the power factor meter.

With the motor running at full name plate current, view the power factor meter either by setting the LED display's Meter parameter to "PF", or by pressing the [UP] arrow key until the Motor PF meter is displayed using the LCD display.

The meter value can be entered into the Rated Power Factor parameter.

See Also Meter (P79 / FUN 01) parameters on page 127.
Theory of Operation section 7.3.3, TruTorque Acceleration Control Settings and Times on page 141.
Theory of Operation section 7.3.4, Power Control Acceleration Settings and Times on page 143.

P76	Rated RMS Voltage	FUN 05
-----	-------------------	--------

LED Display



LCD Display

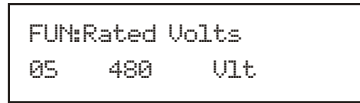

Range 100, 110, 120, 200, 208, 220, 230, 240, 350, 380, 400, 415, 440, 460, 480, 500, 525, 575, 600, 660, 690, 800, 1000, 1140 (**Default 480**)

Description The Rated Voltage parameter sets the line voltage that is used when the starter performs Over and Under line voltage calculations. This value is the supply voltage, NOT the motor utilization voltage.

See Also Meter (P79 / FUN 01) parameter on page 127.
Under Voltage Level (P39 / PFN 08) parameter on page 103.
Voltage Trip Time (P40 / PFN 09) parameter on page 104.

⚠**NOTE:** The rated RMS voltage must be set properly in order for the starter to operate properly.

6 - PARAMETER DESCRIPTION

P77	Input Phase Sensitivity	FUN 04
------------	--------------------------------	---------------

LED Display



LCD Display

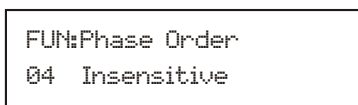

Range

LED	LCD	Description
In5	Insensitive	Runs with any three phase sequence. (Default)
ABC	ABC	Only runs with ABC phase sequence.
CBA	CBA	Only runs with CBA phase sequence.
SPH	Single phase	Single Phase.

Description

The Input Phase Sensitivity parameter sets the phase sensitivity of the starter. This can be used to protect the motor from a possible change in the incoming phase sequence. If the incoming phase sequence does not match the set phase rotation, the starter displays an Alarm while stopped and faults if a start is attempted.

P78	CT Ratio	FUN 03
------------	-----------------	---------------

LED Display



LCD Display

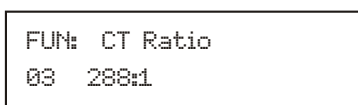

Range

72:1, 96:1, 144:1, 288:1, 864:1, 2640:1, 3900:1, 5760:1, 8000:1, 14400:1, 28800:1 **(Default 288:1)**

Description

The CT ratio must be set to match the CTs (current transformers) supplied with the starter. This allows the starter to properly calculate the current supplied to the motor.

Only Benshaw supplied CTs can be used on the starter. The CTs are custom 0.2 amp secondary CTs specifically designed for use on the MX² starter. The CT ratio is then normalized to a 1A secondary value. The supplied CT ratio can be confirmed by reading the part number on the CT label. The part number is of the form BICTxxx1M, where xxx is the CT primary and the 1 indicates the normalized 1 amp.

⚠ **NOTE:** It is very important that the CT ratio is set correctly. Otherwise, many starter functions will not operate correctly.

Refer to Table 3 - CT Ratios on page 13.

6 - PARAMETER DESCRIPTION

P79

Meter 1 ,Meter 2

FUN 01, 02

LED Display



LCD Display

```

FUN: Meter 1
01 Ave Current
    
```

```

FUN: Meter 2
02 Ave Volts
    
```

Range

LED	LCD	Description
0	Status	Running State. (LED meter only, Default LED meter)
1	Ave Current	Average current. (Default LCD Meter 1)
2	L1 Current	Current in phase 1.
3	L2 Current	Current in phase 2.
4	L3 Current	Current in phase 3.
5	Curr Imbal	Current Imbalance %.
6	Ground Fault	Residual Ground Fault % FLA.
7	Ave Volts	Average Voltage L-L RMS. (Default LCD Meter 2)
8	L1-L2 Volts	Voltage in, L1 to L2 RMS.
9	L2-L3 Volts	Voltage in, L2 to L3 RMS.
10	L3-L1 Volts	Voltage in, L3 to L1 RMS.
11	Overload	Thermal overload in %.
12	Power Factor	Motor power factor.
13	Watts	Motor real power consumed.
14	VA	Motor apparent power consumed.
15	vars	Motor reactive power consumed.
16	kW hours	Kilo-watt-hour used by the motor, wraps at 1,000.
17	MW hours	Mega-watt-hour used by the motor, wraps at 10,000.
18	Phase Order	Phase Rotation.
19	Line Freq	Line Frequency.
20	Analog In	Analog Input %.
21	Analog Out	Analog Output %.
22	Run Days	Running time in days, wraps at 2,730 days.
23	Run Hours	Running time in Hours and Minutes, wraps at 24:00.
24	Starts	Number of Starts, wraps at 65,536.
25	TruTorque %	TruTorque %.
26	Power %	Power %.
27	Pk accel Curr	Peak starting current.
28	Last Start T	Last starting duration.

Description

For the LED display, this parameter configures which single meter is displayed on the main screen. For the LCD display, parameters FUN 01 and FUN 02 configure which meters are displayed on the two lines of the main display screen.

6 - PARAMETER DESCRIPTION

P80	Software 1	FUN 14
-----	------------	--------

LED Display



LCD Display

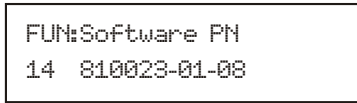

Description

The Software Part Number parameter displays the MX² software version, for hardware BIPC-300055-01-04. When calling Benschaw for service, this number should be recorded so it can be provided to the service technician.

In addition to viewing the software version with this parameter, the software version is also displayed on power up. On the LED display, the software version is flashed one character at a time on power up. On the LCD display, the software PN is fully displayed on power up.

⌘ NOTE: The seven segment LED in position one will flash the current software version currently in use when first powered on. The full software part number will flash consecutively (one digit per second),

For Example: 8...1...0...0...2...3...-...0...1...-...0...8

6 - PARAMETER DESCRIPTION

P81	Passcode	FUN 16
-----	----------	--------

LED Display



LCD Display

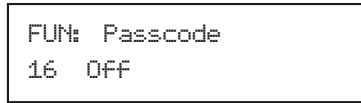

Description

The MX² supports a 4-digit passcode. When the passcode is set, parameters may not be changed.

The MX² provides a means of locking parameter values so that they may not be changed. Once locked, the parameters values may be viewed on the display, but any attempt to change their values by pressing the [UP] or [DOWN] keys is ignored.

Viewing the Passcode parameter indicates whether or not the parameters are locked. If they are locked, the Passcode parameter displays "On". If they are not locked, the Passcode parameter displays "Off".

To lock the parameters, press the [ENTER] key while viewing the Passcode parameter. This allows entry of a 4-digit number. Press the [UP] or [DOWN] keys and [ENTER] for each of the four digits. After entering the fourth digit, the number is stored as the passcode and the parameters are locked.

Once parameters are locked, the same 4-digit number must be re-entered into the Passcode parameter in order to unlock them. Any other 4-digit number entered will be ignored.

When a passcode is set and an attempt is made to change a parameter through the display/keypad, the [UP] and [DOWN] keys simply have no effect. When a passcode is set and an attempt is made to change a parameter through Modbus, the MX² returns an error response with an exception code of 03 (Illegal Data Value) to indicate that the register can not be changed.

LED Display

The following steps must be performed to set a passcode using the LED Display:

1. At the default meter display, press the [PARAM] key to enter the parameter mode.
2. Press the [UP] or [DOWN] keys to get to the Passcode parameter (P81 / FUN 16).
3. Press the [ENTER] key. "Off" is displayed to indicate that no passcode is currently set.
4. Press the [UP] or [DOWN] keys and [ENTER] for each digit to be defined, select a value from 0000 to 9999 starting at the most significant digit.
5. Press the [ENTER] key to set the passcode.

The following steps must be performed to clear a passcode.

1. At the default meter display, press the [PARAM] key to enter the parameter mode.
2. Press the [UP] or [DOWN] keys to get to the Passcode parameter (P81 / FUN 16).
3. Press the [ENTER] key. "On" is displayed to indicate that a passcode is presently set.
4. Press the [UP] or [DOWN] keys and [ENTER] after each digit to select the previously set passcode value.
5. Press the [ENTER] key. The passcode is then cleared.

6 - PARAMETER DESCRIPTION

P82	Fault Log	FL1
-----	-----------	-----

LED Display



LCD Display

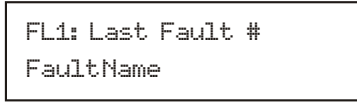

Range

FL1 – FL9

Description

When a fault occurs, the fault number is logged in non-volatile memory. The most recent fault is in FL1 and the oldest fault is in FL9.

If the starter is equipped with an LCD display, pressing [ENTER] toggles through the Starter data recorded at the time of the fault. See section 4.13.3 on page 56 for more information.

See Also

Fault Codes on page 196.

7 Theory of Operation

7 - THEORY OF OPERATION

Motor Overload

7.1 Solid State Motor Overload Protection

7.1.1 Overview

The MX² contains an advanced I²t electronic motor overload (OL) protection function. For optimal motor protection, the MX² has forty standard NEMA style overload curves (in steps of one) available for use. Separate overload classes can be programmed for acceleration and for normal running operation and individually or completely disabled if necessary. The MX² motor overload function also implements a NEMA based current imbalance overload compensation, adjustable hot and cold motor compensation, and adjustable exponential motor cooling.



CAUTION: If the MX² motor overload protection is disabled during any mode of operation, external motor overload protection must be provided to prevent motor damage and/or the risk of fire in the case of a motor overload.

7.1.2 Setting Up The MX² Motor Overload

Motor overload protection is easily configured through seven parameters (please refer to the descriptions of each parameter in section 6 of this manual for additional parameter information):

1. Motor FLA (QST 01)
2. Motor Service Factor (QST 02)
3. Motor Running Overload Class (PFN 15)
4. Motor Starting Overload Class (PFN 14)
5. Independent Starting/Running Overload (PFN 13)
6. Motor Overload Hot/Cold Ratio (PFN 16)
7. Motor Overload Cooling Time (PFN 17)

The Motor FLA and Service Factor parameter settings define the motor overload "pickup" point. For example, if the motor service factor is set to 1.00, the motor overload begins accumulating or incrementing when the measured motor current is >100% FLA (100% * 1.00). The overload will NOT trip if the motor current is <100%. If the motor service factor is set to 1.15, the overload starts accumulating content when the motor current >115% FLA (100% * 1.15). The overload will NOT trip if the measured motor current is <115% of rated FLA.

The available overload classes are based on the trip time when operating at 600% of rated motor current. For example, a Class 10 overload trips in 10 seconds when the motor is operating at 600% rated current; a Class 20 overload trips in 20 seconds when the motor is operating at 600% rated current.

The equation for the MX² standard overload curves after the "pick-up" point has been reached is:

$$\text{Time to Trip (seconds)} = \frac{35 \text{ seconds} * \text{Class}}{\left(\frac{\text{Measured Current} * \text{Current Imbal Derate Factor}}{\text{Motor FLA}} \right)^2}$$

Figure 25: Commonly Used Overload Curves

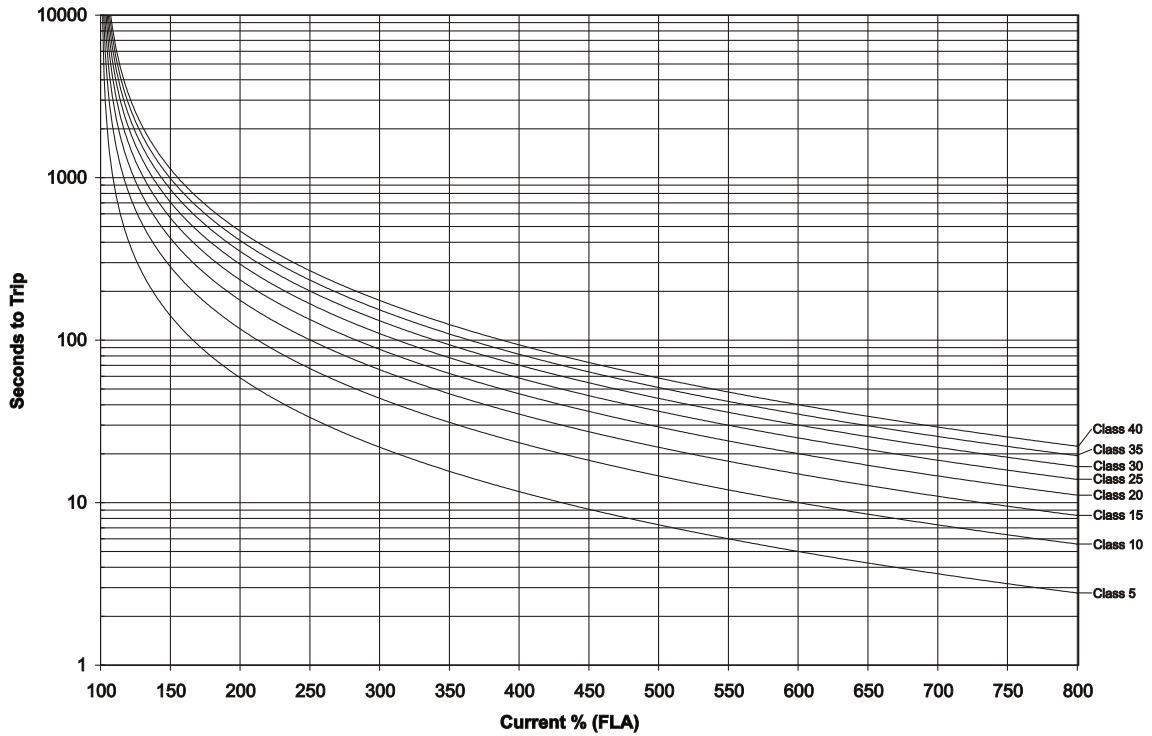

⚠ **NOTE:** In some cases the power stack rating may determine what motor overload settings are available. Each power stack is designed to support specific motor overload classes. The RB2 power stack is designed for class 10 duty without derating. Refer to the RB2 for the specific RB2 overload capabilities. Also, in certain heavy duty DC braking applications, the overload settings may be limited to protect the motor from potential damage during braking.

Visit the web at www.benshaw.com for an automated overload calculator.

7 - THEORY OF OPERATION

7.1.3 Motor Overload Operation

Overload Heating

When the motor is operating in the overloaded condition (motor current greater than FLA_xSF), the motor overload content accumulates based on the starter's operating mode at a rate established by the overload protection class chosen. The accumulated overload content can be viewed on the display or over the communications network.

Overload Alarm

An overload alarm condition is declared when the accumulated motor overload content reaches 90%. An output relay can be programmed to change state when a motor overload alarm condition is present to warn of an impending motor overload fault.

Overload Trip

The MX² starter trips when the motor overload content reaches 100%, protecting the motor from damage. The starter first performs the defined deceleration or DC braking profile before stopping the motor if the controlled fault stop feature of the MX² is enabled. The motor overload trip time accuracy is ± 0.2 seconds or ± 3% of total trip time.

Overload Start Lockout

After tripping on an overload, restarting is prevented and the starter is "locked out" until the accumulated motor overload content has cooled below 15%.

7.1.4 Current Imbalance / Negative Sequence Current Compensation

The MX² motor overload calculations automatically compensate for the additional motor heating which results from the presence of unbalanced phase currents. There can be significant negative sequence currents present in the motor when a current imbalance is present. These negative sequence currents have a rotation opposite the motor rotation and are typically at two times the line frequency. Due to the negative sequence currents opposite rotation and higher frequency, these currents can cause a significant increase in rotor heating.

The overload curves provided by a motor manufacturer are based on balanced motor operation. Therefore, if a current imbalance is present, the MX² motor overload compensates for the additional heating effect by accumulating overload content faster and tripping sooner to protect the motor. The current imbalance compensation also adjusts the Hot / Cold motor protection as described below in section 7.1.6. The MX² derating factor is based on NEMA MG-1 14.35 specifications and is shown in Figure 26.

Figure 26: Overload Derating for Current Imbalance

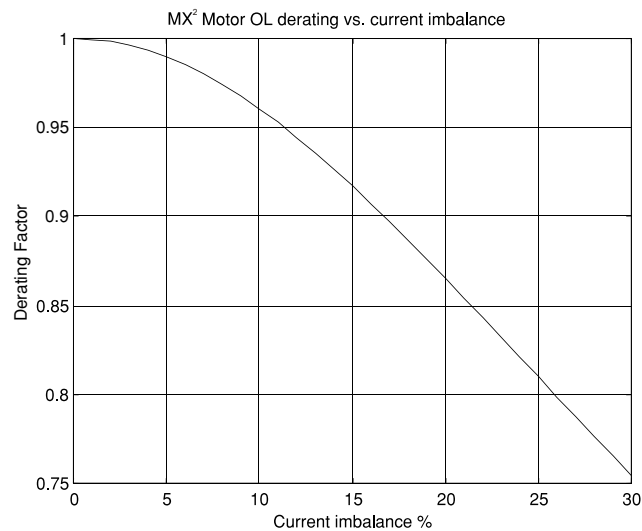

7.1.5 Harmonic Compensation

The MX² motor overload calculation automatically compensates for the additional motor heating that can result from the presence of harmonics. Harmonics can be generated by other loads connected to the supply such as DC drives, AC variable frequency drives, arc lighting, uninterruptible power supplies, and other similar loads.

7.1.6 Hot / Cold Motor Overload Compensation

If a motor has been in operation for some time, it will have heated up to some point. Therefore, there is typically less overload content available in the case where a motor is restarted immediately after it has been running when compared to the situation where a motor has been allowed to cool down before restarting. The MX² provides adjustable hot motor overload compensation to fully protect the motor in these cases.

If the hot and cold maximum locked rotor times are provided, the MX² Hot/Cold Ratio parameter value can be calculated as follows:

If no motor information is available, a Hot/Cold ratio value of 60% is usually a good starting point.

$$\text{OL H/C Ratio} = 1 \frac{\text{Max Hot Locked Rotor Time}}{\text{Max Cold Locked Rotor Time}} \times 100\%$$

The MX² adjusts the actual motor overload content based on the programmed Hot/Cold Ratio set point and the present running current of the motor so that the accumulated motor overload content accurately tracks the thermal condition of the motor. If the motor current is constant, the overload content eventually reaches a steady state value. This value is derived as follows:

$$\text{OL}_{ss} = \text{OL H/C Ratio} \frac{\text{Current}}{\text{FLA}} \frac{1}{\text{Current Imbalance Derate Factor}}$$

The running OL content is also adjusted based on the derating factor due to the presence of any current imbalances and or harmonics.

If the existing motor overload content is less than the calculated running OL content, the motor overload exponentially increases the overload content until the appropriate running overload content level is achieved. If the existing motor overload content is greater than the calculated running OL content level, the overload exponentially cools down or decreases to the appropriate running overload content level. The rate of the running motor overload heating or cooling is controlled by the Motor Overload Cooling Time parameter.

7 - THEORY OF OPERATION

The following diagram illustrates how the current and the Motor Overload Hot/Cold Ratio parameter determines the steady state overload content. It assumes there is no current imbalance.

Figure 27: Motor Overload H^oC Ratio Example

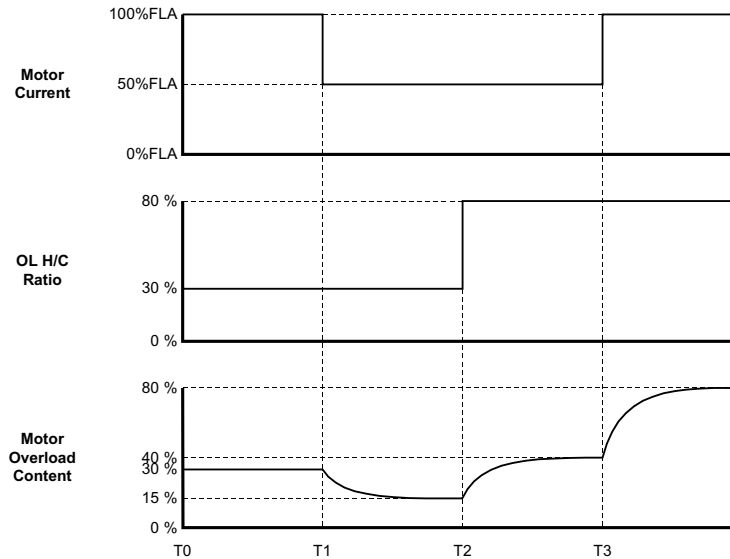

At time T0, the motor current is 100%FLA and the OL H^oC Ratio is set at 30%. It is assumed that the motor has been running for some time and the motor overload content has reached a steady state value of 30% (30% H^oC Ratio x 100% FLA = 30%).

At time T1, the motor current drops to 50%FLA. The motor overload content exponentially cools to a new steady state value of 15% (30% H^oC Ratio x 50% FLA = 15%).

At time T2, the OL H^oC Ratio is set to 80%. The motor overload content exponentially rises to a new steady state value of 40% (80% H^oC Ratio x 50% FLA = 40%).

At time T3 the motor current rises back up to 100%FLA. The motor overload content exponentially rises to a new steady state value of 80% (80% H^oC Ratio x 100% FLA = 80%).

7.1.7 Separate Starting and Running Motor Overload Settings

If desired, separate overload classes can be programmed for use during starting and during running. The motor overload protection may also be disabled during starting or during normal running. In order to enable separate overload settings the Independent Starting/Running Overload parameter needs to be set to "On" to allow independent overload operation. Once set to "On", the individual Motor Starting Overload Class and Motor Running Overload Class parameters can be set to either "Off" or the desired overload class settings.

The Motor Starting Overload Class parameter value is used for the motor overload calculations when the starter is starting the motor (kick mode, acceleration, and running before up-to-speed has been declared). Once the motor has reached full speed and during deceleration or braking, the Motor Running Overload Class is used for the motor overload calculations. As the motor protection curves shift from the acceleration curve to the running curve, the accumulated overload content is retained to provide a seamless transition from one mode of operation to the other.

Disabling the Starting OL function or using a higher OL class for the Starting OL can be useful on extremely high inertial loads such as large centrifuges or high friction loads that require very long starting periods.

⚠ **NOTE:** When the Independent Starting/Running Overload (P44 / PFN 13) parameter is set to "OFF", the running OL is used at all times.

⚠ **NOTE:** The Hot/Cold motor compensation is still active when either the starting or running overload is disabled. Therefore the motor overload content may still slowly increase or decrease depending on the measured motor current. However if the motor overload is disabled, the motor overload content is limited to a maximum of 99%. Therefore, a motor overload trip can not occur.



CAUTION: When both overloads are disabled, the accumulated overload content is set to zero (0%) and the starter does not provide any motor overload protection. External motor overload protection must be provided to prevent motor damage and/or the risk of fire in the case of a motor overload.

7.1.8 Motor Cooling While Stopped

The Motor Overload Cooling Time parameter is used to adjust the cooling rate of the motor overload. When the motor is stopped and cooling, the accumulated motor overload content is reduced in an exponential manner.

$$\text{OL Content} = \text{OL Content when Stopped} * e^{-\frac{t}{\text{CoolingTime}}}$$

When the motor is stopped, the motor overload cools as shown in the following Figure 28.

Figure 28: Motor Cooling While Stopped Curves

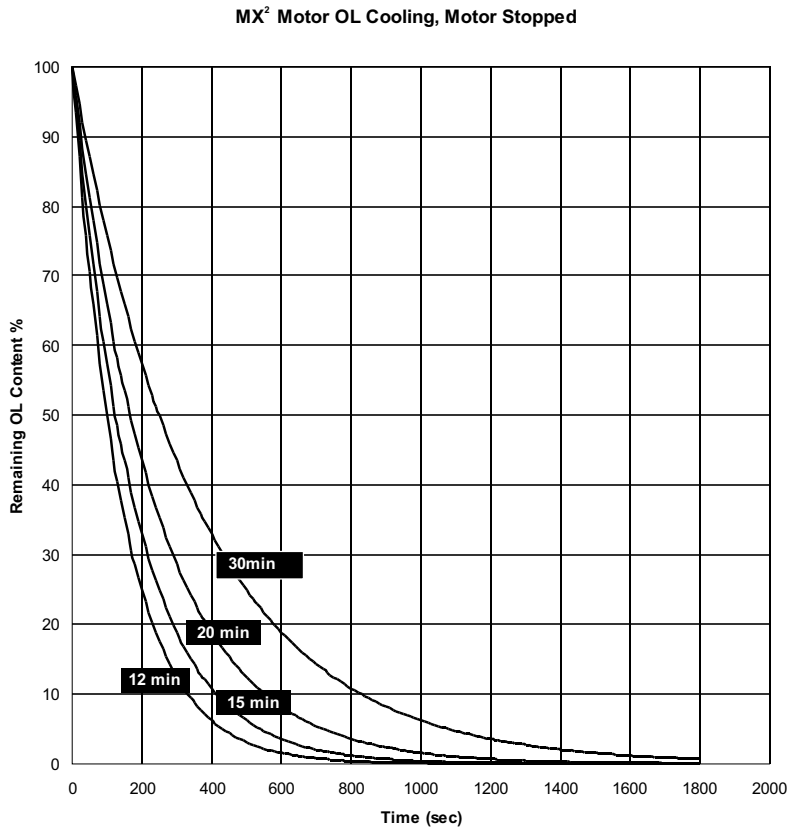

7 - THEORY OF OPERATION

If the motor manufacturer does not specify the motor cooling time, the following approximations for standard TEFC cast iron motors based on frame size can be used:

Frame Size	Cooling Time
180	30 min
280	60 min
360	90 min
400/440	120 min
500	180 min
Larger frames	Consult Manufacturer

For motors less than 300hp, another approximation based on allowable motor starts per hour can also be used to set an initial value of the Motor Overload Cooling Time parameter:

$$\text{Motor Cooling Time (minutes)} = \frac{60 \text{ minutes}}{\text{Starts per hour}}$$

The Motor Overload Cooling Time parameter is defined as the time that it takes for the motor to cool from 100% overload content to less than 1% overload content. Sometimes a motor manufacturer may provide a cooling time constant (t or tau) value. In these cases, the Motor Overload Cooling Time parameter should be set to five (5) times the specified time constant value.

7.1.9 Motor Cooling While Running

When the motor is running, the Motor Overload Cooling Time parameter and the Motor Overload Hot/Cold Ratio parameter settings control the motor OL content. If the motor overload content is above the steady state OL running level (See section 7.1.6, Hot / Cold Motor Overload Compensation for more details) the motor OL exponentially cools to the appropriate steady state OL level. When the motor is running, the cooling time is adjusted based on the measured current level and current imbalance level at which the motor is operating.

$$\text{Cooling Time Running} = \text{Cooling Time Stopped} * \frac{\text{Measured Running Current}}{\text{Motor FLA}} * \frac{1}{\text{Current Imbalance Derate Factor}}$$

In all cases, the running motor cooling time is shorter (motor will cool faster) than when the motor is stopped. The faster cooling results because it is assumed that when a motor is running, cooling air is being applied to the motor.

7.1.10 Emergency Motor Overload Reset

The MX² has an emergency motor overload reset feature that allows the user to override the overload starter lockout. This resets the motor overload content to 0%. It does not reset the overload fault.

To perform an emergency overload reset, simultaneously press the [RESET] and [DOWN] buttons on the keypad. An emergency overload reset may also be performed by applying 120 Volts to a digital input that is configured as an emergency overload reset input or by setting the emergency overload reset bit in the starter control Modbus register.



CAUTION: This feature should only be used in an emergency. Before an emergency reset is performed the cause of the motor overload should be investigated to ensure that the motor is capable of restarting without causing undesired motor or load damage. When the emergency motor overload reset is used, the accumulated motor overload content is reset back to zero (0%). Therefore, the MX²'s motor protection functions may not be able to fully protect the motor from damage during a restart after performing an emergency motor overload reset.

Motor Service Factor

7.2 Motor Service Factor

General

The Motor Service Factor parameter should be set to the service factor of the motor. The service factor is used to determine the "pick up" point for the overload calculations. If the service factor of the motor is not known then the service factor should be set to 1.00.

⚠ **NOTE:** The NEC (National Electrical Code) does not allow the service factor to be set above 1.40. Check with other local electrical codes for their requirements.

The National Electrical Code, article 430 Part C, allows for different overload multiplier factors depending on the motor and operating conditions. NEC section 430-32 outlines the allowable service factor for different motors as follows:

Motor Overload Multiplier

Service factor 1.15 or more	1.25
Motor temp. rise 40°C or less	1.25
All others	1.15

NEC section 430-34 permits further modifications if the service factor is not sufficient to start the motor:

Motor Overload Multiplier

Service factor 1.15 or more	1.40
Motor temp. rise 40°C or less	1.40
All others	1.30

Although the NEC does not address the effect of the ambient temperature of the motor location, guidance can be derived by examining NEC limits. If the motor is operating in an ambient temperature that is less than 40°C, then the overload multiplier can be increased while still protecting the motor from exceeding its maximum designed temperature. The following curve gives the ambient temperature versus the correction factor.

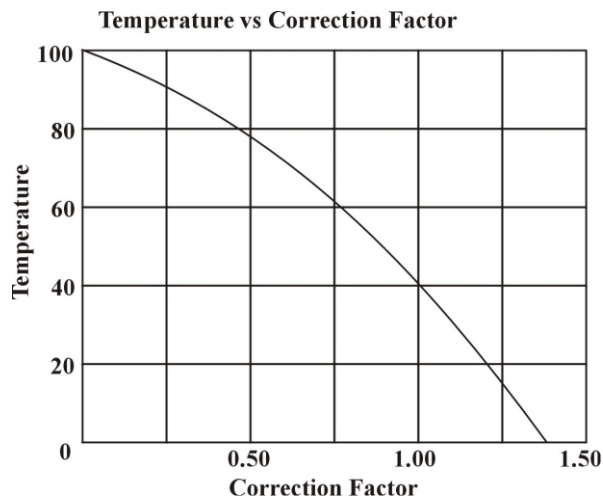

Example: If a motor operates at 0°C, then a 1.36 correction factor could be applied to the overload multiplier. This could give a theoretical overload multiplier of 1.36 x 1.25 or 1.70. The highest legal NEC approved value of overload multiplier is 1.40, so this could be used.

7 - THEORY OF OPERATION

Acceleration Control

7.3 Acceleration Control

7.3.1 Current Ramp Settings, Ramps and Times

General

The current ramp sets how the motor accelerates. The current ramp is a linear increase in current from the initial setting to the maximum setting. The ramp time sets the speed of this linear current increase. The following figure shows the relationships of these different ramp settings.

Figure 29: Current Ramp

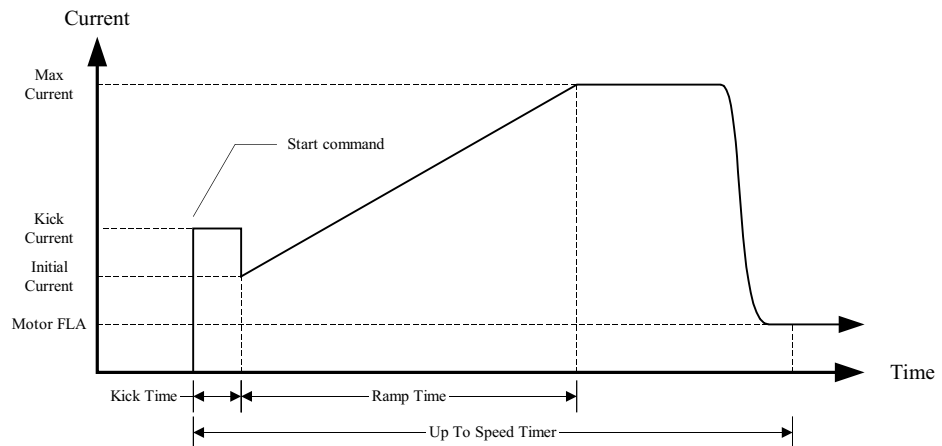

Initial Current

The initial current should be set to the level that allows the motor to begin rotating within a couple of seconds of receiving a start command.

To adjust the initial current setting, give the starter a run command. Observe the motor to see how long it takes before it begins rotating and then stop the unit. For every second that the motor doesn't rotate, increase the initial current by 20%. Typical loads require an initial current in the range of 50% to 175%.

Maximum Current

For most applications, the maximum current can be left at 600%. This ensures that enough current is applied to the motor to accelerate it to full speed.

The maximum current can also be set to a lower current limit. This is usually done to limit the voltage drop on the power system or to limit the torque the motor produces to help prevent damage to the driven load.

⚠ **NOTE:** The motor may achieve full speed at any time during the current ramp. This means that the maximum current setting may not be reached. Therefore, the maximum current setting is the most current that could ever reach the motor, and not necessarily the maximum current that reaches the motor.



⚠ **NOTE:** When setting a current limit, the motor must be monitored to ensure that the current is high enough to allow the motor to reach full speed under worst case load conditions.

Ramp Time

The ramp time is the time it takes for the current to go from the initial current to the maximum current. To make the motor accelerate faster, decrease the ramp time. To make the motor accelerate slower, increase the ramp time.

If the ramp time expires before the motor reaches full speed, the starter maintains the maximum current level until either the motor reaches full speed, the Up to Speed time expires, or the motor thermal overload trips.

⌘ **NOTE:** Setting the ramp time to a specific value does not necessarily mean that the motor will take this time to accelerate to full speed. The motor and load may achieve full speed before the ramp time expires if the application does not require the set ramp time and maximum current to reach full speed. Alternatively, the motor and load may take longer than the set ramp time to achieve full speed.

7.3.2 Programming A Kick Current

General

The kick current sets a constant current level that is applied to the motor before the ramp begins. The kick current is only useful on motor loads that are hard to get rotating but then are much easier to move once they are rotating. An example of a load that is hard to get rotating is a ball mill. The ball mill requires a high torque to get it to rotate the first quarter turn (90°). Once the ball mill is past 90° of rotation, the material inside begins tumbling and it is easier to turn.

Kick Level

The kick current parameter is usually set to a low value and then the kick time is adjusted to get the motor rotating. If the kick time is set to more than 2.0 seconds without the motor rotating, increase the kick current by 100% and re-adjust the kick time.

Kick Time

The kick time adjustment should begin at 0.5 seconds and be adjusted by 0.1 or 0.2 second intervals until the motor begins rotating. If the kick time is adjusted above 2.0 seconds without the motor rotating, start over with a higher kick current setting.

7.3.3 TruTorque Acceleration Control Settings and Times

General

TruTorque acceleration control is a closed loop torque based control. The primary purpose of TruTorque acceleration control is to smoothly start motors and to reduce the torque surge that can occur as an AC induction motor comes up to speed. This torque surge can be a problem in applications such as pumps and belt driven systems. In pumping applications, this torque surge can result in a pressure peak as the motor comes up to speed. In most situations this small pressure peak is not a problem. However in selected cases, even a small pressure rise can be highly undesirable. In belt driven applications, TruTorque can prevent the slipping of belts as the motor reaches full speed.

Figure 30: TruTorque Ramp

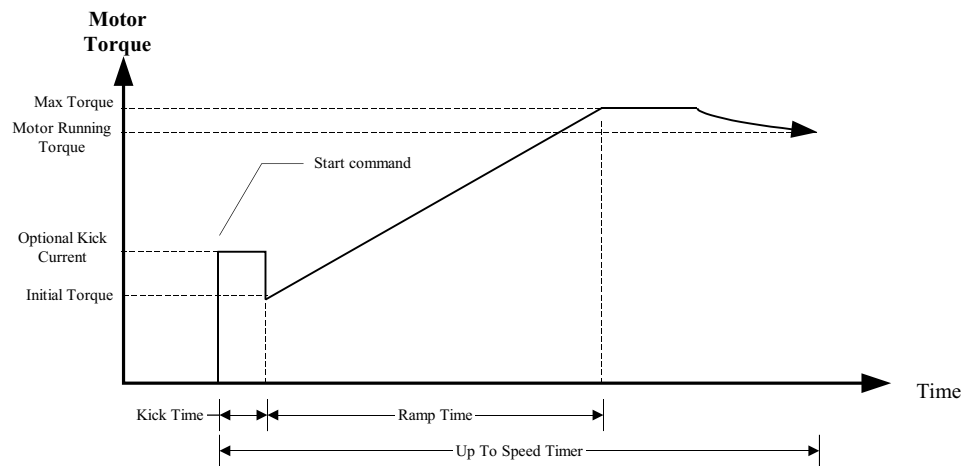

7 - THEORY OF OPERATION

TruTorque acceleration control can be very useful for a variety of applications. However it is best used to start centrifugal pumps, fans, and other variable torque applications. TruTorque generally should not be used in applications where the starting load varies greatly during the start such as with a reciprocating compressor, where the starting load is very low, or where the starting load varies greatly from one start to another. TruTorque control is not recommended for the starting of AC synchronous motors.

Initial Torque

This parameter sets the initial torque level that the motor produces at the beginning of the starting ramp profile. A typical value is 10% to 20%. If the motor starts too quickly or the initial motor torque is too high, reduce this parameter. If the motor does not start rotating within a few seconds after a start is commanded, increase this parameter. If the value is set too low a "No Current at Run" fault may occur.

Maximum Torque

This parameter sets the final or maximum torque level that the motor produces at the end of the acceleration ramp time. For a loaded motor, the maximum torque value initially should be set to 100% or greater. If the maximum torque value is set too low, the motor may not produce enough torque to reach full speed and may stall. On lightly loaded motors, this parameter may be reduced below 100% to produce smoother starts.

If the motor can be started by using the default TruTorque acceleration parameter values or another ramp profile, the Maximum Torque level can be determined more precisely so that the motor comes up to speed in approximately the preset ramp time. In this case, while the motor is running fully loaded, display the TruTorque percent (TT%) meter on the display. Record the value displayed. The Maximum Torque level should then be set to the recorded full load value of TT% plus an additional 10%. Restart the motor with this value to verify correct operation.

⚠ **NOTE:** When setting the Maximum Torque value, the motor must be monitored to ensure that the torque level is high enough to allow the motor to reach full speed under worst-case load conditions.

⚠ **NOTE:** Depending on loading, the motor may achieve full speed at any time during the TruTorque ramp. This means that the Maximum Torque level may never be achieved. Therefore, the maximum torque level is the maximum TruTorque level that is permitted. However the motor torque may not necessarily reach this value during all starts.

Ramp Time

When in TruTorque acceleration mode, the ramp time setting is the time it takes for the torque to go from the initial torque setting to the maximum torque setting. To make the motor accelerate faster, decrease the ramp time. To make the motor accelerate slower, increase the ramp time.

If the ramp time expires before the motor reaches full speed, the starter maintains the Maximum Torque level until either the motor reaches full speed, UTS timer expires, or the motor thermal overload protection trips.

⚠ **NOTE:** Setting the ramp time to a specific value does not necessarily mean that the motor takes that exact amount of time to accelerate to full speed. The motor and load may achieve full speed before the ramp time expires if the load does not require the set ramp time or set torque level to reach full speed. Alternately, the motor and load may take longer than the set ramp time to achieve full speed depending on the parameter settings and load level.

7.3.4 Power Control Acceleration Settings and Times

General

Power control is a closed loop power based acceleration control. The primary purpose of Power controlled acceleration is to control and limit the power (kW) drawn from the power system and to reduce the power surge that may occur as an AC induction motor comes up to speed. This power surge can be a problem in applications that are operated on generators or other limited or "soft" power systems. Power control also reduces the torque surge that can also occur as an AC induction motor comes up to speed.

Figure 31: Power Ramp

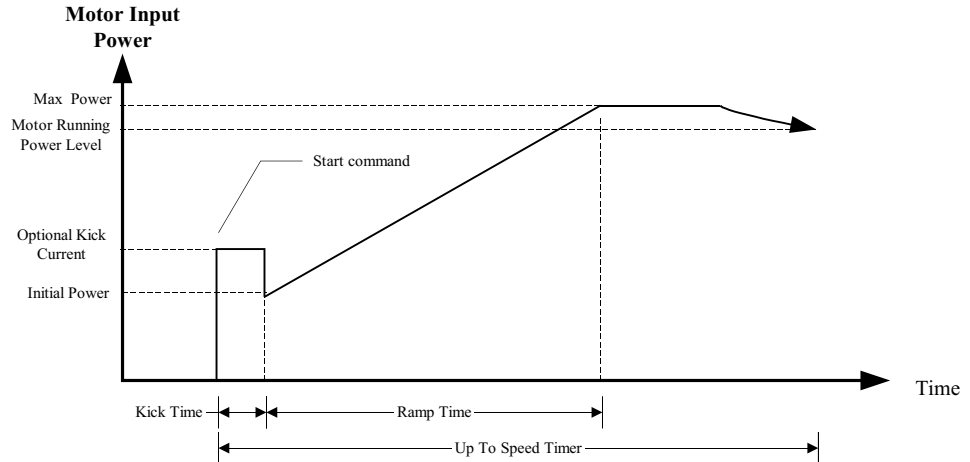

Power control acceleration can be very useful for a variety of applications. Power control generally should not be used in applications where the starting load varies greatly during the start such as with a reciprocating compressor. Power control is not recommended for starting of AC synchronous motors.

Initial Power

This parameter sets the initial power level that the motor draws at the beginning of the starting ramp profile. A typical value is usually 10% to 30%. If the motor starts too quickly or the initial power level is too high, reduce this parameter. If the motor does not start rotating within a few seconds after a start is commanded, increase this parameter. If this value is set too low a "No Current at Run" fault may occur.

Maximum Power

This parameter sets the final or maximum power level that the motor produces at the end of the acceleration ramp. For a loaded motor, the maximum power level initially should be set to 100% or greater. If the maximum power level value is set too low, the motor may not produce enough torque to reach full speed and may stall. On lightly loaded motors, this parameter may be reduced below 100% to produce smoother starts.

If the motor can be started by using the default Power acceleration parameter values or the Current control ramp, the Maximum Power level can be determined more precisely so that the motor comes up to speed in approximately the preset ramp time. In this case, while the motor is running fully loaded, display the Power percent (KW%) meter on the display. Record the value displayed. The Maximum Power level should then be set to the recorded full load value of KW% plus an additional 5% to 10%. Restart the motor with this value to verify correct operation.

⚠ **NOTE:** When setting the Maximum Power level, the motor must be monitored to ensure that the starting power is high enough to allow the motor to reach full speed under worst case load conditions.

7 - THEORY OF OPERATION

⌘ **NOTE:** Depending on loading, the motor may achieve full speed at any time during the Power ramp. This means that the Maximum Power level may not be reached. Therefore, the maximum power level is the maximum power level that is permitted. However, the motor power may not necessarily reach this value during all starts.

Ramp Time

When in Power acceleration mode, the ramp time setting is the time it takes for the power to go from the initial power setting to the maximum power setting. To make the motor accelerate faster, decrease the ramp time. To make the motor accelerate slower, increase the ramp time.

If the ramp time expires before the motor reaches full speed, the starter maintains the Maximum Power level until either the motor reaches full speed, the UTS timer expires, or the motor thermal overload protection trips.

⌘ **NOTE:** Setting the ramp time to a specific value does not necessarily mean that the motor takes that exact amount of time to accelerate to full speed. The motor and load may achieve full speed before the ramp time expires if the load does not require the set ramp time or set power level to reach full speed. Alternately, the motor and load may take longer than the set ramp time to achieve full speed depending on the parameter settings and load level.

7.3.5 Open Loop Voltage Ramps and Times

General

The open loop voltage ramp provides soft starting of a motor by increasing the voltage applied to motor from the Initial Voltage setting to full (100%) line voltage. The ramp time sets the speed at which the voltage is increased. Because this is an open loop control profile, the motor current during starting tends to be reduced; however, the current is not limited to any particular level. This starting mode (old), is not commonly used except in special circumstances. In most applications, the use of one of the other closed loop starting profiles is recommended.

Figure 32: Voltage Ramp

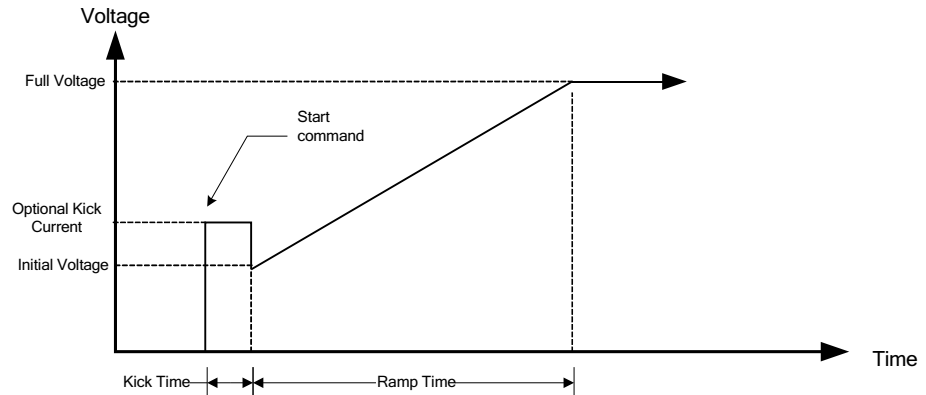

Initial Voltage

This parameter sets the initial voltage level that is applied to the motor. To adjust the starting voltage level, give the starter a run command and observe the motor operation. If the motor starts too quickly reduce the initial voltage level. If the motor does not start rotating immediately or starts too slowly then increase the initial voltage level until the motor just starts to rotate when a start command is given. If the initial voltage level is set too low, a Fault 39 - No Current at Run may occur. In this case increase the initial voltage level to permit more current to initially flow to the motor.

Ramp Time

The ramp time setting is the time that it takes for the applied voltage to go from the initial voltage level to the full voltage (100%) level. To make the motor accelerate faster, decrease the ramp time. To make the motor accelerate slower, increase the ramp time.

7 - THEORY OF OPERATION

UTS Timer

When the start mode is set to open-loop voltage ramp acceleration, the UTS Timer acts as an acceleration kick. When the UTS timer expires, full voltage is applied to the motor. This feature can be used to reduce motor surging that may occur near the end of an open loop voltage ramp start. If a surge occurs near the end of the ramp, set the UTS timer to expire at this time and restart the motor. If the surge still occurs, set the UTS time to a lower time until the surging subsides. If motor surging continues to be a problem, it is recommended that one of the other standard MX² closed-loop starting profiles be used.

Figure 33: Effect of UTS Timer on Voltage Ramp

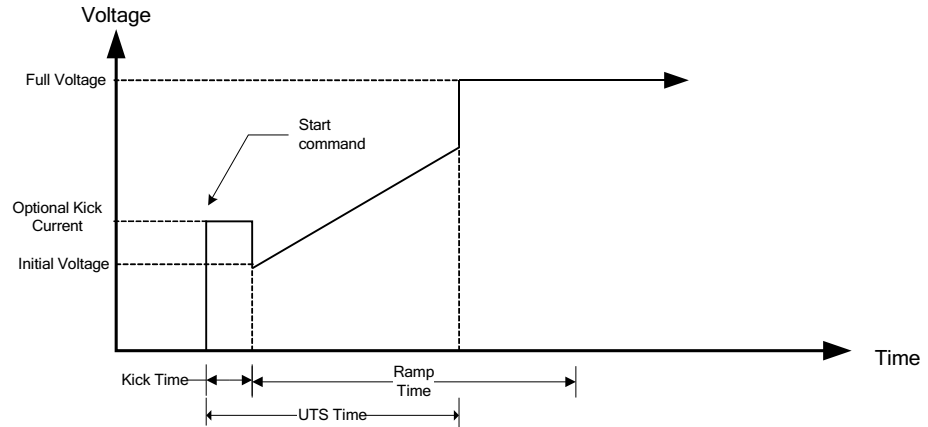

7.3.6 Dual Acceleration Ramp Control

General

Two independent current ramps and kick currents may be programmed. The use of two different starting profiles can be very useful with applications that have varying starting loads such as conveyors that can start either loaded or unloaded.

The Current Ramp 1 profile is programmed using the parameters Initial Current 1, Maximum Current 1, and Ramp Time 1. The Current Ramp 2 is programmed using the parameters Initial Current 2, Maximum Current 2, and Ramp Time 2. Kick Current 1 profile is programmed using the parameters Kick Level 1 and Kick Time 1. Kick Current 2 profile is programmed using the parameters Kick Level 2 and Kick Time 2.

Acceleration Ramp Selection

Current Ramp 2 and Kick Current 2 starting profiles are selected by programming a digital input to the Ramp Select function and then energizing that input by applying 120 Volts to it. When a digital input is programmed to Ramp Select, but de-energized, Current Ramp 1 and Kick Current 1 are selected. When no digital inputs are programmed to the Ramp Select function the Ramp 1 profile is used.

The Ramp Select input only affects the starting profile when using a current ramp profile and during a kick. The Ramp Select input does not affect the TruTorque ramp, Power ramp, or the Voltage ramp profile (unless kicking is enabled at the beginning of those ramps).

The following table summarizes which parameters affect the starting profile when a digital input is programmed to the Ramp Select function and that input is either energized or de-energized.

Ramp Modes

	Ramp Select De-energized	Ramp Select Energized
Current Ramp	Initial Current 1	Initial Current 2
	Maximum Current 1	Maximum Current 2
	Ramp Time 1	Ramp Time 2
	Kick Level 1	Kick Level 2
	Kick Time 1	Kick Time 2
TruTorque Ramp	Initial Voltage/Torque/Power	
	Maximum Torque/Power	
	Ramp Time 1	
	Kick Level 1	Kick Level 2
	Kick Time 1	Kick Time 2
Power (KW) Ramp	Initial Voltage/Torque/Power	
	Maximum Torque/Power	
	Ramp Time 1	
	Kick Level 1	Kick Level 2
	Kick Time 1	Kick Time 2
Voltage Ramp	Initial Voltage/Torque/Power	
	Ramp Time 1	
	Kick Level 1	Kick Level 2
	Kick Time 1	Kick Time 2

7 - THEORY OF OPERATION

Changing Ramp Profiles

The selected ramp profile may be changed during starting by changing the Ramp Select input. When the Ramp Select input changes during ramping, control switches to the other profile as if it were already in progress. It does not switch to the beginning of the other profile. Refer to the following example below:

⚠ **NOTE:** Once the motor has achieved an up-to-speed status (UTS), changes to the Ramp Select input have no effect on the motor operation.

Figure 34: Changing Ramps During Acceleration Example

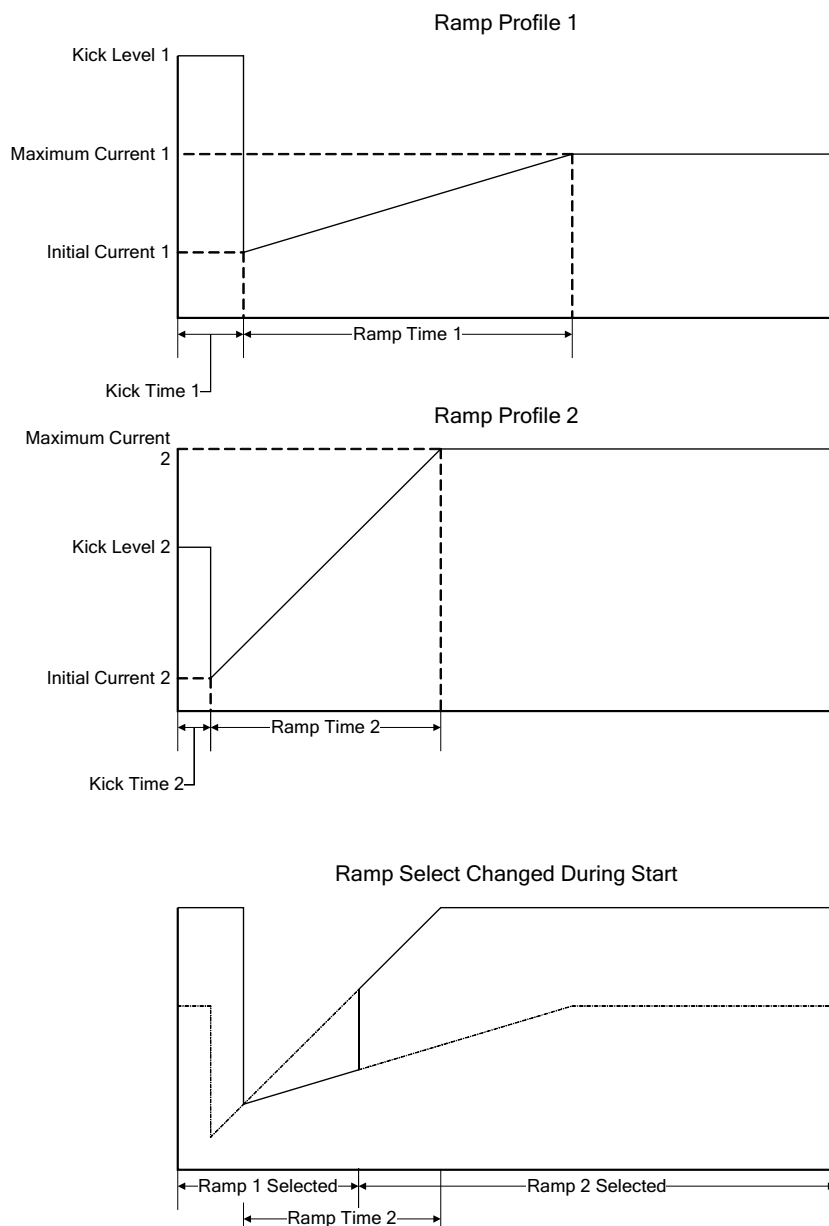

Deceleration Control

7.4 Deceleration Control

7.4.1 Voltage Control Deceleration

Overview

The deceleration control on the MX² uses an open loop voltage ramp. The MX² ramps the voltage down to decelerate the motor. The curve shows the motor voltage versus the decel setting.

Figure 35: Motor Voltage Versus Decel Level

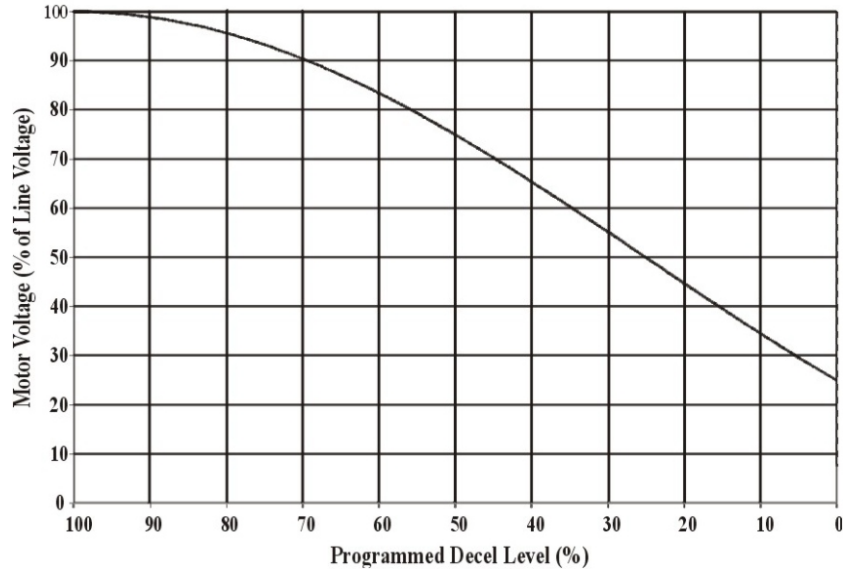

Beginning Level

This sets the starting voltage of the deceleration ramp. Most motors require the voltage to drop to around 60% or lower before any significant deceleration is observed. Therefore, a good first setting for this parameter is 35%.

To adjust this parameter, it is necessary to observe the motor operation as soon as a stop is commanded. If the motor hunts (speed oscillations) at the beginning of the deceleration, then lower the parameter by 5%. If the motor has a big drop in speed as soon as a stop is commanded, then raise the parameter by 5%.

Some motors are very sensitive to the adjustment of this parameter. If a 5% adjustment changes the motor from hunting to dropping in speed, then a smaller change of 1% or 2% may be necessary.

Ending Level

This sets the final voltage for the deceleration ramp. In most cases, this parameter can be set to 10% and the decel time can be used to adjust the deceleration rate. If the motor is coming to a stop too quickly or if the starter continues to apply current to the motor after the motor has stopped, this parameter can be increased in 5% increments to fix this.

Decel Time

The decel time sets how quickly the motor decelerates. Usually a time of 30 seconds is a good starting point. To make the motor take longer to decelerate, increase this parameter or to make the motor decelerate quicker, decrease this parameter.

⚠ **NOTE:** Deceleration control provides a smoother stop. However, the motor will take longer to stop than if it was just allowed to coast to stop.

7 - THEORY OF OPERATION

7.4.2 TruTorque Deceleration

Overview

TruTorque deceleration control is a closed loop deceleration control. This allows TruTorque deceleration to be more consistent in cases of changing line voltage levels and varying motor load conditions. TruTorque deceleration is best suited to pumping and compressor applications where pressure surges, such as water hammer, must be eliminated. The MX^2 linearly reduces the motor's torque to smoothly decelerate the motor and load. TruTorque deceleration is very easy to use with only two parameters to set.

Figure 36: TruTorque Deceleration

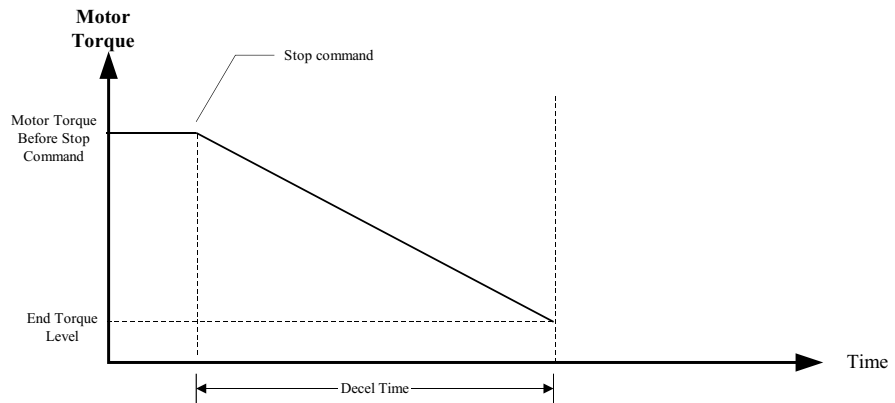

Ending Level

The Decel End Level parameter sets the ending torque level for the TruTorque deceleration ramp profile.

A typical TruTorque decel end level setting is between 10% and 20%. If the motor stops rotating before the deceleration time has expired, increase this parameter value. If the motor is still rotating when the deceleration time has expired, decrease this parameter value.

Decel Time

The decel time sets the ramp time between the motor torque level when stop was commanded and the decel end torque level.

If the motor stops rotating before the decel time has expired, decrease the decel time parameter. If the motor is still rotating when the decel time expires, increase the decel time parameter.

Braking Controls

7.5 Braking Controls

Overview

When the Stop Mode parameter is set to DC Brake, the MX² starter provides DC injection braking for fast and frictionless braking of a three-phase motor. The MX² starter applies a controlled DC current to the motor in order to induce a stationary magnetic field that then exerts a braking torque on the motor's rotating rotor. The braking current level and braking time required depends on the motor characteristics, the load inertia, and the friction in the system.

The MX² starter supports two different levels of DC injection braking:

1. Standard Duty Brake - For less than 6 x motor inertia.
2. Heavy Duty Brake - For NEMA specified inertia and two motor current feedback methods:
 - a) Standard Current Transformers (CTs)
 - b) Optional Hall Effect Current Sensor (LEM)

The optional Hall Effect Current sensor can be used when a more precise measurement of braking current is necessary. This can occur if the DC injection braking is applied when the source supply has a very high short circuit capability (very stiff) or in special instances when more precise braking current control is required. The appropriate brake type and feedback method is preset from the factory. Please consult Benschaw for more information if changes need to be made.

Maximum Load Inertia

The following table shows maximum load inertia, NEMA MG1 parts 12 and 20. A thermostat, thermistor or RTD MUST be installed to protect the motor from overheating.

HP	Speed - RPM						
	3600	1800	1200	900	720	600	514
	Inertia (lb-ft ²)						
2	2.4	11	30	60	102	158	228
3	3.5	17	44	87	149	231	335
5	5.7	27	71	142	242	375	544
7 1/2	8.3	39	104	208	356	551	798
10	11	51	137	273	467	723	1048
15	16	75	200	400	685	1061	1538
20	21	99	262	525	898	1393	2018
25	26	122	324	647	1108	1719	2491
30	31	144	384	769	1316	2042	2959
40	40	189	503	1007	1725	2677	3881
50	49	232	620	1241	2127	3302	4788
60	58	275	735	1473	2524	3819	5680
75	71	338	904	1814	3111	4831	7010
100	92	441	1181	2372	4070	6320	9180
125	113	542	1452	2919	5010	7790	11310
150	133	640	1719	3456	5940	9230	-
200	172	831	2238	4508	7750	12060	-
250	210	1017	2744	5540	9530	14830	-
300	246	1197	3239	6540	11270	-	-
350	281	1373	3723	7530	-	-	-
400	315	1546	4199	8500	-	-	-
450	349	1714	4666	9460	-	-	-
500	381	1880	5130	-	-	-	-
600	443	2202	6030	-	-	-	-
700	503	2514	-	-	-	-	-
800	560	2815	-	-	-	-	-

7 - THEORY OF OPERATION

7.5.1 DC Injection Braking, Standard Duty

The MX² Standard Duty Braking allows up to approximately 250% FLA current to be applied to the motor. The MX² Standard Duty package consists of an extra braking contactor that shorts Motor Terminals 2 & 3 together while braking, as DC current is applied by the MX² starter to provide moderate braking torque.

CAUTION: Contactor MUST NOT short phase T1 and phase T3.

⌘ **NOTE:** Contactor sizing requires AC1 contactor rating (Motor FLA / 1.6). The three contacts must be paralleled.

7.5.2 DC Injection Braking, Heavy Duty

The MX² Heavy Duty Braking allows up to 400% FLA current to be applied to the motor for maximum braking performance. The MX² Heavy Duty braking package includes a freewheel current path between phases 1 and 3 that consists of a fuse and a 7th SCR with gating card. In combination with the applied DC current from the MX² starter, the freewheeling current path greatly enhances available braking torque. When Braking, the stop must be counted as another motor start when looking at the motor starts per hour limit.

⌘ **NOTE:** Semi-Conductor Fuse and 7th SCR supplied by Benschaw.

7.5.3 Braking Output Relay

To utilize DC injection braking, one of the user output Relays needs to be programmed as a Braking relay. (Refer to the Relay Output Configuration parameters on page 112 for more information). The output of a Braking relay is needed to control the contactor and/or 7th SCR gating control card used during braking.

⌘ **NOTE:** Verify that the correct output relay is programmed to Braking and that the wiring of this relay is correct. Damage to the starter can result if the braking relay is not programmed and/or wired properly.

7.5.4 Stand Alone Overload Relay for emergency ATL (Across The Line) operation

Due to the currents being drawn on Line 1 and Line 3 for braking, this stand alone overload relay will cause nuisance current imbalance trips. For a solution consult factory.

7.5.5 DC Injection Brake Wiring Example

Figure 37: DC Injection Brake Wiring Example

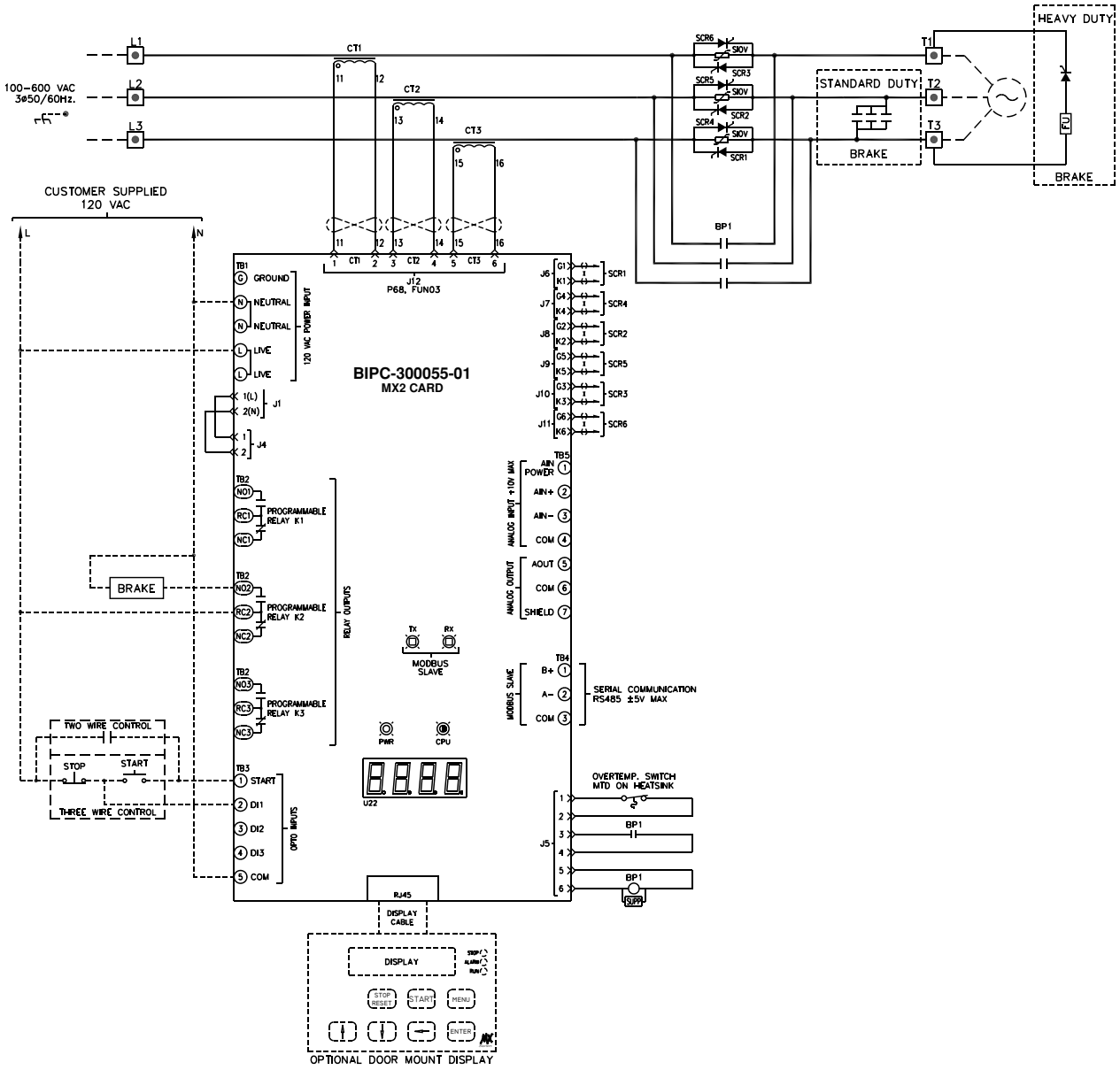

7 - THEORY OF OPERATION

7.5.6 DC Brake Timing

The MX² DC injection brake timing is shown below:

Figure 38: DC Injection Brake Timing

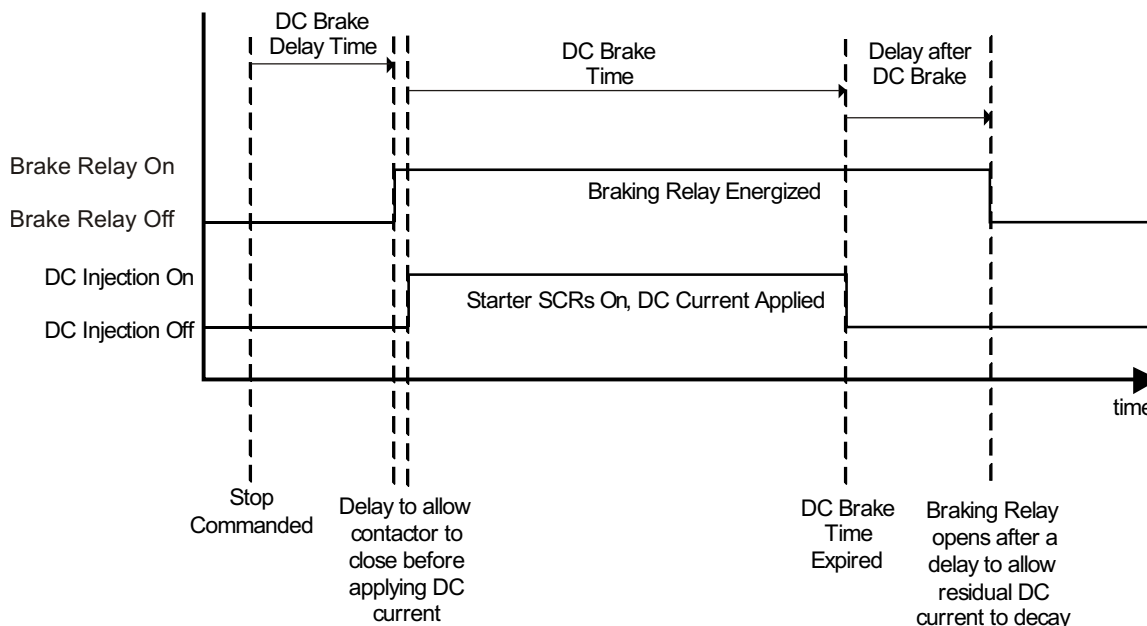

After the DC Brake Time has expired, the Braking Relay is held energized to allow the DC current to decay before opening the freewheel path. This delay prevents a contactor (if used) from having to open significant DC current which greatly prolongs the life of the contactor. This delay time is based on motor FLA, the larger the motor the longer the delay time. The delay after DC brake time is approximately:

Motor FLA	Delay after DC Brake Time
10 A	0.4 seconds
100 A	0.8 seconds
500 A	2.3 seconds
1000 A	4.3 seconds

Motor Overload Calculations During DC Injection Braking

During DC braking the MX² Solid State Motor Overload Protection is fully active. During braking the Running Motor Overload setting is used. The MX² adjusts the overload calculations based on whether Standard Duty or Heavy Duty braking is used. The overload calculations are also adjusted based on whether the standard Current Transformers (CTs) are used for current feedback or if the optional Hall Effect Current sensor is used for current feedback.

⚠ **NOTE:** Discretion must be used when DC injection braking. Motor heating during DC injection braking is similar to motor heating during starting. Although the Motor OL is active (if it has not been intentionally disabled), excessive rotor heating could still result if the load inertia is very large, braking level is high, or the brake time is set too long. Caution must be used to assure that the motor has the thermal capacity to brake the desired load in the desired period of time without excessive heating.

7 - THEORY OF OPERATION

7.5.7 DC Injection Brake Enable and Disable Digital Inputs

Digital inputs can be programmed to either a Brake Enable or a Brake Disable. In the Brake Enable case the digital input must be energized for DC braking to occur. The braking will immediately stop if the brake enable is de-energized.

In the Brake Disable case, DC braking will occur unless the Brake Disable digital input is energized. DC braking will cease if the brake disable is energized. Once DC Braking is stopped due to a digital input state change, no further DC braking will take place and the starter will return to the idle state.

7.5.8 Use of Optional Hall Effect Current Sensor

The Hall Effect Current Sensor should be located on Phase 1 of the motor output wiring. The sensor should be located so that the sensor measures both the applied DC current from the starter as well as the freewheel current. The sensor is connected to the analog input of the MX² card along with a burden resistor. The analog input must be set to be a 0-10V voltage input for correct operation. The sensor scaling and burden resistance are factory selected. Please consult factory if changes to either the sensor scaling or burden resistance is required.

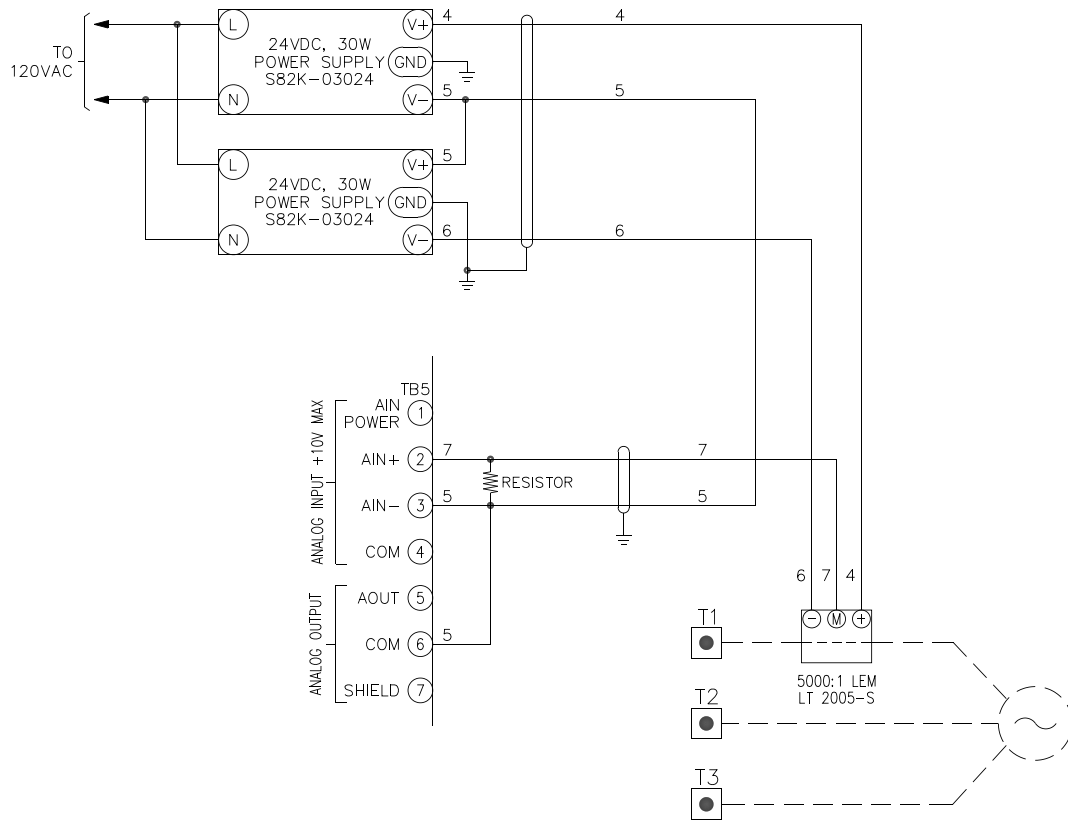

⚠ **NOTE:** Hall effect current sensor must be used when load inertia exceeds motor manufactures recommended specifications.

7 - THEORY OF OPERATION

7.5.9 DC Injection Braking Parameters

- Brake Level:** The DC Brake Level parameter sets the level of DC current applied to the motor during braking. The desired brake level is determined by the combination of the system inertia, system friction, and the desired braking time. If the motor is braking too fast the level should be reduced. If the motor is not braking fast enough the level should be increased.
- Brake Time:** The DC Brake Time parameter sets the time that DC current is applied to the motor. The desired brake time is determined by the combination of the system inertia, system friction, and the desired braking level. If the motor is still rotating faster than desired at the end of the brake time increase the brake time if possible. If the motor stops before the desired brake time has expired decrease the brake time to minimize unnecessary motor heating.
- Brake Delay:** The DC Brake Delay Time is the time delay between when a stop is commanded and the DC braking current is applied to the motor. This delay allows the residual magnetic field and motor counter EMF to decay before applying the DC braking current. If a large surge of current is detected when DC braking is first engaged increase the delay time. If the delay before the braking action begins is too long then decrease the delay time. In general, low horsepower motors can utilize shorter delays while large horsepower motor may require longer delays.

Slow Speed Cyclo Converter

7.6 Slow Speed Cyclo Converter

The MX² Soft Starter implements a patented Slow Speed algorithm that can be used to rotate a three-phase AC motor, with control of the stator current, at speeds less than the rated synchronous speed of the motor. The algorithm is used with a standard three-phase six-switch SCR based soft starter. The advantages of the MX² starter algorithm over other "jogging" techniques are that: the low speed motor rotation is done without any additional hardware such as additional mechanical contactors and/or extra SCRs, the peak phase currents are reduced compared with other jogging techniques, motor heating is minimized, and higher shaft torque can be generated.

7.6.1 Operation

Slow speed forward and reverse operation is achieved by energizing a digital input that has been programmed to either Slow Speed Forward or Slow Speed Reverse (refer to the Digital Input Configuration parameters on page 110 for more information). The active Control Source (local or remote source) must be set to terminal. Slow Speed Start/Stop control is not available from the optional LCD keypad. The starter must be in the idle state in order to enter slow speed operation.

Relay outputs can be programmed to energize during slow speed operation (refer to the Relay Output Configuration parameters on page 112 for more information). This feature can be used to disable mechanical brakes or energize clutches during slow speed operation.

Motor Overload Calculations During Slow Speed Operation

During Slow Speed Operation the MX² Solid State Motor Overload Protection is fully active. During slow speed operation the Running Motor overload setting is used.

⚠ **NOTE:** When the motor is operating at slow speeds its cooling capacity can be greatly reduced. Therefore the running time of the motor at a given current level is dependant on the motor's thermal capacity. Although the Motor OL is active (if it has not been intentionally disabled) during slow speed operation it is recommended that the motor temperature be monitored if slow speed is used for long periods of time.

⚠ **NOTE:** For Continuous Slow Speed Operation, an RC2 is required.

7.6.2 Slow Speed Cyclo Converter Parameters

- Slow Speed:** The Slow Speed parameter selects the speed of motor operation when slow speed is selected. When set to Off, slow speed operation is disabled.
- Slow Speed Current Level:** The Slow Speed Current Level parameter selects the level of current applied to the motor during slow speed operation. The parameter is set as a percentage of motor full load amps (FLA). This value should be set to the lowest possible current level that will properly operate the motor.
- Slow Speed Time Limit:** The Slow Speed Time Limits parameter sets the amount of time that continuous operation of slow speed may take place. When this parameter is set to OFF the timer is disabled. This parameter can be used to limit the amount of continuous slow speed operation to protect the motor and/or load.
- ⌘ **NOTE:** The Slow Speed Time Limit includes the time used for the Slow Speed Kick if kick is enabled.
- ⌘ **NOTE:** The Slow Speed Time Limit resets when the motor is stopped. This timer does not prevent the operator from stopping and re-starting the motor which can result in the slow speed operation time of the motor being exceeded.
- Slow Speed Kick Level:** The Slow Speed Kick Level sets the short-term current level that is applied to the motor to accelerate the motor for slow speed operation. The Slow Speed Kick feature is disabled if it is set to off. Slow Speed Kick can be used to "break loose" difficult to start loads while keeping the operating slow speed current level lower.
- This parameter should be set to a midrange value and then the Slow Speed Kick Time should be increased in 0.1 second intervals until the kick is applied long enough to start the motor rotating. If the motor does not start rotating with the set Slow Speed Kick Level increase the level and begin adjusting the kick time from 1.0 seconds again.
- If the motor initially accelerates too fast then reduce the Slow Speed Kick Level and/or reduce the Slow Speed Kick Time.
- Slow Speed Kick Time:** The Slow Speed Kick Time parameter sets the length of time that the Slow Speed Kick current level is applied to the motor at the beginning of slow speed operation. After the Slow Speed Kick Level is set, the Slow Speed Kick Time should be adjusted so that the motor starts rotating when a slow speed command is given.
- If the motor initially accelerates too fast then reduce the Slow Speed Kick Level and/or reduce the Slow Speed Kick Time.

7 - THEORY OF OPERATION

Inside Delta Connected Starter

7.7 Inside Delta Connected Starter

There are differences between a line connected soft starter as shown in Figure 39 and the inside delta connected soft starter as shown in Figure 40 that need to be considered.

By observation of Figure 40, access to all six stator-winding terminals is required for an inside delta application. For a 12-lead motor, all 12 stator terminals must be accessible. In the line connected soft starter of Figure 39, access to only three leads of the stator windings of the motor is required.

One failed SCR on any phase of the inside delta soft starter results in a single-phase condition. A shunt trip circuit breaker is recommended to protect the motor in this case. A programmable relay can be configured as a shunt trip relay and can be used to trip the breaker. When certain faults occur, the shunt trip relay energizes.

The SCR control for an inside delta application is different than the SCR control for a standard soft starter. The Starter Type parameter needs to be properly set so that the SCRs are gated correctly.

If a circuit breaker is the only means to disconnect the soft starter and motor from the line, then one leg of the motor leads in the inside delta soft starter is always electrically live when the circuit breaker is closed. This requires caution to ensure these leads of the motor are not exposed to personnel.

7.7.1 Line Connected Soft Starter

In Figure 39, the power poles of the soft starter are connected in series with the line. The starter current equals the line current.

Figure 39: Typical Motor Connection

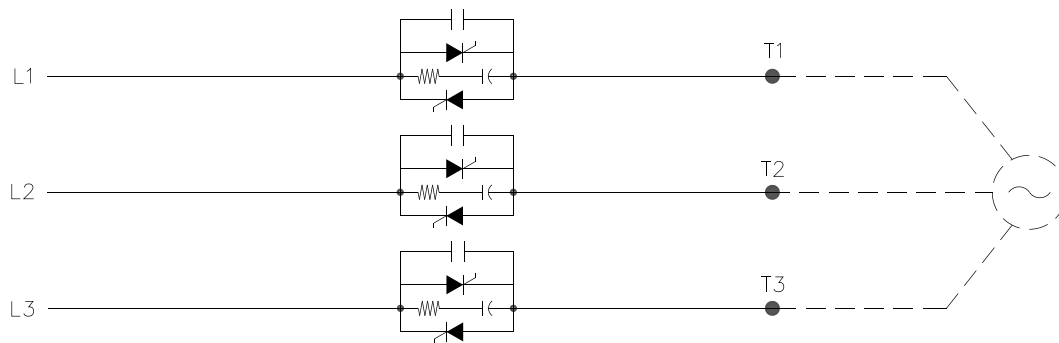

7.7.2 Inside Delta Connected Starter

An inside delta connected soft starter is shown in Figure 40, where the power poles are connected in series with the stator windings of a delta connected motor.

Figure 40: Typical Inside Delta Motor Connection

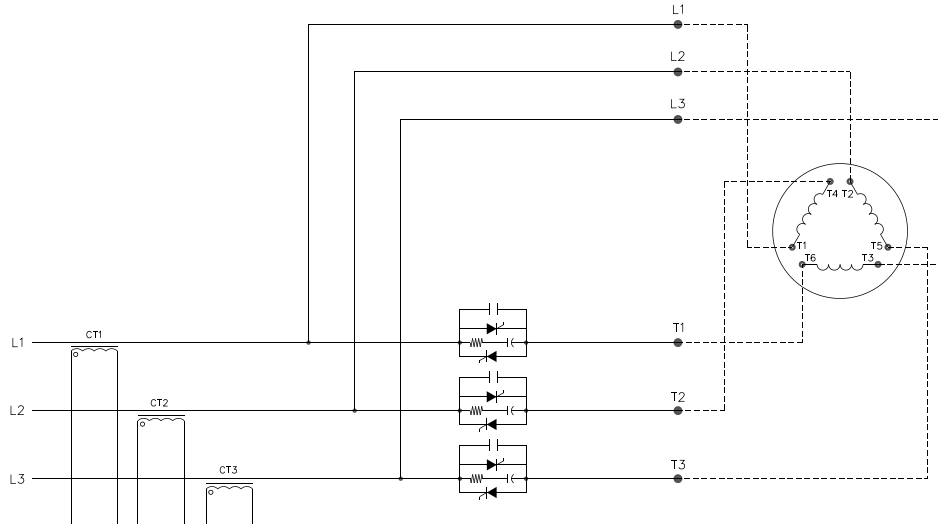

For an inside delta connected motor, the starter current is less than the line current by a factor of 1.55 (FLA/1.55). By comparison of Figure 39 and Figure 40, the most obvious advantage of the inside delta starter is the reduction of current seen by the soft starter. The soft starter can be downsized by a factor of 1.55, providing significant savings in cost and size of the starter.

An inside delta soft starter can also be considered for motors with more than 6 leads, including 12 lead dual voltage motors.

NEMA and IEC use different nomenclature for motor terminal markings, for 3 and 6 lead motors.

NEMA labels motor leads, 1,2,3,4,5,6,

IEC labels motor leads, U1, V1, W1, U2, V2, W2

7 - THEORY OF OPERATION

Wye Delta Starter

7.8 Wye Delta Starter

When the Starter Type parameter is set to Wye-Delta, the MX² is configured to operate an Electro mechanical Wye-Delta (Star-Delta) starter. When in Wye-Delta mode, all MX² motor and starter protective functions except bad SCR detection and power stack overload, are available to provide full motor and starter protection.

A typical closed transition Wye-Delta starter schematic is shown in the following figure.

Figure 41: Wye Delta Motor Connection to the MX²

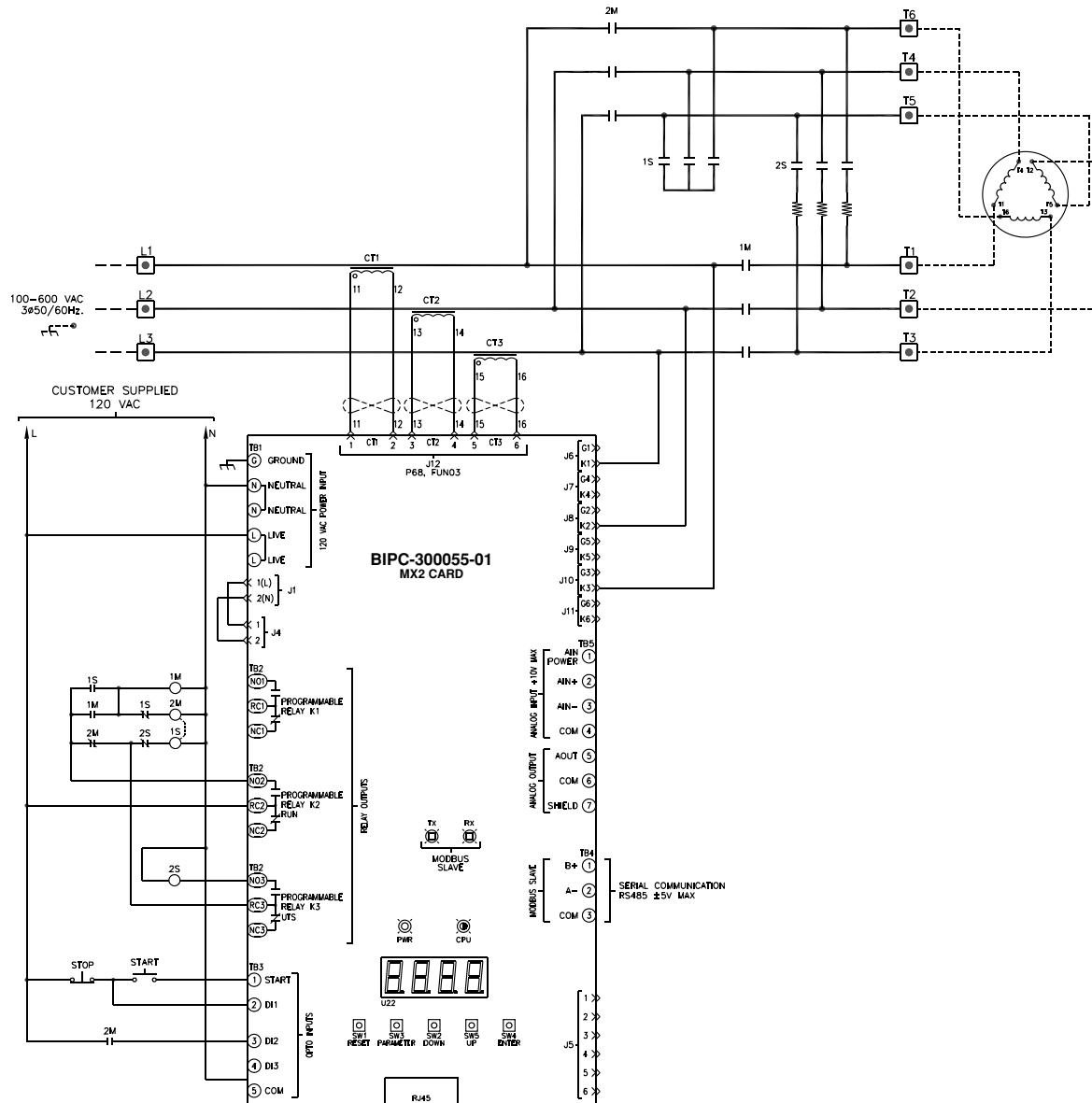

7 - THEORY OF OPERATION

The MX² utilizes an intelligent Wye to Delta transition algorithm. During starting, if the measured motor current drops below 85% of FLA and more than 25% of the Up To Speed timer setting has elapsed, then a Wye to Delta transition occurs. The intelligent transition algorithm prevents unnecessarily long motor starts which reduces motor heating. If a Wye to Delta transition has not already occurred, a transition always occurs when the complete Up To Speed Time expires.

The MX² can operate two configurations of Wye-Delta starters, open transition and closed transition. An open transition starter momentarily disconnects the motor from the input line during the transition from Wye to Delta operating mode. A closed transition starter uses resistors that are inserted during the transition so that the motor is never completely disconnected from the input line. The presence of the resistors in a closed transition starter smooths the transition. A typical closed transition Wye-Delta starter schematic is shown in Figure 41 on page 160.

The closed transition resistors generally are sized to be in the circuit for a short period of time. To protect the resistors from over heating, one input should be programmed as a Bypass/2M contact feedback input and the Bypass/2M confirm parameter must be set.

For the Wye-Delta starter mode to operate properly one output relay needs to be programmed to the RUN output function and another output relay needs to be programmed to the UTS output function. (Refer to the Relay Output Configuration parameters on page 112 for more information).

Based on the typical closed transition schematic shown in Figure 41, when a start command is given, the starter enters the Wye starting mode by energizing the relay programmed as RUN.

The transition to Wye (Starting) mode occurs as follows:

1. Start command is given to the starter.
2. The RUN relay is energized which energizes the 1S contactor.
3. When the 1S contactor pulls in, the 1M contactor is energized.

The MX² starter remains in the Wye mode until either:

1. The start command is removed.
2. The Up To Speed Time expires.
3. The measured motor current is less than 85% of FLA and more than 25% of the Up To Speed Timer setting has elapsed.
4. A fault occurs.

When the Up To Speed Time expires, the starter changes from Wye starting mode to the Delta or normal running mode by energizing the relay programmed as UTS. In Delta mode, the RUN and UTS relays are both energized and the motor is connected in the normal running Delta configuration.

The transition to Delta (Run) mode occurs as follows:

1. The UTS relay is energized which energizes the 2S contactor.
2. When the 2S contactor pulls in, resistors are inserted in the circuit and the 1S contactor is de-energized.
3. When the 1S contactor drops out the 2M contactor is energized.
4. When the 2M contactor is pulled in, feedback can be sent to the MX² control card to confirm that the transition sequence to Delta is complete.

The starter remains in the Delta or running mode until the start command is removed or a fault occurs.

7 - THEORY OF OPERATION

Usually the MX² intelligent Wye to Delta transition algorithm provides an optimal transition point that minimizes the transient current and torque surges that can occur. However, the Wye to Delta transition will occur when the Up To Speed Time parameter has expired. In order to reduce the current surge during the transition from Wye to Delta mode, the Up To Speed Time parameter should be adjusted so that the transition occurs as close to full speed as possible within the constraints of the load. If the Up To Speed Time is set too short, the starter will transition too soon and a large current and torque surge will occur. If the Up To Speed Time is set too long, the motor may not have sufficient torque to continue accelerating when in Wye mode and may stop accelerating at a low speed until the transition to Delta mode occurs. If this occurs, the start is unnecessarily prolonged and motor heating is increased.

A typical closed transition Wye-Delta starting current profile is shown in Figure 42.

Figure 42: Wye Delta Profile

Wye-Delta Closed Transition Current Profile

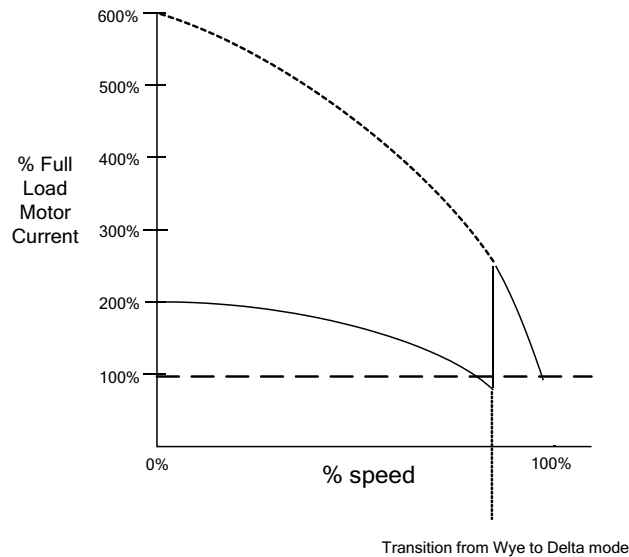

A digital input can be programmed as a 2M contactor feedback input. This input provides verification that the 2M contactor has fully closed preventing operation when the transition resistors are still connected in the motor circuit. The use of this feedback is recommended to prevent the overheating of the transition resistors if the 2M contactor does not close properly. The 2M confirmation trip time can be adjusted by modifying the Bypass Feedback Time parameter.

⌘ **NOTE:** When in Wye-Delta mode, the acceleration ramp, kick, and deceleration settings have no effect on motor operation.

⌘ **NOTE:** When in Wye-Delta mode, the SCR gate outputs are disabled.

Across The Line Starter

7.9 Across The Line (Full Voltage Starter)

When the Starter Type parameter is set to ATL, the MX² is configured to operate an Electro mechanical full voltage or across-the-line (ATL) starter.

In the ATL configuration, the MX² assumes that the motor contactor (1M) is directly controlled by an output relay that is programmed to RUN. Therefore, when a start command is given, the RUN programmed relay energizes the motor contactor, which applies power to the motor. When the MX² determines that the motor is at full speed, the up-to-speed (UTS) condition is indicated by energizing the UTS programmed relay. When configured as an ATL starter, all MX² motor and starter protective functions, except bad SCR detection and power stack overload, are available to provide full motor and starter protection.

Figure 43: A Typical ATL Starter Schematic with the MX²

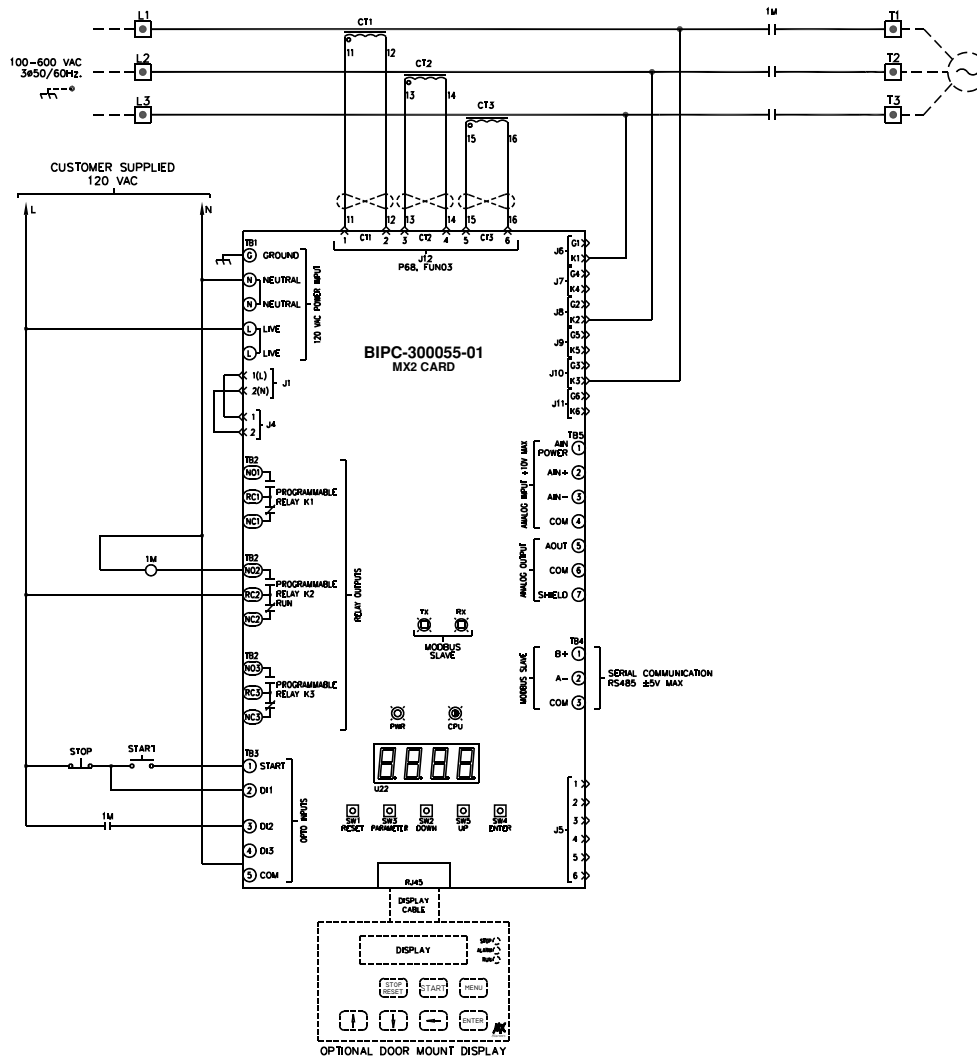

⌘ NOTE: When in ATL mode, the acceleration ramp, kick, and deceleration parameter settings have no effect on motor operation.

⌘ NOTE: When in ATL mode, the SCR gate outputs are disabled.

7 - THEORY OF OPERATION

Single Phase Soft Starter

7.10 Single Phase Soft Starter

There are times a single phase motor may need to be started using a soft starter. This can be accomplished with any 3 phase starter with the following modifications to the starter.

- Connect Line power to terminals L1 and L3.
- Remove gate leads from J8 and J9 and tie off so the leads will not touch anything
- Remove gate leads from J6 and reinstall to J8, from J7 and reinstall to J9
- Change Input Phase Sensitivity, (P77/FUN 04) to "SPH" Single Phase.
- Connect motor to terminals T1 and T3.

Figure 44: Power Schematic for RB2 Integral Bypass Power Stack for Single Phase Operation

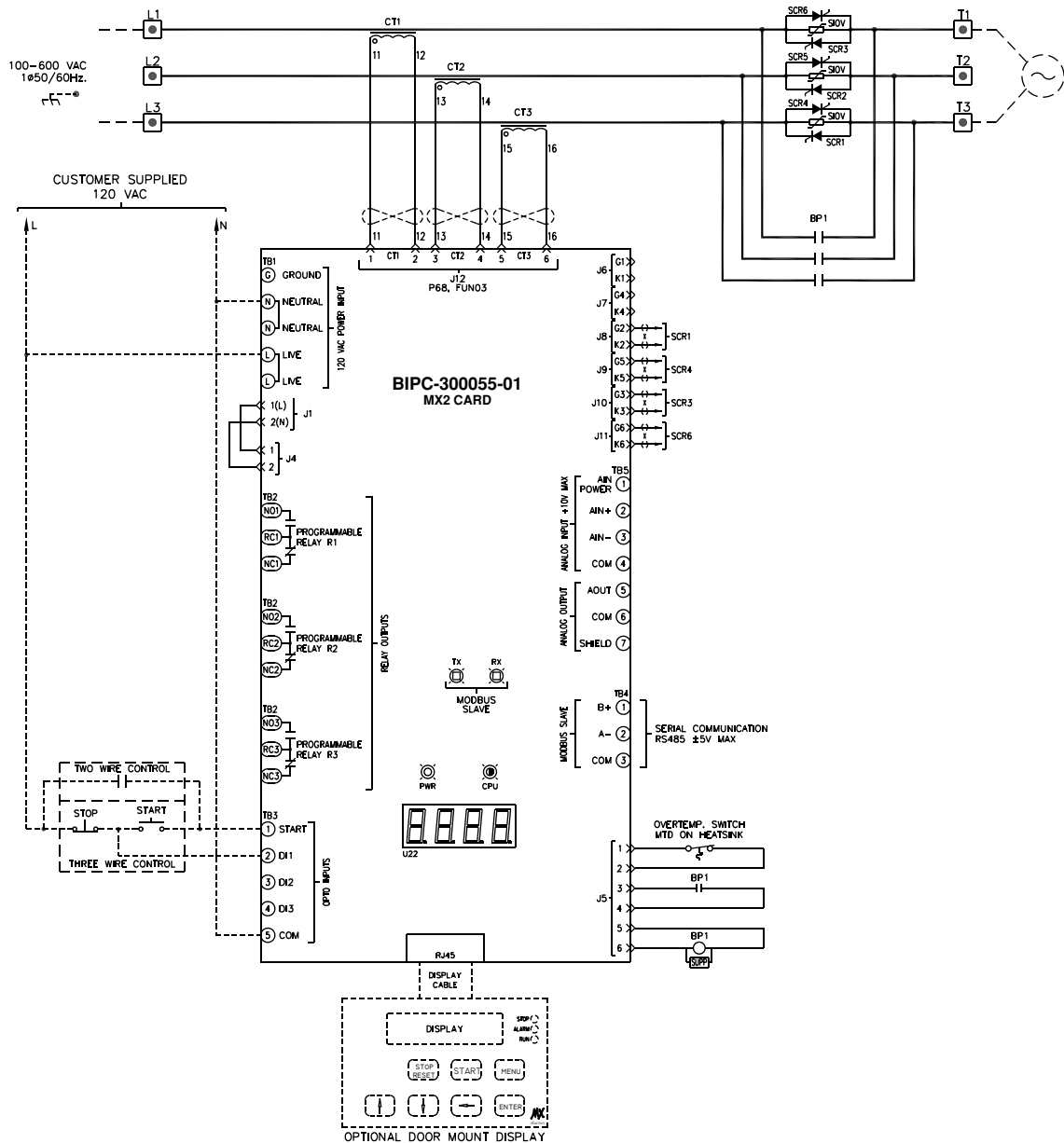

7.11 Phase Control

When the Starter Type parameter is set to Phase Control, the MX² is configured to operate as a phase controller or voltage follower. This is an open loop control mode. When a start command is given, the RUN programmed relays energize. The firing angles of the SCRs are directly controlled based on voltage or current applied to the Analog Input.

Phase control can be used to directly control the voltage applied to motors, resistive heaters, etc. When in Phase Control mode, the phase angle of the SCRs, and hence the voltage applied, is directly controlled based on the analog input signal. The MX² reference command can be generated from any 0-10V, 0-20mA or similar source, such as a potentiometer, another MX² or an external controller such as a PLC.

Figure 45: Phase Control Mode

Output Voltage vs Analog Input

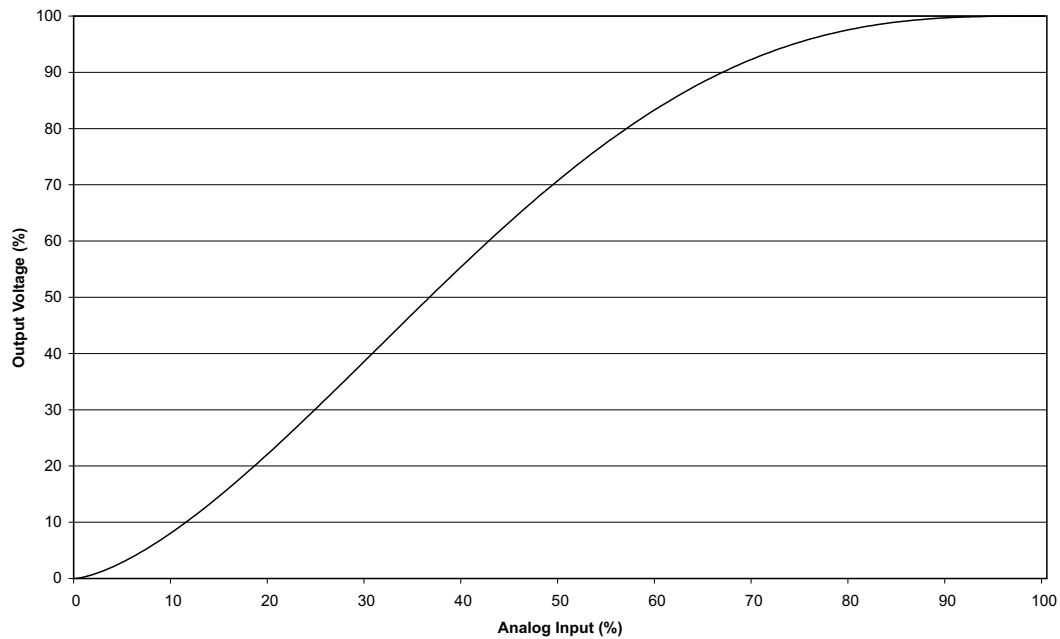

A reference input value of 0% results in no output. A reference input value of 100% results in full (100%) output voltage. The actual input voltage / current that results in a given output can be adjusted through the use of the Analog Input Offset and the Analog Input Span parameters.

⌘ NOTE: The power stack must be rated for continuous non-bypassed duty in order to operate in Phase Control mode continuously, **NO BYPASS**.

⌘ NOTE: When operating in Phase Control mode, the acceleration ramp, kick, and deceleration settings have no effect on operation.

⌘ NOTE: When in Phase Control mode the following motor / starter protective functions are available:

- Current Imbalance
- Over Current
- Current while Stopped
- Under Current
- Over Voltage
- Under Voltage
- Motor OL
- Residual Ground Fault
- Instantaneous Over Current (IOC)
- Phase Rotation
- Phase Loss
- Under Frequency
- Over Frequency

7 - THEORY OF OPERATION

7.11.1 Master/Slave Starter Configuration:

In the master / slave configuration, one "master" starter can directly control the output of one or more "slave" starters. To utilize the master / slave configuration, one starter needs to be defined as the "master" starter. The Starter Type parameter of the "master" starter should be configured appropriately as a Soft Starter (normal or ID), Phase Controller or Current Follower. If configured as a soft starter, the acceleration and deceleration profiles need to be configured for proper operation.

To configure a master / slave application:

1. The analog output of the master MX² control card needs to be connected to the analog input(s) of the slave card(s).
2. The master MX²'s analog output needs to be configured. Set the Analog Output Function parameter to option 10 or "0 - 100% firing". The Analog Output Span parameter should be set to provide a 0-10V or 0-20 milliamp output to the slave starter(s). Adjust analog output jumper (JP1) to provide either a voltage or a current output. Set the slave MX²'s Starter Type parameter to Phase Control and verify that the Analog Input Offset and Analog Input Span parameters are set to accept the master signal.
3. The slave MX² needs to be provided with a start command from the master MX². A RUN programmed relay from the master MX² can be used to provide the start command to the slaves. The slave(s) Control Source parameters (Local Source and Remote Source) settings need to be set appropriately.
4. The slave MX² analog input(s) needs to be configured for the appropriate voltage or current input signal type. Set the analog input jumper (SWI-1) to the desired input type.

For additional master/slave application information, consult the factory.

Current Follower

7.12 Current Follower

When the Starter Type parameter is set to Current Follower, the MX² is configured to operate as a Closed Loop current follower. Current Follower mode can be used to control the current applied to motors, resistive heaters, etc. The Current Follower mode uses the analog input to receive the desired current command and controls the SCRs to output the commanded current. The MX's reference command can be generated from any 0-10V, 0-20mA or 4-20mA source such as a potentiometer, another MX² or an external controller such as a PLC.

Figure 46: Current Follower Mode

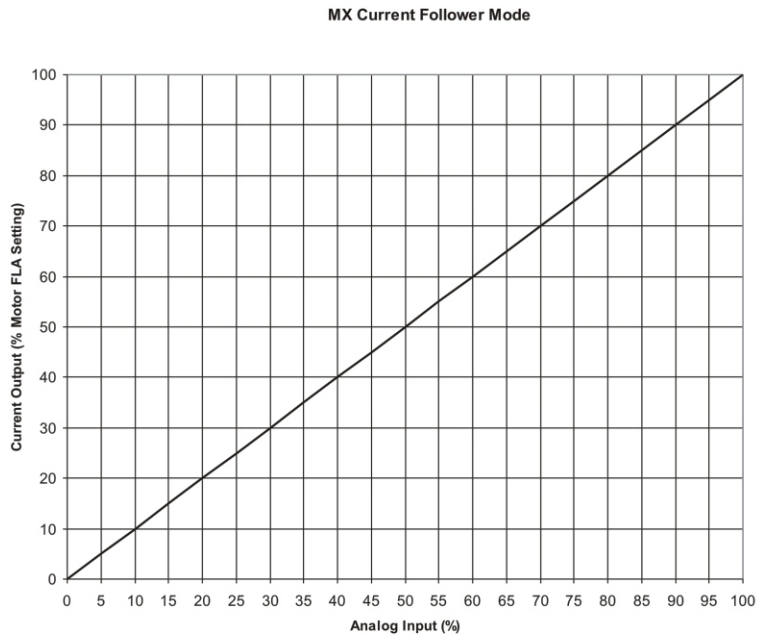

A reference input value of 0% results in no output. A reference input value of 100% results in a current output equal to the Motor FLA setting. The actual voltage or current input that results in a given output can be adjusted through the use of the Analog Input Offset and Analog Input Span parameters.

⚠ **NOTE:** The power stack must be rated for continuous non-bypassed duty in order to operate in Current Follower mode.

⚠ **NOTE:** When operating in Current Follower mode, the acceleration ramp, kick, and deceleration settings have no effect on operation.

⚠ **NOTE:** The following motor / starter protective functions are available when in Current Follower mode:

- Current Imbalance
- Over Current
- Under Current
- Over Voltage
- Under Voltage
- Over Frequency
- Under Frequency
- Phase Loss
- Phase Rotation
- Current while Stopped
- Motor OL
- Residual Ground Fault
- Instantaneous Over Current (IOC)

Start/Stop Control with a Hand/Off/Auto Selector Switch

7.13 Start/Stop Control Logic

Often times, a switch is desired to select between local or “Hand” mode and remote or “Auto” mode. In most cases, local control is performed as 3-wire logic with a normally open, momentary contact Start pushbutton and a normally closed, momentary contact Stop pushbutton, while remote control is performed as 2-wire logic with a “Run Command” contact provided by a PLC.

The MX² can perform both 2-wire start/stop logic and 3-wire start/stop logic. With 2-wire logic, the starter starts when a run command is applied to the Start input. It continues to run until the run command is removed from the Start input. With 3-wire logic, the starter starts when a start command is momentarily applied to the Start input and continues to run until an input programmed as a Stop input goes low.

The MX² automatically determines whether to use 2-wire logic or 3-wire logic by the presence of a high level on a Stop input. If there is an input programmed as a Stop input, and that input is high when the Start input goes high, then 3-wire start/stop logic is used. Otherwise, 2-wire start/stop logic is used. This feature eliminates the need for external logic relays often used to “seal in” the momentary Start and Stop pushbuttons, creating a 2-wire logic signal. The key is to have the Stop input be high when the Hand/Off/Auto switch is in the Hand position, but be low when the switch is in the Auto position.

CAUTION: It is important that the Stop push button be wired in front of the Start push button, otherwise the starter could be started when the Stop bush button is pressed and the Start button is pressed.

7.14 Hand/Off/Auto Selector Switch

The MX2 has the capability to use a selector switch to change the source of control. A popular use is to switch between using the door mounted display for Hand operation and using contact input for Auto operation. The following drawing shows how to wire the unit to allow this operation.

Figure 47: Example of Start/Stop with a Hand/Off/Auto Selector Switch

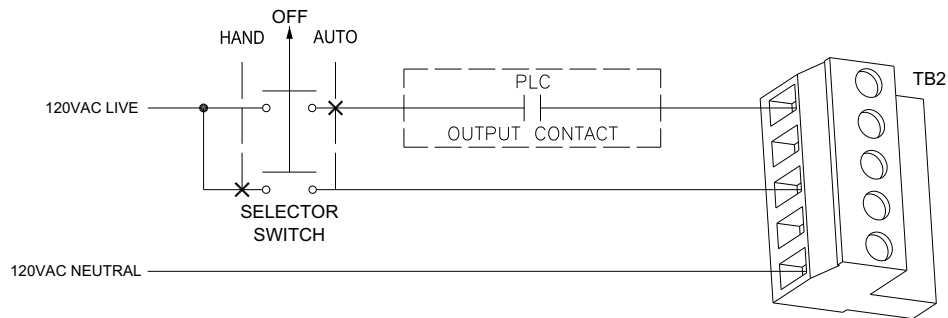

The following parameters have to be programmed into the starter:

P4: Local Source = Terminal

P5: Remote Source = Keypad

P49: DI2 Configuration = Local/Remote

Hand Position

The starter is switched to use the Remote Source via the selector switch which applies 120VAC to digital input 2. The Remote Source is programmed to Keypad so the keypad becomes active in this switch position.

Off Position

The starter is switched to use the Local Source via the selector switch which removes 120VAC from digital input 2. The Local Source is programmed to Terminal so the Start digital input becomes active in the switch position. However, the selector switch also disconnects control power from customer run contact so that 120VAC can not be applied to the Start digital input meaning the starter cannot be given a start command.

Auto Position

The starter is switched to use the Local Source via the selector switch which removes 120VAC from digital input 2. The Local Source is programmed to Terminal so the Start digital input becomes active in this switch position. The selector switch also connects control power to the customer run contact so that a start can be applied.

7.15 Simplified I/O Schematics

Figure 48: Digital Input Simplified Schematic

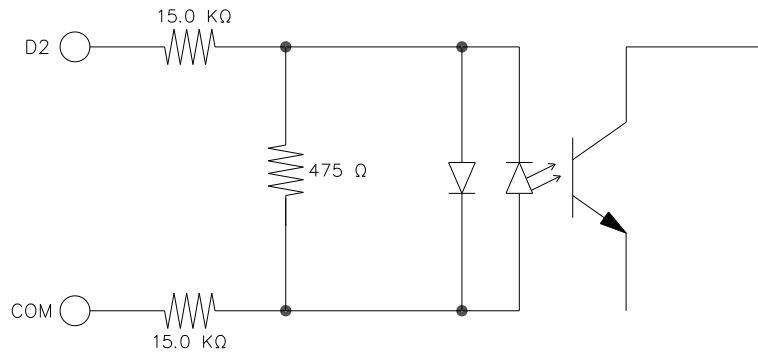

Figure 49: Analog Input Simplified Schematic

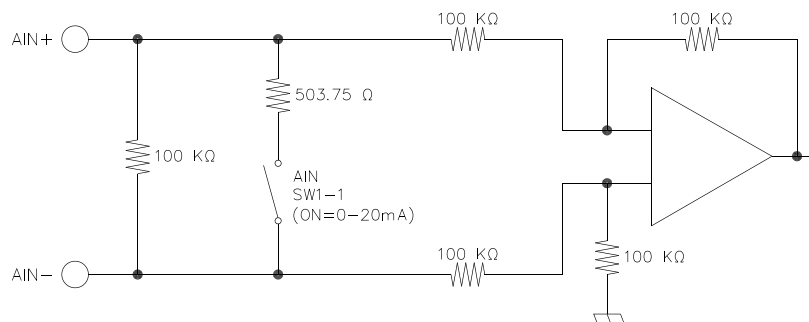
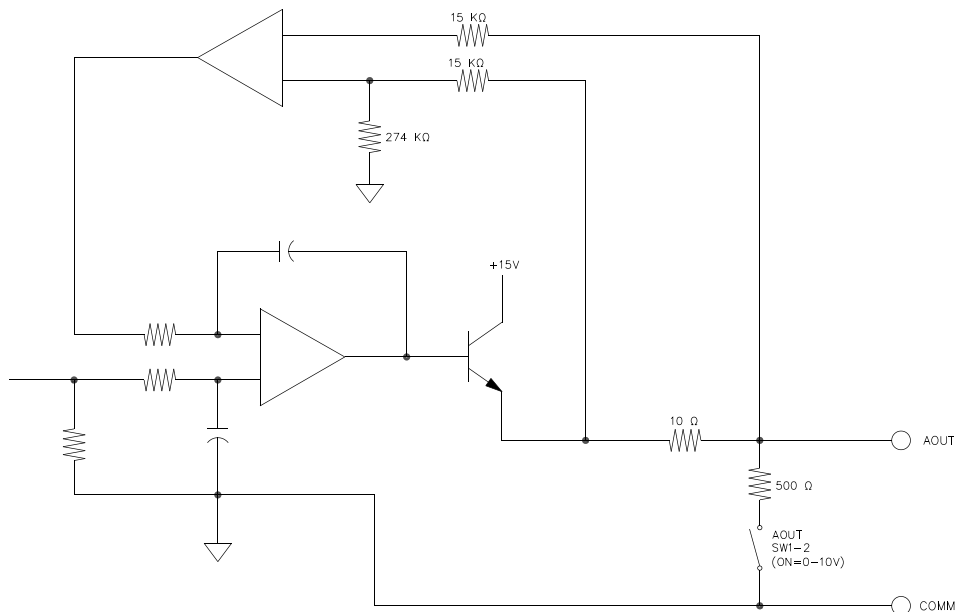
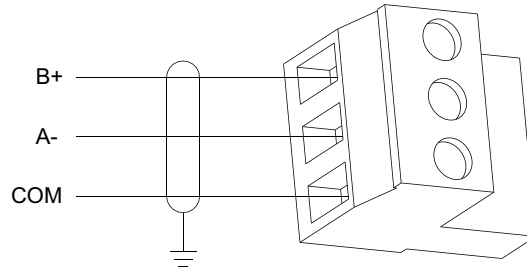

Figure 50: Analog Output Simplified Schematic



Remote Modbus Communications

Figure 49: TB4 Connector



7.16 Remote Modbus Communications

The MX² starter provides a Modbus RTU to support remote communication.

The communication interface is RS-485, and allows up to 247 slaves to be connected to one master (with repeaters when the number of drops exceeds 31). Please refer to Figures 49 and 50 for connection diagrams.

7.16.1 Supported Commands

The MX² supports the following Modbus commands:

- Read Holding Registers (03 hex)
- Read Input Registers (04 hex)
- Preset Single Register (06 hex)
- Preset Multiple Registers (10 hex)

Up to 64 registers may be read or written with a single command.

7.16.2 Modbus Register Addresses

The Modbus specification defines holding registers to begin at 40001 and input registers to begin at 30001. Holding registers may be read and written. Input registers may only be read.

In the MX², the register maps are identical for both the holding registers and the input registers. For example, the Motor FLA parameter is available both in holding register 40101 and in input register 30101. This is why the register addresses in the Modbus Register Map are listed with both numbers (e.g. 30101/40101).

7.16.3 Cable Specifications

Good quality twisted, shielded communications cable should be used when connecting to the Modbus port on the MX². The cable should contain two twisted pairs and have an overall shield. Use one pair of conductors for the A(-) and B(+) signals. Use the other pair of conductors for the Common signal. The cable should adhere to the following specifications.

- Conductors: 2 twisted pair
- Impedance: 100 Ohm to 120 Ohm
- Capacitance: 16 pF/ft or less
- Shield: Overall shield or individual pair shields

Examples of cables that meet these specifications are Belden part number 9842 and Alpha Wire part number 6412.

7 - THEORY OF OPERATION

7.16.4

Figure 50: Modbus Network Wiring Example

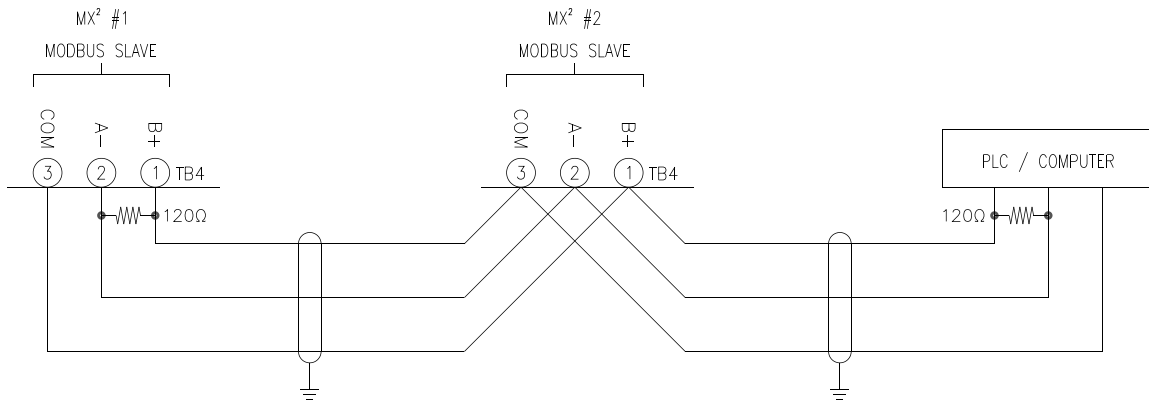

! IMPORTANT

DO NOT CREATE STUBS - CABLE MUST GO TO EACH STARTER.

Right

Wrong

8

Troubleshooting & Maintenance

8 - TROUBLESHOOTING & MAINTENANCE

Safety Precautions

8.1 Safety Precautions

For safety of maintenance personal as well as others who might be exposed to electrical hazards associated with maintenance activities, the safety related work practices of NFPA 70E, Part II, should always be followed when working on electrical equipment. Maintenance personnel must be trained in the safety practices, procedures, and requirements that pertain to their respective job assignments.



WARNING: To avoid shock hazard, disconnect main power before working on controller/starter, motor or control devices such as start/stop pushbuttons. Procedures which require parts of the equipment to be energized during troubleshooting, testing, etc. must be performed by properly qualified personnel, using appropriate work practices and precautionary measures as specified in NFPA70, Part II.



CAUTION: Disconnect the controller/starter from the motor before measuring insulation resistance (IR) of the motor windings. Voltages used for insulation resistance testing can cause failure of SCR's. Do not make any measurements on the controller with an IR tester (megger).

Preventative Maintenance

8.2 Preventative Maintenance

8.2.1 General Information

Preventative maintenance performed on a regular basis will help ensure that the starter continues to operate reliably and safely. The frequency of preventative maintenance depends upon the type of maintenance and the installation site's environment.

⌘ **NOTE:** A trained technician should always perform preventative maintenance.

8.2.2 Preventative Maintenance

During Commissioning:

- Torque all power connections during commissioning. This includes factory wired equipment.
- Check all of the control wiring in the package for loose connections.
- If fans are installed, ensure proper operation

One month after the starter has been put in operation:

- Re-torque all power connections. This includes factory wired equipment.
- Inspect the cooling fans to ensure proper operation.

After the first month of operation:

- Re-torque all power connections every year.
- Clean any accumulated dust from the starter using a clean source of compressed air.
- Inspect the cooling fans every three months to ensure proper operation.
- Clean or replace any air vent filters on the starter every three months.

⌘ **NOTE:** If mechanical vibrations are present at the installation site, inspect the electrical connections more frequently.

8 - TROUBLESHOOTING & MAINTENANCE

General Troubleshooting Charts

8.3 General Troubleshooting Charts

The following troubleshooting charts can be used to help solve many of the more common problems that may occur.

8.3.1 Motor does not start, no output to motor

Condition	Cause	Solution
Display Blank, CPU Heartbeat LED on MX ² board not blinking.	Control voltage absent.	Check for proper control voltage input. Verify fuses and wiring.
	MX ² control board problem.	Consult factory.
Fault Displayed.	Fault Occurred.	See fault code troubleshooting table for more details.
Start command given but nothing happens.	Start/Stop control input problems.	Verify that the start/stop wiring and start input voltage levels are correct.
	Control Source parameters (QST 04-05, P4-5) not set correctly.	Verify that the parameters are set correctly.
NOL or No Line is displayed and a start command is given, it will fault in F28.	No line voltage has been detected by the MX ² when a start command is given.	Check input supply for inline contactor, open disconnects, open fuses, open circuit breakers, or disconnected wiring.
		Verify that the SCR gate wires are properly connected to the MX ² control board.
		On medium voltage systems, verify wiring of the voltage feedback measurement circuit.
		See fault code troubleshooting table for more details.

8 - TROUBLESHOOTING & MAINTENANCE

8.3.2 During starting, motor rotates but does not reach full speed

Condition	Cause	Solution
Fault Displayed.	Fault Occurred.	See fault code troubleshooting table for more details.
Display shows Accel or Run.	Maximum Motor Current setting (P7/QST07) set too low.	Review acceleration ramp settings.
	Motor loading too high and/or current not dropping below 175% FLA indicating that the motor has not come up to speed.	Reduce load on motor during starting.
	Motor FLA (P1/QST01) or CT ratio (P78/FUN03) parameter set incorrectly.	Verify that Motor FLA and CT ratio parameters are set correctly.
	Abnormally low line voltage.	Fix cause of low line voltage.
	A mechanical or supplemental brake is still engaged.	Verify that any external brakes are disengaged.
Motor Hums before turning.	Initial current to low.	Increase initial current.
	FLA or CT incorrect..	Verify FLA and CT settings.

8.3.3 Starter not accelerating as desired

Condition	Cause	Solution
Motor accelerates too quickly.	Ramp time (P8/QST08) too short.	Increase ramp time.
	Initial current (P6/QST06) set too high.	Decrease Initial current.
	Maximum current (P7/QST07) set too high.	Decrease Maximum current.
	Kick start current (P13/CFN10) too high.	Decrease or turn off Kick current.
	Kick start time (P14/CFN11) too long.	Decrease Kick time.
	Motor FLA (P1/QST01) or CT ratio (P78/FUN03) parameter set incorrectly.	Verify that Motor FLA and CT ratio parameters are set correctly.
	Starter Type parameter (P64/FUN07) set incorrectly.	Verify that Starter Type parameter is set correctly.
Motor accelerates too slowly	Maximum Motor Current setting (P7/QST07) set too low.	Review acceleration ramp settings.
	Motor loading too high.	Reduce load on motor during starting.
	Motor FLA (P1/QST01) or CT ratio (P78/FUN03) parameter set incorrectly.	Verify that Motor FLA and CT ratio parameters are set correctly.
	Abnormally low line voltage.	Fix cause of low line voltage.
	Ramp time to long.	Decrease ramp time.

8 - TROUBLESHOOTING & MAINTENANCE

8.3.4 Starter not decelerating as desired

Condition	Cause	Solution
Motor stops too quickly.	Decel Time (P18/CFN17) set too short.	Increase Decel Time.
	Decel Begin and End Levels (P16/CFN15 and P17/CFN16) set improperly.	Increase Decel Begin and/or Decel End levels.
Decel time seems correct but motor surges (oscillates) at beginning of deceleration cycle.	Decel Begin Level (P16/CFN15) set too high.	Decrease Decel Begin Level until surging is eliminated.
Decel time seems correct but motor stops before end of deceleration cycle.	Decel End Level (P17/CFN16) set too low.	Increase Decel End Level until motor just stops at the end of the deceleration cycle.
Water hammer still occurs at end of cycle.	Decel End Level (P17/CFN16) set too high.	Decrease Decel End Level until water hammer is eliminated.
	Decel Time (P18/CFN17) too short.	If possible, increase Decel Time to decelerate system more gently.
Motor speed drops sharply before decel	Decel begin level too low.	Increase the Decel Begin Level until drop in speed is eliminated.

8.3.5 Motor stops unexpectedly while running

Condition	Cause	Solution
Fault Displayed.	Fault Occurred.	See fault code troubleshooting table for more details.
Ready Displayed.	Start command lost.	Verify start command input signal is present or serial communications start command is present.
		Check any permissive that may be wired into the run command. (Start/Stop)
Display Blank, Heartbeat LED on MX ² card not blinking.	Control voltage absent.	Check for proper control voltage input. Verify wiring and fuses.
	MX ² control card problem.	Consult factory.

8 - TROUBLESHOOTING & MAINTENANCE

8.3.6 Metering incorrect

Condition	Cause	Solution
Power Metering not reading correctly.	CTs installed or wired incorrectly.	Verify correct CT wiring and verify that the CTs are installed with all the White dots towards the input line side. CT1=L1 CT2=L2 CT3=L3
	CT ratio parameter (P78/FUN03) set incorrectly.	Verify that the CT ratio parameter is set correctly.
PF Meter not reading correctly.	CTs installed or wired incorrectly.	Verify correct CT wiring and verify that the CTs are installed with all the White dots towards the input line side.
Motor Current or Voltage meters fluctuating with steady load.	Energy Saver active.	Turn off Energy Saver if not desired.
	Loose connections.	Shut off all power and check all connections.
	SCR fault.	Verify that the SCRs gate leads are connected properly and the SCRs are ok.
	Load actually is not steady.	Verify that the load is actually steady and that there are not mechanical issues.
	Other equipment on same power feed causing power fluctuations and/or distortion.	Fix cause of power fluctuations and/or distortion.
Voltage Metering not reading correctly.	In medium voltage systems, Rated Voltage parameter (P76/FUN05) set incorrectly.	Verify that Rated Voltage parameter is set correctly.
Current Metering not reading correctly.	CT ratio parameter (P78/FUN03) set incorrectly.	Verify that the CT ratio parameter is set correctly.
	CTs installed or wired incorrectly.	Verify correct CT wiring and verify that the CTs are installed with all the White dots towards the input line side. CT1=L1 CT2=L2 CT3=L3
Ground Fault Current Metering not reading correctly.	CT ratio parameter (P78/FUN03) set incorrectly.	Verify that the CT ratio parameter is set correctly.
	CTs installed or wired incorrectly.	Verify correct CT wiring and verify that the CTs are installed with all the White dots towards the input line side. CT1=L1 CT2=L2 CT3=L3

8 - TROUBLESHOOTING & MAINTENANCE

8.3.7 Other Situations

Condition	Cause	Solution
Motor Rotates in Wrong Direction.	Phasing incorrect.	If input phasing correct, exchange any two output wires.
		If input phasing incorrect, exchange any two input wires.
Erratic Operation.	Loose connections.	Shut off all power and check all connections.
Motor Overheats.	Motor overloaded.	Reduce motor load.
	Too many starts per hour.	Allow for adequate motor cooling between starts. Set Hot/Cold ratio higher or lengthen cooling time.
	High ambient temperature.	Reduce ambient temperature or provide for better cooling. Set OL class lower to compensate for ambient temperature.
	Acceleration time too long.	Reduce starting load and/or review acceleration ramp settings.
	Incorrect motor OL settings.	Review and correct motor OL settings.
	Motor cooling obstructed/damaged.	Remove cooling air obstructions. Check motor cooling fan.
Starter cooling fans do not operate. (When Present)	Fan power supply lost.	Verify fan power supply, check fuses.
	Fan wiring problem.	Check fan wiring.
	Fan failure.	Replace fan.
Analog Output not functioning properly.	Voltage/Current output switch(SWI-2) not set correctly.	Set switch SW1 to give correct output.
	Wiring problem.	Verify output wiring.
	Analog Output Function parameter (P60/ I/O12) set incorrectly.	Verify that the Analog Output Function parameter is set correctly.
	Analog Output Offset and/or Span parameters (P61/ I/O13 and P62/ I/O14) set incorrectly.	Verify that the Analog Output Span and Offset parameters are set correctly.
	Load on analog output too high.	Verify that load on analog output meets the MX ² analog output specifications.
	Ground loop or noise problems.	Verify correct grounding of analog output connection to prevent noise and/or ground loops from affecting output.
Remote Keypad does not operate correctly.	Keypad cable not plugged in properly or cable is damaged.	Verify that the remote keypad cable has not been damaged and that it is properly seated at both the keypad and the MX ² control card.
	Remote display damaged.	Replace remote display.
Cannot change parameters.	Passcode is set.	Clear passcode.
	Starter is running.	Stop starter.
	Modbus is overriding.	Stop communications.
	Heater Level (P73 / FUN08) parameter is "On"	Turn Heater Level (P73 / FUN08) parameter "Off"

8 - TROUBLESHOOTING & MAINTENANCE

Fault Code Table

8.4 Fault Code Table

The following is a list of possible faults that can be generated by the MX² starter control.

Fault Code	Description	Detailed Description of Fault / Possible Solutions
F01	UTS Time Limit Expired	Motor did not achieve full speed before the UTS timer (P9/QST09) expired.
		Check motor for jammed or overloaded condition.
		Verify that the combined kick time (P14/CFN11) and acceleration ramp time (P8/QST08) is shorter than the UTS timer setting.
		Evaluate acceleration ramp settings. The acceleration ramp settings may be too low to permit the motor to start and achieve full speed. If so, revise acceleration ramp settings to provide more motor torque during starting.
		Evaluate UTS timer setting and, if acceptable, increase UTS timer setting (P9/QST09).
F02	Motor Thermal Overload Trip	Check motor for mechanical failure, jammed, or overloaded condition.
		Verify the motor thermal overload parameter settings (P3/QST03 and P44-P47/PFN12-PFN16,) and motor service factor setting (P2/QST02).
		Verify that the motor FLA (P1/QST01) and CT ratio (P78/FUN03) are correct.
		If motor OL trip occurs during starting, review acceleration ramp profile settings.
		Verify that there is not an input line power quality problem or excessive line distortion present.
F03	Slow Speed Timer Limit Expired	Increase Slow Speed Time Limit (P29/CFN23)
F10	Phase Rotation Error, not ABC	Input phase rotation is not ABC and Input Phase Sensitivity parameter (P77/FUN04) is set to ABC only.
		Verify correct phase rotation of input power. Correct wiring if necessary.
		Verify correct setting of Input Phase Sensitivity parameter (P77/FUN04).
F11	Phase Rotation Error, not CBA	Input phase rotation is not CBA and Input Phase Sensitivity parameter (P77/FUN04) is set to CBA only.
		Verify correct phase rotation of input power. Correct wiring if necessary.
		Verify correct setting of Input Phase Sensitivity parameter (P77/FUN04).
F12	Low Line Frequency	Line frequency below 23 Hz was detected.
		Verify input line frequency.
		If operating on a generator, check generator speed governor for malfunctions.
		Check input supply for open fuses or open connections.
		Line power quality problem / excessive line distortion..

8 - TROUBLESHOOTING & MAINTENANCE

Fault Code	Description	Detailed Description of Fault / Possible Solutions
F13	High Line Frequency	Line frequency above 72 Hz was detected.
		Verify input line frequency.
		If operating on a generator, check generator speed governor for malfunctions.
		Line power quality problem / excessive line distortion.
F14	Input power not single phase	Three-phase power has been detected when the starter is expecting single-phase power.
		Verify that input power is single phase.
		Verify that single-phase power is connected to the L1 and L3 inputs. Correct wiring if necessary.
		Verify that the SCR gate wires are properly connected to the MX ² control card.
F15	Input power not three phase	Single-phase power has been detected when the starter is expecting three-phase power.
		Verify that input power is three phase. Correct wiring if necessary.
		Verify that the SCR gate wires are properly connected to the MX ² control card.
		On medium voltage systems, verify wiring of the voltage feedback measurement circuit.
F21	Low Line L1-L2	Low voltage below the Under voltage Trip Level parameter setting (P39/PFN08) was detected for longer than the Over/Under Voltage Trip delay time (P40/PFN09).
		Verify that the actual input voltage level is correct.
		Verify that the Rated Voltage parameter (P76/FUN05) is set correctly.
		Check input supply for open fuses or open connections.
		On medium voltage systems, verify wiring of the voltage measurement circuit.
F22	Low Line L2-L3	Low voltage below the Under voltage Trip Level parameter setting (P39/PFN08) was detected for longer than the Over/Under Voltage Trip delay time (P40/PFN09).
		Verify that the actual input voltage level is correct.
		Verify that the Rated Voltage parameter (P76/FUN05) is set correctly.
		Check input supply for open fuses or open connections.
		On medium voltage systems, verify wiring of the voltage feedback measurement circuit.
F23	Low Line L3-L1	Low voltage below the Under voltage Trip Level parameter setting (P39/PFN08) was detected for longer than the Over/Under Voltage Trip delay time (P40/PFN09).
		Verify that the actual input voltage level is correct.
		Verify that the Rated Voltage parameter (P76/FUN05) is set correctly.
		Check input supply for open fuses or open connections.
		On medium voltage systems, verify wiring of the voltage feedback measurement circuit.

8 - TROUBLESHOOTING & MAINTENANCE

Fault Code	Description	Detailed Description of Fault / Possible Solutions
F24	High Line L1-L2	High voltage above the Over voltage Trip Level parameter setting (P35/PFN07) was detected for longer than the Over/Under Voltage Trip delay time (P40/PFN09).
		Verify that the actual input voltage level is correct.
		Verify that the Rated Voltage parameter (P76/FUN05) is set correctly.
		Line power quality problems/ excessive line distortions.
F25	High Line L2-L3	High voltage above the Over voltage Trip Level parameter setting (P38/PFN07) was detected for longer than the Over/Under Voltage Trip delay time (P40/PFN09).
		Verify that the actual input voltage level is correct.
		Verify that the Rated Voltage parameter (P76/FUN05) is set correctly.
		Line power quality problems/ excessive line distortions.
F26	High Line L3-L1	High voltage above the Over voltage Trip Level parameter setting (P38/PFN07) was detected for longer than the Over/Under Voltage Trip delay time (P40/PFN09).
		Verify that the actual input voltage level is correct.
		Verify that the Rated Voltage parameter (P76/FUN05) is set correctly.
		Line power quality problems/ excessive line distortions.
F27	Phase Loss	The MX ² has detected the loss of one or more input or output phases when the starter was running. Can also be caused by line power dropouts.
		Check input supply for open fuses.
		Check power supply wiring for open or intermittent connections.
		Check motor wiring for open or intermittent connections.
		On medium voltage systems, verify wiring of the voltage feedback measurement circuit.
		Check Gate and Cathode connections to MX ² card.
F28	No Line	No input voltage was detected for longer than the Inline Configuration time delay parameter setting (P63/ I/O16) when a start command was given to the starter.
		If an inline contactor is being used, verify that the setting of the Inline Configuration time delay parameter (P53/ I/O16) allows enough time for the inline contactor to completely close.
		Check input supply for open disconnects, open fuses, open circuit breakers or disconnected wiring.
		Verify that the SCR gate wires are properly connected to the MX ² control card.
		On medium voltage systems, verify wiring of the voltage feedback measurement circuit.

8 - TROUBLESHOOTING & MAINTENANCE

Fault Code	Description	Detailed Description of Fault / Possible Solutions
F30	I.O.C. (Instantaneous Over current)	During operation, the MX ² detected a very high level of current in one or more phases.
		Check motor wiring for short circuits or ground faults.
		Check motor for short circuits or ground faults.
		Check if power factor or surge capacitors are installed on the motor side of the starter.
		Verify that the motor FLA (P1/QST01) and CT ratio (P78/FUN03) settings are correct.
F31	Overcurrent	<p>Motor current exceeded the Over Current Trip Level setting (P32/PFN01) for longer than the Over Current Trip Delay Time setting (P33/PFN02).</p> <p>Check motor for a jammed or an overload condition.</p>
F34	Undercurrent	<p>Motor current dropped under the Under Current Trip Level setting (P26/PFN03) for longer than the Under Current Trip Delay time setting (P27/PFN04).</p> <p>Check system for cause of under current condition.</p>
F37	Current Imbalance	<p>A current imbalance larger than the Current Imbalance Trip Level parameter setting (P36/PFN05) was present for longer than ten (10) seconds.</p> <p>Check motor wiring for cause of imbalance. (Verify dual voltage and 6 lead motors for correct wiring configuration).</p> <p>Check for large input voltage imbalances that can result in large current imbalances.</p> <p>Check motor for internal problems.</p>
F38	Ground Fault	<p>Ground current above the Ground Fault Trip level setting (P37/PFN06) has been detected for longer than 3 seconds.</p> <p>Check motor wiring for ground faults.</p> <p>Check motor for ground faults.</p> <p>Megger motor and cabling (disconnect from starter before testing).</p> <p>Verify that the motor FLA (P1/QST01) and CT ratio (P78/FUN03) settings are correct.</p> <p>Verify that the CTs are installed with all the White dots towards the input line.</p> <p>In Single phase applications, verify that only two CTs are being used; that they are installed with all the White dots or Xs in the correct direction; and that the CTs are connected to the L1 and L3 CT inputs on the MX² control card.</p>
F39	No Current at Run	<p>Motor current went below 10% of FLA while the starter was running.</p> <p>Verify Motor Connections.</p> <p>Verify the CT wiring to the MX² control card.</p> <p>Verify that the motor FLA (P1/QST01) and CT ratio (P78.FUN03) settings are correct.</p> <p>Check if load is still connected to starter.</p> <p>Check if motor may have been driven by the load (a regeneration condition).</p> <p>Check Gate and Cathode connections to MX² for loose connections.</p> <p>Check for inline contactor or disconnect.</p>

8 - TROUBLESHOOTING & MAINTENANCE

Fault Code	Description	Detailed Description of Fault / Possible Solutions
F40	Shorted / Open SCR	A shorted or open SCR condition has been detected.
		Verify that all SCR gate leads wires are properly connected at the SCR devices and the MX ² control card.
		Check all SCRs with ohmmeter for shorts.
		Verify that the Input Phase Sensitivity parameter setting (P77/FUN04) is correct.
		Verify that the Starter Type parameter setting (P74/FUN07) is correct.
		Verify the motor wiring. (Verify dual voltage motors for correct wiring configuration).
F41	Current at Stop	Motor current was detected while the starter was not running.
		Examine starter for shorted SCRs.
		Examine bypass contactor (if present) to verify that it is open when starter is stopped.
		Verify that the motor FLA (P1/QST01) and CT ratio (P78/FUN03) settings are correct.
F46	Disconnect Fault	A signal on the disconnect digital input was not present when a start was commanded.
		Verify that disconnect feedback wiring is correct.
		Verify that the disconnect is not faulty.
F47	Stack Protection Fault (stack thermal overload)	The MX ² electronic power stack OL protection has detected an overload condition.
		Check motor for jammed or overloaded condition.
		Verify that the CT ratio (P78/FUN03) and burden switch settings are correct.
		Motor load exceeds power stack rating. Consult factory
F48	Bypass /2M Contactor Fault	An incorrect bypass feedback has been detected for longer than the Bypass Confirm time parameter setting (P64/ I/O17).
		Verify that the bypass/2M contactor coil and feedback wiring is correct.
		Verify that the relay connected to the bypass/2M contactor(s) is programmed as the UTS function.
		Verify that the bypass/2M contactor power supply is present.
		Verify that the appropriate Digital Input Configuration parameter has been programmed correctly.
		Verify that the bypass contactor(s) are not damaged or faulty.
F49	Inline Contactor Fault	Verify that the appropriate Digital Input Configuration parameter has been programmed correctly.
		Verify that the inline contactor(s) are actually not damaged or faulty.
F50	Control Power Low	Low control power (below 90V) has been detected while running.
		Verify that the control power input level is correct, especially during starting when there may be significant line voltage drop.
		Check control power transformer tap setting (if available).
		Check control power transformer fuses (if present).
		Check wiring between control power source and starter.

8 - TROUBLESHOOTING & MAINTENANCE

Fault Code	Description	Detailed Description of Fault / Possible Solutions
F51	Current Sensor Offset Error	Indicates that the MX ² control card self-diagnostics have detected a problem with one or more of the current sensor inputs.
		Verify that the motor FLA (P1/QST01), CT ratio (P78/FUN03) and burden switch settings are correct.
		Verify that no actual current is flowing through any of the starter's CTs when the starter is not running.
		Consult factory if fault persists.
F54	BIST Fault	The starter has detected a voltage or a current. Remove line power from input of starter. Disconnect must be open.
F55	BIST CT Fault	Verify CT location, CT1 on L1, CT2 on L2, CT3 on L3. or CTs are connected backwards (the polarity dot must be facing the supply line).
F60	External Fault on DI#1 Input	DI#1 has been programmed as a fault type digital input and the input indicates a fault condition is present.
		Verify that the appropriate Digital Input Configuration parameter has been programmed correctly.
		Verify wiring and level of input.
F61	External Fault on DI#2 Input	DI#2 has been programmed as a fault type digital input and input indicates a fault condition is present.
		Verify that the appropriate Digital Input Configuration parameter has been programmed correctly.
		Verify wiring and level of input.
F62	External Fault on DI#3 input	DI#3 input has been programmed as a fault type digital input and input indicates a fault condition is present.
		Verify that the appropriate Digital Input Configuration parameter has been programmed correctly.
		Verify wiring and level of input.
F71	Analog Input Level Fault Trip	Based on the Analog Input parameter settings, the analog input level has either exceeded or dropped below the Analog Input Trip Level setting (P56/ I/O 09) for longer than the Analog Input Trip Delay time (P57/ I/O 010).
		Measure value of analog input to verify correct reading.
		Verify settings of all Analog Input parameters (P55-P59/ I/O 08- I/O 12).
		Verify correct positioning of input switch (SW1) (Voltage or Current) on the MX ² control card.
		Verify correct grounding of analog input connection to prevent noise or ground loops from affecting input.
F81	Keypad Communication Fault	Indicates that communication has been lost with the remote keypad. (This fault normally occurs if the remote keypad is disconnected while the MX ² control card is powered up. Only connect and disconnect a remote keypad when the control power is off).
		Verify that the remote keypad cable has not been damaged and that its connectors are firmly seated at both the keypad and the MX ² control card.
		Verify that the display interface card (when present) is firmly attached to MX ² control card.
		Route keypad cables away from high power and/or high noise areas to reduce possible electrical noise pickup.

8 - TROUBLESHOOTING & MAINTENANCE

F82	Modbus Timeout Fault	Indicates that the starter has lost serial communications. Fault occurs when the starter has not received a valid serial communications within the Communication Timeout parameter (FUN12) defined time.
		Verify communication parameter settings (FUN 10 - FUN13).
		Check wiring between the remote network and the MX ² control card.
		Examine remote system for cause of communication loss
F94	CPU Error - SW Fault	Typically occurs when attempting to run a version of control software that is incompatible with the MX ² control card hardware being used. Verify that the software is a correct version for the MX ² control card being used. Consult factory for more details.
		Fault can also occur if the MX ² control has detected an internal software problem. Replace card.
F95	CPU Error - Parameter EEPROM Checksum Fault	The MX ² found the non-volatile parameter values to be corrupted. Typically occurs when the MX ² is re-flashed with new software.
		Perform a Factory Parameter reset (FUN 15) and then properly set all parameters before resuming normal operation.
		If fault persists after performing a Factory Parameter reset, replace card.
F96	CPU Error	The MX ³ has detected an internal CPU problem. Replace card.
F97	CPU Error – SW Watchdog Fault	The MX ³ has detected an internal software problem. Replace card.
F98	CPU Error	The MX ³ has detected an internal CPU problem. Replace card.
F99	CPU Error - Program EPROM Checksum Fault	The non-volatile program memory has been corrupted.
		Replace card. Control software must be reloaded in to MX ² control card before normal operation can resume.

8.5 SCR Testing

8.5.1 Resistance

The SCRs in the starter can be checked with a standard ohmmeter to determine their condition.

Remove power from the starter before performing these checks.

- Check from L to T on each phase. The resistance should be over 50k ohms.
- Check between the gate leads for each SCR (red and white twisted pair).
The resistance should be from 8 to 50 ohms.

⚠ **NOTE:** The resistance measurements may not be within these values and the SCR may still be good. The checks are to determine if an SCR is shorted "L" to "T" or if the gate in an SCR is shorted or open. An SCR could also still be damaged even though the measurements are within the above specifications.

8.5.2 Voltage

When the starter is running, the operation of the SCRs can be confirmed with a voltmeter.

Extreme caution must be observed while performing these checks since the starter has lethal voltages applied while operating.

While the starter is running and up to speed, use an AC voltmeter, check the voltage from "L" to "T" of each phase. The voltage should be less than 1.5 Volts. If the starter has a bypass contactor, the voltage drop should be less than 0.3 volts.

Using a DC voltmeter, check between the gate leads for each SCR (red and white twisted pair). The voltage should be between 0.5 and 2.0 volts.

8.5.3 Integral Bypass

A voltage check from "L" to "T" of each phase of the RediStart starter should be performed every 6 months to confirm the bypass contactors are operating correctly.

Extreme caution must be observed while performing these checks since the starter has lethal voltages applied while operating.



While the starter is running and Up to Speed, use an AC voltmeter; check the voltage from "L" to "T" of each phase. The voltage drop across the contactor contacts should be less than 300mV. If greater than 300mV the integral bypass should be disassembled. It may be necessary to clean the contact tips or replace the contactor.

8 - TROUBLESHOOTING & MAINTENANCE

Built-In Self Test Functions

8.6 Built In Self Test Functions

The MX² has two built in self test (BIST) modes. The first test is the standard self test and is used to test many of the basic functions of the starter without line voltage being applied. The second test is a line powered test that is used to verify the current transformer's locations and connections and to test for shorted SCRs/power poles, open or non-firing SCRs/power poles, and ground fault conditions.

8.6.1 Standard BIST Tests:

(P67 / #7) / FUN 15 - Std BIST

The standard BIST tests are designed to be run with no line voltage applied to the starter. In selected low voltage systems where a disconnect switch is used, the Disconnect Switch must be opened before starting the standard tests. Standard BIST mode can be initiated by entering the appropriate value into P67 or FUN 15 - Misc Command user parameter.



CAUTION: In order to prevent back feeding of voltage through the control power transformer (if used), control power must be carefully applied to the MX² control card and contactors so that self testing can occur safely. In low voltage applications, the user must verify that the applied test control power cannot be fed backwards through the system. "Run/Test" isolation switches, test power plugs, and wiring diagrams are available from Benschaw.



CAUTION: In low voltage systems with an inline/isolation contactor. Before the inline test is performed verify that no line voltage is applied to the line side of the inline contactor. Otherwise when the inline test is performed the inline contactor will be energized, applying line voltage to the starter, and a BIST test fault will occur.

The standard BIST tests comprise of:

Programming / Test Instructions:

Step 1

LED Display

Go to P67 and press [ENTER].
Press [UP] button to #1 and press [ENTER].
Powered BIST test will commence.

LCD Display

Go to FUN 15- misc commands and press [ENTER].
Increment up to "Std BIST" and press [ENTER].
Std BIST test will commence.

```
FUN: Misc Command
15 Std BIST
```

⌘ **NOTE:** Designed to run with no line voltage applied to starter.

Step 2- RUN relay test and Inline Feedback Test:

In this test, the RUN assigned relays are cycled on and off once and the feedback from an inline contactor is verified. In order to have a valid inline contactor feedback, a digital input needs to be set to Inline Confirm and the input needs to be wired to an auxiliary contact of the inline contactor. The feedback is checked in both the open and closed state. If the feedback does not match the state of the RUN relay within the amount of time set by the Inline Config parameter an "Inline" fault will occur.

⌘ **NOTE:** If no digital input is assigned as an Inline Confirm input this test will always pass.

⌘ **NOTE:** If the Inline Config (I/O 16) parameter on page 118 is set to "Off" this test will be skipped.

LED Display

b ic (inline closed)
b io (inline open)

LCD Display (BIST Mode)

Inline Closed
Inline Open

```
BIST Mode
Inline Closed
```

```
BIST Mode
Inline Open
```

Step 3- UTS relay test and Bypass Feedback Test:

In this test, the dedicated bypass relay (if assigned) and the UTS assigned relays are cycled on and off once, and the feedback from a bypass contactor is verified. In order to have a valid bypass contactor feedback, the individual bypass input and any other inputs set to Bypass Confirm input needs to be wired to an auxiliary contact of the bypass contactor. The feedback is checked in both the open and closed state. If the feedback does not match the state of the UTS relay within the amount of time set by the Bypass Feedback parameter a "Bypass/2M Fault" will occur.

8 - TROUBLESHOOTING & MAINTENANCE

⌘ **NOTE:** If one dedicated bypass is set to "fan" and if no digital input are assigned as a Bypass Confirm input, this test will always pass.

LED Display

b bc (bypass closed)
b bo (bypass open)

LCD Display (BIST Mode)

Bypass Closed
Bypass Open

```
BIST Mode
Bypass Closed
```

```
BIST Mode
Bypass Open
```

Step 4– Sequential SCR gate firing (L1+, L1-, L2+, L2-, L3+, L3-):

In this test the SCR gate outputs are sequentially fired starting with the L1+ device(s) and ending with the L3- device(s). This test can be used to verify that the SCR gate leads are connected properly. In LV systems, the gate voltage can be verified using a DC voltage meter or oscilloscope. The voltage on each red and white wire pair should be between 0.5VDC and 2.0VDC.

LED Display

b 96 (gate 6 on)
b 93 (gate 3 on)
b 95 (gate 5 on)
b 92 (gate 2 on)
b 94 (gate 4 on)
b 91 (gate 1 on)

LCD Display (BIST Mode)

Gate 6 On
Gate 3 On
Gate 5 On
Gate 2 On
Gate 4 On
Gate 1 On

```
BIST Mode
Gate 6? On
```

Step 5– Simultaneous SCR gate firing:

In this test the SCR gate outputs are simultaneously fired (all gates on). This test can be used to verify that the SCR gate leads are connected properly. The gate voltage can be verified using a DC voltage meter or oscilloscope. The voltage on each red and white wire pair should be between 0.5VDC and 2.0VDC.

Pressing [ENTER] on the keypad at any time will abort the current test in progress and proceed to the next BIST test.

During the standard BIST tests if line voltage or phase current is detected, the MX² will immediately exit BIST mode and declare a "BIST Abnormal Exit" fault.

LED Display

b 9A (all gates on)

LCD Display

All Gates On

```
BIST Mode
All gates on
```

Step 6

LED Display

b-- (tests completed)

LCD Display

Tests completed

```
BIST Mode
Tests completed
```

8.6.2 Powered BIST Tests:

(P67 / #8) / FUN 15 - Powered BIST

The powered BIST tests are designed to be run with normal line voltage applied to the starter and a motor connected. Powered BIST verifies that the power poles are good, no ground faults exist, CTs are connected and positioned correctly and that the motor is connected. Powered BIST mode can be entered by entering the appropriate value into the FUN 15- Miscellaneous Command user parameter.

⌘ **NOTE:** The powered BIST test is only for use with SCR based reduced voltage soft starters. Powered BIST can not be used with wye-delta or ATL types of starters.

8 - TROUBLESHOOTING & MAINTENANCE

⌘ **NOTE:** The motor wiring **MUST** be fully connected before starting the powered BIST tests. Also the motor must be at rest (stopped). Otherwise the powered BIST tests will not function correctly.

⌘ **NOTE:** Before using the powered BIST test function, the following MX² user parameters **MUST** be set for correct operation of the powered BIST test: Motor FLA (P1 / QST 01), CT Ratio (P78 / FUN 03), Phase Order (P77 / FUN 04), Rated Voltage (P76 / FUN 05), and Starter Type (P74 / FUN 07).

The powered BIST tests comprise of:

Programming / Test Instructions:

Step 1

LED Display

Go to P67 and press [ENTER].
Press [UP] button to #2 and press [ENTER].
Powered BIST test will commence.

LCD Display

Go to FUN 15 and press [ENTER].
Increment up to "Powered BIST" and press [ENTER].
Powered BIST test will commence.

```
FUN: Misc Command
15 Powered BIST
```

Step 2– Shorted SCR and Ground Fault Test:

In this test each power pole is energized individually. If current flow is detected, the MX² controller attempts to differentiate whether it is a shorted SCR/shorted power pole condition or a ground fault condition and either a “Bad SCR Fault” or “Ground Fault” will occur.

LED Display

b 59 -(Gating individual SCRs)

LCD Display (BIST Mode)

Shorted SCR / GF

```
BIST Mode
Shorted SCR/GF
```

Step 3– Open SCR and Current Transformer (CT) Test:

In this test, a low-level closed-loop controlled current is selectively applied to various motor phases to verify that the motor is connected, all SCRs are turning on properly, and that the CTs are wired and positioned properly. If current is detected on the wrong phase then a “BIST CT Fault” fault will be declared. If an open motor lead, open SCR, or non-firing SCR is detected then a “Bad SCR Fault” will occur.

⌘ **NOTE:** When this test is in progress 6 audible humming or buzzing sounds will be heard from the motor.

LED Display

b oc

LCD Display (BIST Mode)

Open SCR / CTs

```
BIST Mode
Open SCR/CTs
```

Step 4

LED Display

b-- (tests completed)

LCD Display

Tests completed.

```
BIST Mode
Tests completed
```

Pressing [ENTER] on the keypad at any time will abort the current test in progress and proceed to the next BIST test.

⌘ **NOTE:** If line voltage is lost during the powered tests a “BIST Abnormal Exit” fault will occur.

⌘ **NOTE:** The powered BIST tests will verify that the input phase order is correct. If the measured phase order is not the same as the “Phase Order” (FUN 04) parameter a phase order fault will occur.

SCR Replacement

8.7 SCR Replacement

This section is to help with SCR replacements on stack assemblies. Please read prior to installation.

8.7.1 Typical Stack Assembly

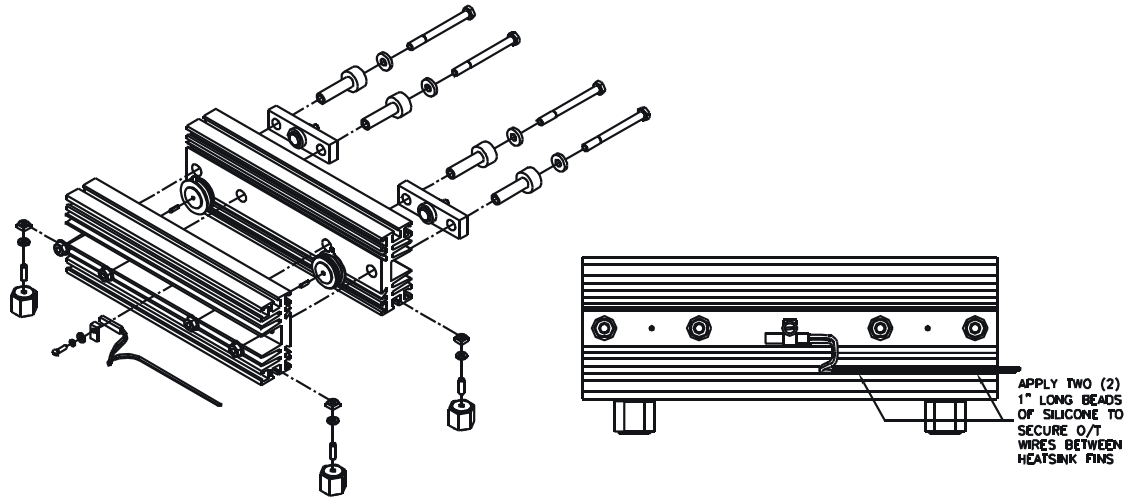

8.7.2 SCR Removal

To remove the SCR from the heatsink, loosen the two bolts (3) on the loader bar side of the clamp. Do not turn on the nuts (5). The nuts have a locking ridge that sink into the aluminum heatsink. Do $\frac{1}{4}$ turns until the SCR comes loose. Remove the SCR from the heatsink.

⚠ **NOTE:** Do not loosen nut on indicator washer (6). This will change the clamping pressure of the clamp and the clamp will be defective.

8.7.3 SCR Installation

- Coat the faces of the SCR to be installed with a thin layer of EJC (Electrical Joint Compound).
- Place the SCR onto the dowel pins. The top SCR will have the cathode to the left and the bottom SCR will have the cathode to the right. The SCR symbol has a triangle that points to the cathode.
- Finger tighten nuts on the bolts.

8 - TROUBLESHOOTING & MAINTENANCE

8.7.4 SCR Clamp

Below is an exploded view of a typical SCR clamp. Refer to the Clamp Parts List below for names of the parts being used.

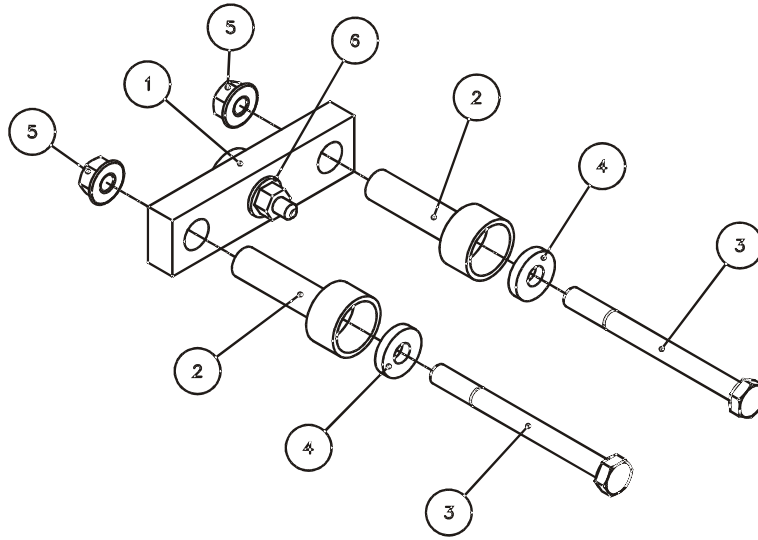

SCR CLAMP PARTS

Item #	Quantity	Description
1	1	Loader Bar
2	2	Insulator cup
3	2	Bolt
4	2	Washer
5	2	Serrated nut (larger style clamp has 1 support bar)
6	1 or 2	Indicator Washer – Quantity dependant on style of clamp

8.7.5 Tightening Clamp

Finger tighten the clamp. Ensure both bolts are tightened an equal amount so that the loader bar (item 1) is square in the heatsink. Tighten the bolts equally in 1/8 turn increments until the indicator washer(s) (item 6), which are under the nut(s) in the center of the loader bar, becomes loose indicating the clamp is tight. On the loader bars with two indicator washers, it may be necessary to tighten or loosen one side of the clamp to get both indicator washers free.

8.7.6 Testing SCR

After the SCRs have been replaced, conduct the resistance test as defined in section 8.5.

Appendices

APPENDIX A - ALARM CODES

Alarm Codes

The following is a list of all MX² alarm codes. The alarm codes correspond to associate fault codes. In general, an alarm indicates a condition that if continued, will result in the associated fault.

Alarm Code	Description	Notes
A02	Motor Overload Alarm	This occurs when the motor thermal content reaches the 90%. The MX ² trips when it reaches 100%. The alarm continues until the overload trip lockout is reset.
A10	Phase Rotation not ABC	This alarm exists while the MX ² is stopped, line voltage is detected and phase sensitivity parameter is set to ABC. If a start is commanded, a Fault 10 occurs.
A11	Phase Rotation not CBA	This alarm exists while the MX ² is stopped, line voltage is detected and phase sensitivity parameter is set to CBA. If a start is commanded, a Fault 11 occurs.
A12	Low Line Frequency	This alarm exists when the MX ² has detected a line frequency below the user defined low line frequency level. The alarm continues until either the line frequency changes to be in range or the fault delay timer expires.
A13	High Line Frequency	This alarm exists when the MX ² has detected a line frequency above the user defined high line frequency level. The alarm continues until either the line frequency changes to a valid frequency or the fault delay timer expires.
A14	Input power not single phase	This alarm exists while the MX ² is stopped, set to single phase mode, and line voltage is detected that is not single phase. If a start is commanded, a Fault 14 occurs.
A15	Input power not three phase	This alarm exists while the MX ² is stopped, set to a three-phase mode, and single-phase line voltage is detected. If a start is commanded, a Fault 15 occurs.
A21	Low Line L1-L2	This alarm exists while the MX ² is stopped and low line voltage is detected. If a start is commanded, a Fault 21 may occur.
A22	Low Line L2-L3	This alarm exists while the MX ² is stopped and low line voltage is detected. If a start is commanded, a Fault 22 may occur.
A23	Low Line L3-L1	This alarm exists while the MX ² is stopped and low line voltage is detected. If a start is commanded, a Fault 23 may occur.
A24	High Line L1-L2	This alarm exists while the MX ² is stopped and high line voltage is detected. If a start is commanded, a Fault 24 may occur.
A25	High Line L2-L3	This alarm exists while the MX ² is stopped and high line voltage is detected. If a start is commanded, a Fault 25 may occur.
A26	High Line L3-L1	This alarm exists while the MX ² is stopped and high line voltage is detected. If a start is commanded, a Fault 26 may occur.
A27	Phase Loss	This alarm exists while the MX ² is running and a phase loss condition is detected, but the delay for the fault has not yet expired. When the delay expires, a Fault 27 occurs.
A28	No Line	This alarm exists while the MX ² needs to be synchronized or is trying to sync to the line and no line is detected.
A31	Overcurrent	This alarm exists while the MX ² is running and the average current is above the defined threshold, but the delay for the fault has not yet expired. When the delay expires, a Fault 31 occurs.
A34	Undercurrent	This alarm exists while the MX ² is running and the average current is below the defined threshold, but the delay for the fault has not yet expired. When the delay expires, a Fault 34 occurs.
A37	Current Imbalance	This alarm exists while the MX ² is running and a current imbalance above the defined threshold is detected, but the delay for the fault has not yet expired. When the delay expires, a Fault 37 occurs.

APPENDIX A - ALARM CODES

Alarm Code	Description	Notes
A38	Ground Fault	This alarm exists while the MX ² is running and a ground current above the defined threshold is detected, but the delay for the fault has not yet expired. When the delay expires, a Fault 38 occurs.
A47	Stack Over temperature Alarm	This occurs when the stack thermal rises above 105%.
A60	External Alarm on DI 1 Input	This occurs when a digital input is in its fault state but before the fault state has expired.
A61	External Alarm on DI 2 Input	
A62	External Alarm on DI 3 Input	
A71	Analog Input Level Trip Alarm	This alarm exists if the analog input exceeds the defined threshold, but the delay for the fault has not yet expired. When the delay expires, a Fault 71 occurs.

APPENDIX B - FAULT CODES

Fault Codes

Fault Code	Description	Controlled Fault Stop	Shunt Trip Fault	Auto-Reset Allowed
F00	No fault	-	-	-
F01	UTS Time Limit Expired	Y	N	Y
F02	Motor Thermal Overload Trip	Y	N	Y
F03	Slow Speed Time Limit Expired	N	N	N
F10	Phase Rotation Error, not ABC	N	N	Y
F11	Phase Rotation Error, not CBA	N	N	Y
F12	Low Line Frequency	N	N	Y
F13	High Line Frequency	N	N	Y
F14	Input power not single phase	N	N	Y
F15	Input power not three phase	N	N	Y
F21	Low Line L1-L2	Y	N	Y
F22	Low Line L2-L3	Y	N	Y
F23	Low Line L3-L1	Y	N	Y
F24	High Line L1-L2	Y	N	Y
F25	High Line L2-L3	Y	N	Y
F26	High Line L3-L1	Y	N	Y
F27	Phase Loss	N	N	Y
F28	No Line	N	N	Y
F30	I.O.C.	N	Y	N
F31	Overcurrent	Y	N	Y
F34	Undercurrent	Y	N	Y
F37	Current Imbalance	Y	N	Y
F38	Ground Fault	N	Y	Y
F39	No Current at Run	N	N	Y
F40	Shorted / Open SCR	N	Y	N
F41	Current at Stop	N	Y	N
F46	Disconnect Fault	N	Y	N
F47	Stack Protection Fault (stack thermal overload)	N	N	Y
F48	Bypass/2M Contactor Fault	Y	N	N
F49	Inline Contactor Fault	Y	N	N
F50	Control Power Low	N	N	Y
F51	Current Sensor Offset Error	N	Y	N
F54	BIST Fault	N	N	N
F55	BIST CT Fault	N	N	N
F60	External Fault on DI 1 Input	N	N	Y
F61	External Fault on DI 2 Input	N	N	Y
F62	External Fault on DI 3 Input	N	N	Y
F71	Analog Input #1 Level Fault Trip	Y	N	Y
F81	Keypad Communication Fault	Y	N	N
F82	Modbus Timeout Fault	Y	N	Y
F94	CPU Error – SW fault	N	N	N
F95	CPU Error – Parameter EEPROM Checksum Fault	N	N	N
F96	CPU Error	N	Y	N
F97	CPU Error - SW Watchdog	N	Y	N
F98	CPU Error	N	N	N
F99	CPU Error – Program EPROM Checksum Fault	N	N	N

APPENDIX C - SPARE PARTS

Options and Accessories

	Description	Part Number	Size
1)	LCD Display (small)	KPMX3SLCD	H=63mm (2.48"), W=101mm (4")
2)	LCD Display (large)	KPMX3LLCD	H=77mm (3.03"), W=127mm (5")
3)	LCD display cable	RI-100008-00 RI-100009-00	3' or 1 meter 6' or 2 meter
4)	Communication Modules	-consult factory	

Spare Parts

	Description	Part Number	Size	Quantity
1)	LCD Display	small = KPMX3SLCD	H=63mm (2.48"), W=101mm (4")	
		large = KPMX3LLCD	H=77mm (3.03"), W=127mm (5")	
2)	LCD Display Cable	short = RI-100008-00 long = RI-100009-00	3' or 1m 6' or 2m	
3)	Cooling Fans		4" – 6"	
4)	Stack O/T Switch			3
5)	Current Transformer (CTs)	CT288:1 CT864:1 CT2640:1 CT5760:1	288:1 864:1 2640:1 5760:1	
6)	MX ² card	PC-300055-01-05		
7)	DV/DT Board	PC-300048-01-02		3
8)	Control Power Transformers	VA & Voltage specific		
9)	SCRs	BISCR5016x BISCR10016x BISCR13216x BISCR16116x BISCR25016x		3 / Starter
		BISCR66018x BISCR88018x BISCR150018x		6 / Starter
10)	Contactors	RSC-9-6AC120 RSC-100-4120 RSC-12-6AC120 RSC-125-4120 RSC-18-6AC120 RSC-150-4120 RSC-22-6AC120 RSC-180-4120 RSC-32-6AC120 RSC-220-4120 RSC-40-6AC120 RSC-300-4120 RSC-50-6AC120 RSC-400-4120 RSC-75-6AC120 RSC-600-4120 RSC-85-6AC120 RSC-800-4120 RSC-85/4-6AC-120		

APPENDIX D - EU DECLARATION OF CONFORMITY

EU Declaration of Conformity

According to the EMC – Directive 89/336/EEC as Amended by 92/31/EEC and 93/68/EEC

Product Category: Motor Controller
Product Type: Reduced Voltage Solid State Motor Controller
Model Number:

RB2-1-S-027A-11C	RB2-1-S-096A-13C	RB2-1-S-240A-15C	RB2-1-S-515A-17C
RB2-1-S-040A-11C	RB2-1-S-125A-14C	RB2-1-S-302A-15C	RB2-1-S-590A-18C
RB2-1-S-052A-12C	RB2-1-S-156A-14C	RB2-1-S-361A-16C	RB2-1-S-720A-19C
RB2-1-S-065A-12C	RB2-1-S-180A-14C	RB2-1-S-414A-17C	RB2-1-S-838A-20C
RB2-1-S-077A-13C	RB2-1-S-180A-15C	RB2-1-S-477A-17C	
RC2-1-S-096A-13C	RC2-1-S-240A-15C	RC2-1-S-515A-17C	
RC2-1-S-125A-14C	RC2-1-S-302A-15C	RC2-1-S-590A-18C	
RC2-1-S-156A-14C	RC2-1-S-361A-16C	RC2-1-S-720A-19C	
RC2-1-S-180A-14C	RC2-1-S-414A-17C	RC2-1-S-838A-20C	
RC2-1-S-180A-15C	RC2-1-S-477A-17C		

Manufacturer's Name: Benshaw, Inc.
Manufacturer's Address: 1659 East Sutter Road
Glenshaw, PA 15116
United States of America

The before mentioned products comply with the following EU directives and Standards:

Safety: UL 508 Standard for Industrial Control Equipment covering devices for starting, stopping, regulating, controlling, or protecting electric motors with ratings of 1500 volts or less.

Electromagnetic Compatibility: EN 50081-2 Emissions Radiated/Conducted
EN 55011/05.98+A1:1999
EN 50082-2 Immunity/Susceptibility which includes:
EN 61000-4-2 Electrostatic Discharge
EN 61000-4-3 Radiated RF
EN 61000-4-4 Electrical Fast Transient/Burst
EN 61000-4-6 Injected Currents

The products referenced above are for the use of control of the speed of AC motors. The use in residential and commercial premises (Class B) requires an optional EMC series filter. Via internal mechanisms and Quality Control, it is verified that these products conform to the requirements of the Directive and applicable standards.

Glenshaw, PA USA - 1 December 2006

Neil Abrams
Quality Control
Manager

APPENDIX E - MODBUS REGISTER MAP

Modbus Register Map

Following is the Modbus Register Map. Note that all information may be accessed either through the Input registers (30000 addresses) or through the Holding registers (40000 addresses).

Absolute Register Address	Description	Range	Units
30020/40020	Starter Control	Bit Mask: Bit 0: Run/Stop Bit 1: Fault Reset Bit 2: Emergency Overload Reset Bit 3: Local/Remote Bit 4: Heat Disable Bit 5: Ramp Select Bit 10: Reserved (Relay 6) Bit 11: Reserved (Relay 5) Bit 12: Reserved (Relay 4) Bit 13: Relay 3 Bit 14: Relay 2 Bit 15: Relay 1	-
30021/40021	Starter Status	Bit Mask: Bit 0: Ready Bit 1: Running Bit 2: UTS Bit 3: Alarm Bit 4: Fault Bit 5: Lockout	-
30022/40022	Input Status	Bit Mask: Bit 0: Start Bit 1: DI 1 Bit 2: DI 2 Bit 3: DI 3	-
30023/40023	Alarm Status 1	Bit Mask: Bit 0: "A 0L" – Motor overload Bit 1: "A 5" – Reserved (Motor PTC) Bit 2: "A 6" – Reserved (Stator RTD) Bit 3: "A 7" – Reserved (Bearing RTD) Bit 4: "A 8" – Reserved (Other RTD) Bit 5: "A 10" – Phase rotation not ABC Bit 6: "A 11" – Phase rotation not CBA Bit 7: "A 12" – Low Line Frequency Bit 8: "A 13" – High Line Frequency Bit 9: "A 14" – Phase rotation not 1PH Bit 10: "A 15" – Phase rotation not 3PH Bit 11: "A 21" – Low line L1-L2 Bit 12: "A 22" – Low line L2-L3 Bit 13: "A 23" – Low line L3-L1 Bit 14: "A 24" – High line L1-L2 Bit 15: "A 25" – High line L2-L3	-
30024/40024	Alarm Status 2	Bit 0: "A 26" – High line L3-L1 Bit 1: "A 27" – Phase loss Bit 2: "noL" – No line Bit 3: "A 29" – PORT Timeout (reserved) Bit 4: "A 31" – Overcurrent Bit 5: "A 34" – Undercurrent Bit 6: "A 35" – PF Too Leading (reserved) Bit 7: "A 36" – PF Too Lagging (reserved) Bit 8: "A 37" – Current imbalance Bit 9: "A 38" – Ground fault Bit 10: "A 47" – Stack overtemperature Bit 11: "A 53" – Tach Loss (reserved) Bit 12: "A 60" – DI 1 Bit 13: "A 61" – DI 2 Bit 14: "A 62" – DI 3 Bit 15: "A 63" – Reserved (DI 4)	-
30025/40025	Alarm Status 3	Bit 0: "A 64" – Reserved (DI 5) Bit 1: "A 65" – Reserved (DI 6) Bit 2: "A 66" – Reserved (DI 7) Bit 3: "A 67" – Reserved (DI 8) Bit 4: "A 71" – Analog Input #1 Trip	-

APPENDIX E - MODBUS REGISTER MAP

Absolute Register Address	Description	Range	Units
30026/40026	Lockout Status	Bit 0: "L OL" – Motor overload Bit 1: – Reserved - (Motor PTC) Bit 2: – Reserved - (RTD Stator) Bit 3: – Reserved - (RTD Bearing) Bit 4: – Reserved - (RTD Other) Bit 5: "L rI" – Run Interlock Bit 6: "L dS" – Disconnect open Bit 7: "L Ot" – Stack overtemperature Bit 8: "L CP" – Control Power Bit 9: Reserved – (RTD Open/Short) Bit 10: Reserved – (Time between starts) Bit 11: Reserved – (Backspin) Bit 12: Reserved – (Starts per hour) Bit 13: Reserved – (RTD Comm Loss)	-
30027/40027	Present Fault Code		
30028/40028	Average Current		A _{rms}
30029/40029	L1 Current		A _{rms}
30030/40030	L2 Current		A _{rms}
30031/40031	L3 Current		A _{rms}
30032/40032	Current Imbalance		0.1 %
30033/40033	Residual Ground Fault Current		% FLA
30034/40034	Reserved		-
30035/40035	Average Voltage		V _{rms}
30036/40036	L1-L2 Voltage		V _{rms}
30037/40037	L2-L3 Voltage		V _{rms}
30038/40038	L3-L1 Voltage		V _{rms}
30039/40039	Motor Overload		%
30040/40040	Power Factor	-99 to +100 (in 16-bit two's compliment signed format)	0.01
30041/40041	Watts (lower 16 bits)		W
30042/40042	Watts (upper 16 bits)	(in 32-bit unsigned integer format)	
30043/40043	VA (lower 16 bits)		VA
30044/40044	VA (upper 16 bits)	(in 32-bit unsigned integer format)	
30045/40045	vars (lower 16 bits)		var
30046/40046	vars (upper 16 bits)	(in 32-bit two's compliment signed integer format)	
30047/40047	kW hours (lower 16 bits)		kWh
30048/40048	kW hours (upper 16 bits)	(in 32-bit unsigned integer format)	
30049/40049	Phase Order	0: no line 1: ABC 2: CBA 3: SPH	-
30050/40050	Line Frequency	230 – 720, or 0 if no line	0.1 Hz
30051/40051	Analog Input %	-1000 to +1000 (in 16-bit two's compliment signed format)	0.1 %
30052/40052	Analog Output %	0 – 1000	0.1 %
30053/40053	Running Time	0 – 65535	hours
30054/40054	Running Time	0 – 59	minutes
30055/40055	Starts		-
30056/40056	TruTorque %		%
30057/40057	Power %		%
30058/40058	Peak Starting Current		A _{rms}
30059/40059	Last Starting Duration		0.1 Sec
30101/40101	Motor FLA	1 – 6400	A _{rms}
30102/40102	Motor Service Factor	100 – 199	0.01
30103/40103	Independent Start/Run Motor Overloads	0: Disabled 1: Enabled	-

APPENDIX E - MODBUS REGISTER MAP

Absolute Register Address	Description	Range	Units
30104/40104	Motor Overload Running Enable	0: Disabled 1: Enabled	-
30105/40105	Motor Overload Running Class	1 – 40	-
30106/40106	Motor Overload Starting Enable	0: Disabled 1: Enabled	-
30107/40107	Motor Overload Starting Class	1 – 40	
30108/40108	Motor Overload Hot/Cold Ratio	0 – 99	%
30109/40109	Motor Overload Cooling Time	10 – 9999	0.1 Min
30110/40110	Local Source	0: Keypad 1: Terminal 2: Serial	-
30111/40111	Remote Source		
30112/40112	Start Mode	0: Open Loop Voltage Ramp 1: Closed Loop Current Ramp 2: TruTorque Ramp 3: Power Ramp	-
30113/40113	Initial Motor Current 1	50 – 600	% FLA
30114/40114	Maximum Motor Current 1	100 – 800	% FLA
30115/40115	Ramp Time 1	0 – 300	Sec
30116/40116	Initial Motor Current 2	50 – 600	% FLA
30117/40117	Maximum Motor Current 2	100 – 800	% FLA
30118/40118	Ramp Time 2	0 – 300	Sec
30119/40119	UTS Time	1 – 900	Sec
30120/40120	Initial V/T/P	1 – 100	%
30121/40121	Max T/P	10 – 325	%
30122/40122	Stop Mode	0: Coast 1: Voltage Decel 2: TruTorqu Decel 3: DC Brake	-
30123/40123	Decel Begin Level	100 – 1	%
30124/40124	Decel End Level	99 – 1	%
30125/40125	Decel Time	1 – 180	Sec
30126/40126	DC Brake Level	10 – 100	%
30127/40127	DC Brake Time	1 – 180	Sec
30128/40128	DC Brake Delay	1 – 30	100 mSec
30129/40129	Kick Enable 1	0: Disabled 1: Enabled	-
30130/40130	Kick Current Level 1	100 – 800	% FLA
30131/40131	Kick Time 1	1 – 100	100 mSec
30132/40132	Kick Enable 2	0: Disabled 1: Enabled	-
30133/40133	Kick Current Level 2	100 – 800	% FLA
30134/40134	Kick Time 2	1 – 100	100 mSec
30135/40135	Slow Speed Enable	0: Disabled 1: Enabled	-
30136/40136	Slow Speed	0: 7.1 1: 14.3	%
30137/40137	Slow Speed Current Level	10 – 400	% FLA
30138/40138	Slow Speed Time Limit Enable	0: Disabled 1: Enabled	-
30139/40139	Slow Speed Time Limit	1 – 900	Sec
30140/40140	Slow Speed Kick Enable	0: Disabled 1: Enabled	-
30141/40141	Slow Speed Kick Level	100 – 800	% FLA
30142/40142	Slow Speed Kick Time	1 – 100	100 mSec

APPENDIX E - MODBUS REGISTER MAP

Absolute Register Address	Description	Range	Units
30143/40143	Rated RMS Voltage	0: 100 1: 110 2: 120 3: 200 4: 208 5: 220 6: 230 7: 240 8: 350 9: 380 10: 400 11: 415 12: 440 13: 460 14: 480 15: 500 16: 525 17: 575 18: 600 19: 660 20: 690 21: 800 22: 1000 23: 1140	Vrms
30144/40144	Input Phase Sensitivity	0: Ins 1: ABC 2: CBA 3: SPH	-
30145/40145	Motor Rated Power Factor	1 – 100	-
30146/40146	Overcurrent Enable	0: Disabled 1: Enabled	-
30147/40147	Overcurrent Level	50 – 800	% FLA
30148/40148	Overcurrent Delay Time Enable	0: Disabled 1: Enabled	-
30149/40149	Overcurrent Delay Time	1 – 900	100 mSec
30150/40150	Undercurrent Trip Enable	0: Disabled 1: Enabled	-
30151/40151	Undercurrent Trip Level	5 – 100	% FLA
30152/40152	Undercurrent Trip Delay Time Enable	0: Disabled 1: Enabled	-
30153/40153	Undercurrent Trip Delay Time	1 – 900	100 mSec
30154/40154	Current Imbalance Trip Enable	0: Disabled 1: Enabled	-
30155/40155	Current Imbalance Trip Level	5 – 40	%
30156/40156	Residual Ground Fault Trip Enable	0: Disabled 1: Enabled	-
30157/40157	Residual Ground Fault Trip Level	5 – 100	% FLA
30158/40158	Over Voltage Trip Enable	0: Disabled 1: Enabled	-
30159/40159	Over Voltage Trip Level	1 – 40	%
30160/40160	Under Voltage Trip Enable	0: Disabled 1: Enabled	-
30161/40161	Under Voltage Trip Level	1 – 40	%
30162/40162	Over/Under Voltage Delay Time	1 – 900	100 mSec
30163/40163	Digital Input Trip Delay Time	1 – 900	100 mSec
30164/40164	Auto Fault Reset Enable	0: Disabled 1: Enabled	-
30165/40165	Auto Fault Reset Delay Time	1 – 900	Sec
30166/40166	Auto Fault Reset Count Enable	0: Disabled 1: Enabled	-
30167/40167	Auto Fault Reset Count	1 – 10	-

APPENDIX E - MODBUS REGISTER MAP

Absolute Register Address	Description	Range	Units
30168/40168	Controlled Fault Stop	0: Disabled 1: Enabled	-
30169/40169	DI 1 Configuration	0: Off	
30170/40170	DI 2 Configuration	1: Stop	
30171/40171	DI 3 Configuration	2: Fault High 3: Fault Low 4: Fault Reset 5: Disconnect 6: Inline Feedback (F49) 7: Bypass / 2M Feedback (F48) 8: Emergency Motor OL Reset 9: Local / Remote Control Source 10: Heat Disable 11: Heat Enable 12: Ramp Select 13: Slow Speed Forward 14: Slow Speed Reverse 15: DC Brake Disable 16: DC Brake Enable 17: Run Enable 18: Run Disable	
30172/40172	R1 Configuration	0: Off	
30173/40173	R2 Configuration	1: Fault Fail Safe	
30174/40174	R3 Configuration	2: Fault Non Fail Safe 3: Running 4: Up To Speed 5: Alarm 6: Ready 7: Locked Out 8: Over Current Alarm 9: Under Current Alarm 10: Overload Alarm 11: Shunt Trip Fail Safe 12: Shunt Trip Non Fail Safe 13: Faulted on Ground Fault 14: In Energy Saver Mode 15: Heating 16: Slow Speed 17: Slow Speed Forward 18: Slow Speed Reverse 19: DC Braking 20: Cooling Fan	
30175/40175	Analog Input Trip Enable	0: Disabled 1: Enabled	-
30176/40176	Analog Input Trip Type	0: Low – Fault below preset level 1: High – Fault above preset level	-
30177/40177	Analog Input Trip Level	0 – 100	%
30178/40178	Analog Input Trip Delay Time	1 – 900	100 mSec
30179/40179	Analog Input Span	1 – 100	%
30180/40180	Analog Input Offset	0 – 99	%
30181/40181	Analog Output Function	0: Off (no output) 1: 0 – 100% Current 2: 0 – 200% Current 3: 0 – 800% Current 4: 0 – 150% Voltage 5: 0 – 150% Overload 6: 0 – 10kW 7: 0 – 100kW 8: 0 – 1MW 9: 0 – 10MW 10: 1 – 100% Analog Input 11: 0 – 100% Firing 12: Calibration (full output)	-
30182/40182	Analog Output Span	1 – 125	%
30183/40183	Analog Output Offset	0 – 99	%

APPENDIX E - MODBUS REGISTER MAP

Absolute Register Address	Description	Range	Units
30184/40184	Inline Enable	0: Disabled 1: Enabled	-
30185/40185	Inline Delay Time	10 – 100	100 mSec
30186/40186	Bypass Feedback Time	1 – 50	100 mSec
30187/40187	Keypad Stop	0: Disabled 1: Enabled	-
30188/40188	Modbus Timeout Enable	0: Disabled 1: Enabled	-
30189/40189	Modbus Timeout	1 – 120	Sec
30190/40190	CT Ratio (x:1)	0: 72:1 1: 96:1 2: 144:1 3: 288:1 4: 864:1 5: 2640:1 6: 3900:1 7: 5760:1 8: 8000:1 9: 14400:1 10: 28800:1	-
30191/40191	Auto Start	0: Disabled 1: Start after power applied 2: Start after fault reset 3: Start after power applied and after fault reset	-
30192/40192	Energy Saver Enable	0: Disabled 1: Enabled	-
30193/40193	Heater / Anti-Windmill Enable	0: Disabled 1: Enabled	-
30194/40194	Heater / Anti-Windmill Level	1 – 25	% FLA
30195/40195	Starter Type	0: Normal (Outside Delta) 1: Inside Delta 2: Wye-Delta 3: Phase Controller 4: Current Follower 5: Across the Line (Full Voltage)	-
30196/40196	LED Display Meter	0: Status 1: Ave Current 2: L1 Current 3: L2 Current 4: L3 Current 5: Current Imbalance % 6: Residual Ground Fault 7: Ave. Volts 8: L1-L2 Volts 9: L2-L3 Volts 10: L3-L1 Volts 11: Overload 12: Power Factor 13: Watts 14: VA 15: vars 16: kW hours 17: MW hours 18: Phase Order 19: Line Frequency 20: Analog Input 21: Analog Output 22: Running Days 23: Running Hours 24: Starts 25: TruTorque % 26: Power % 27: Peak Starting Current 28: Last Starting Duration	-

APPENDIX E - MODBUS REGISTER MAP

Absolute Register Address	Description	Range	Units
30197/40197	LCD Display Meter 1	1: Ave Current 2: L1 Current 3: L2 Current 4: L3 Current 5: Current Imbalance % 6: Residual Ground Current 7: Ave. Volts 8: L1-L2 Volts 9: L2-L3 Volts 10: L3-L1 Volts 11: Overload 12: Power Factor 13: Watts 14: VA 15: vars 16: kW hours 17: MW hours 18: Phase Order 19: Line Frequency 20: Analog Input 21: Analog Output 22: Running Days 23: Running Hours 24: Starts 25: TruTorque % 26: Power % 27: Peak Starting Current 28: Last Starting Duration	
30198/40198	LCD Display Meter 2		
30199/40199	Misc. Commands	0: None 1: Standard BIST 2: Powered BIST 3: Reset Run Time 4: Reset kWh 5: Enter Reflash Mode 6: Store Parameters 7: Load Parameters 8: Factory Reset	
30200/40200	Bypass Feedback Enable	0: Disabled 1: Enabled	
30601/40601 (most recent) to 30609/40609 (oldest)	Fault Codes	Refer to page 196.	
30611/40611 (most recent) to 30619/40619 (oldest)	System States	0: Initializing 1: Locked Out 2: Faulted 3: Stopped 4: Heating 5: Kicking 6: Ramping 7: Slow Speed 8: Not UTS 9: UTS 10: Phase Control / Current Follower 11: Decelerating 12: Braking 13: Wye 14: PORT 15: BIST 16: Shorted SCR Test 17: Open SCR Test	
30621/40621 (most recent) to 30629/40629 (oldest)	L1 Currents: The current that the load is drawing from Line 1 when the fault has occurred.		Arms
30631/40631 (most recent) to 30639/40639 (oldest)	L2 Currents: The current that the load is drawing from Line 2 when the fault has occurred.		Arms

APPENDIX E - MODBUS REGISTER MAP

Absolute Register Address	Description	Range	Units
30641/40641 (most recent) to 30649/40649 (oldest)	L3 Currents: The current that the load is drawing from Line 3 when the fault has occurred.		Arms
30651/40651 (most recent) to 30659/40659 (oldest)	L1-L2 Voltages: The line voltage that is present between lines 1 and 2 when a fault occurs.		Vrms
30661/40661 (most recent) to 30669/40669 (oldest)	L2-L3 Voltages: The line voltage that is present between lines 2 and 3 when a fault occurs.		Vrms
30671/40671 (most recent) to 30679/40679 (oldest)	L3-L1 Voltages: The line voltage that is present between lines 3 and 1 when a fault occurs.		Vrms
30681/40681 (most recent) to 30689/40689 (oldest)	Kilowatts: The power that the load is drawing when a fault occurs.		KW
30691/40691 (most recent) to 30699/40699 (oldest)	Line Periods: The line period (1/frequency) that is present when a fault occurs.		microseconds
30701/40701 (most recent) to 30709/40709 (oldest)	Run Time Hours: The value of the running time meter when a fault occurs.		Hours

Diagnostics

These registers provide some diagnostics capabilities for testing and controlling the communications link.

Absolute Register Address	Description	Range	Units
31201/41201	Parameter Changed Flag	0: Not Changed 1: Changed	-
31202/41202	Modbus Address	1 – 247	-
31203/41203	Baud Rate	0: 1200 1: 2400 2: 4800 3: 9600 4: 19200	bps
31204/41204	Byte Framing	0: 1 Stop Bit, Even Parity 1: 1 Stop Bit, Odd Parity 2: 1 Stop Bit, No Parity 3: 2 Stop Bits, No Parity	-
31205/41205	Modbus Messages Received		-
31206/41206	Scratch		-

APPENDIX E - MODBUS REGISTER MAP

The control source must be serial for the starter to be started through Modbus. The Run/Stop bit must transition from 0 to 1 for a start to occur. If the starter stops due to a fault, the action of the starter depends on the state of the AutoStart parameter (P66 – I/O19).

The fault reset bit must transition from 0 to 1 for a fault to be reset.

If any of the programmed digital inputs are programmed as Local/Remote inputs, then the local/Remote bit has no effect.

When the relays are programmed as “Off”, the relay bits may be written in order to control the relays. When the relays are programmed for any function other than “Off” (Fault, Run, UTS for example), then the relay bits may be read to determine the state of the relays.

Starter Status Register:

Bit 0 – Ready	0: Initializing or Faulted and Decelerating or Faulted and Braking or Faulted and Stopped or Lockout 1: Otherwise
Bit 1 – Running	0: Not Running 1: Running
Bit 2 –UTS	0: Not UTS 1: UTS
Bit 3 –Alarm	0: No alarm conditions 1: One or more alarm conditions
Bit 4 –Fault	0: No Fault Condition 1: Fault Condition
Bit 5 –Lockout	0: Start or Fault Reset not locked out. 1: Start or Fault Reset locked out. Possible causes are: Overload Lockout State

Watts, VA, vars, and kW hour Registers:

Meter registers present 32 bit meters in two consecutive 16 bit registers. The least significant 16 bits are in the first register followed by the most significant 16 bits in the second register.

Reading the least significant register latches data into the most significant register so that the data remains synchronized between the two.

Starter Control Register

Bit 0 – Run/Stop	0: Stop 1: Start
Bit 1 – Fault Reset	0: No action 1: Fault Reset
Bit 2 –Emergency Overload Reset	0: No action 1: Emergency Overload Reset
Bit 3 –Local/Remote	0: Local 1: Remote
Bit 4 –Heat Disabled	0: Heater Enabled 1: Heater Disabled
Bit 5 –Ramp Select	0: Ramp 1 1: Ramp 2
Bit 13 – Relay 3	0: Energize(d) 1: De-energize(d)
Bit 14 – Relay 2	Same as above
Bit 15 – Relay 1	Same as above

Parameter Registers

For those parameters that can be set either to "Off", or some value within a range (many of the protection parameters, for example) there are two Modbus registers. One is an "enable" register, and the other sets the value within the range.

APPENDIX F - PARAMETER TABLES

Parameter Table

Following is the parameter table for both the LED and LCD Display. The last column is a convenient place to write down parameter settings.

Quick Start Group

LED	LCD	Parameter	Setting Range	Units	Default	Page	Setting
P1	QST 01	Motor FLA	1 – 6400	RMS Amps	10	75	
P2	QST 02	Motor Service Factor	1.00 – 1.99		1.15	75	
P3	QST 03	Motor Running Overload Class	Off, 1 – 40		10	76	
P4	QST 04	Local Source	PA: Keypad tEr: Terminal SEr: Serial		Terminal	77	
P5	QST 05	Remote Source				78	
P6	QST 06	Initial Motor Current 1	50 – 600	%FLA	100	79	
P7	QST 07	Maximum Motor Current 1	100 – 800	%FLA	600	80	
P8	QST 08	Ramp Time 1	0 – 300	Seconds	15	81	
P9	QST 09	UTS Time / Transition Time	1 – 900	Seconds	20	82	

Control Function Group

LED	LCD	Parameter	Setting Range	Units	Default	Page	Setting
P10	CFN 01	Start Mode	oLrP: Voltage Ramp curr: Current Ramp tt: TT Ramp Pr: Power Ramp		Current Ramp	83	
P8	CFN 02	Ramp Time 1	0 – 300	Seconds	15	81	
P6	CFN 03	Initial Motor Current 1	50 – 600	%FLA	100	79	
P7	CFN 04	Maximum Motor Current 1	100 – 800	%FLA	600	80	
P24	CFN 05	Ramp Time 2	0 – 300	Seconds	15	94	
P22	CFN 06	Initial Motor Current 2	50 – 600	%FLA	100	93	
P23	CFN 07	Maximum Motor Current 2	100 – 800	%FLA	600	93	
P11	CFN 08	Initial Voltage/Torque/Power	1 – 100	%	25	84	
P12	CFN 09	Maximum Torque/Power	10 – 325	%	105	85	
P13	CFN 10	Kick Level 1	Off, 100 – 800	%FLA	Off	86	
P14	CFN 11	Kick Time 1	0.1 – 10.0	Seconds	1.0	86	
P25	CFN 12	Kick Level 2	Off, 100 – 800	%FLA	Off	94	
P26	CFN 13	Kick Time 2	0.1 – 10.0	Seconds	1.0	94	
P15	CFN 14	Stop Mode	CoS: Coast SdcL: Volt Decel TdcL: TT Decel dcb: DC Braking		Coast	87	
P16	CFN 15	Decel Begin Level	100 – 1	%	40	88	
P17	CFN 16	Decel End Level	99 – 1	%	20	89	
P18	CFN 17	Decel Time	1 – 180	Seconds	15	90	
P19	CFN 18	DC Brake Level	10 – 100	%	25	91	
P20	CFN 19	DC Brake Time	1-180	Seconds	5	92	
P21	CFN 20	DC Brake Delay	0.1-3.0	Seconds	0.2	93	
P27	CFN 21	Slow Speed	Off, 7.1, 14.3	%	Off	95	
P28	CFN 22	Slow Speed Current Level	10-400	% FLA	100	95	
P29	CFN 23	Slow Speed Timer	Off, 1-900	Seconds	10	96	
P30	CFN 24	Slow Speed Kick Level	Off, 100-800	% FLA	Off	96	
P31	CFN 25	Slow Speed Kick Time	0.1-10.0	Seconds	1.0	97	

APPENDIX F - PARAMETER TABLES

Protection Function Group

LED	LCD	Parameter	Setting Range	Units	Default	Page	Setting
P32	PFN 01	Over Current Level	Off, 50 – 800	% FLA	Off	98	
P33	PFN 02	Over Current Trip Delay Time	Off, 0.1 – 90.0	Seconds	0.1	99	
P34	PFN 03	Under Current Trip Level	Off, 5 – 100	% FLA	Off	100	
P35	PFN 04	Under Current Trip Delay Time	Off, 0.1 – 90.0	Seconds	0.1	100	
P36	PFN 05	Current Imbalance Trip Level	Off, 5 – 40	%	15	101	
P37	PFN 06	Residual Ground Fault Trip Level	Off, 5 – 100	%FLA	Off	102	
P38	PFN 07	Over Voltage Trip Level	Off, 1 – 40	%	Off	103	
P39	PFN 08	Under Voltage Trip Level	Off, 1 – 40	%	Off	103	
P40	PFN 09	Over/Under Voltage Trip Delay Time	0.1 – 90.0	Seconds	0.1	104	
P41	PFN 10	Auto Fault Reset Time	Off, 1 – 900	Seconds	Off	104	
P42	PFN 11	Auto Reset Count Limit	Off, 1-10		Off	104	
P43	PFN 12	Controlled Fault Stop	Off, On		On	105	
P44	PFN 13	Independent Starting/Running Overload	Off, On		Off	106	
P45	PFN 14	Motor Overload Class Starting	Off, 1 – 40		10	107	
See P3	PFN 15	Motor Overload Class Running	Off, 1 – 40		10	76	
P46	PFN 16	Motor Overload Hot/Cold Ratio	0 – 99	%	60	108	
P47	PFN 17	Motor Overload Cooling Time	1.0 – 999.9	Minutes	30.0	109	

I/O Group

LED	LCD	Parameter	Setting Range	Units	Default	Page	Setting
P48	I/O 01	DI 1 Configuration	OFF: Off STOP: Stop FH: Fault High FL: Fault Low Fr: Fault Reset diSc: Disconnect InLn: Inline Cnfrm		Stop	110	
P49	I/O 02	DI 2 Configuration	byP: Bypass Cnfrm EoLr: E OL Reset L-r: Local/Remote hdIS: Heat Disable hEn: Heat Enable rSEL: Ramp Select SS F: Slow Speed Forward		Off		
P50	I/O 03	DI 3 Configuration	SS r: Slow Speed Reverse BdIS: DC Brake Disable BEn : DC Brake Enable runE: Run Enable rund: Run Disable		Off		
P51	I/O 04	Digital Fault Input Trip Time	0.1-90.0	Seconds	0.1	111	

APPENDIX F - PARAMETER TABLES

LED	LCD	Parameter	Setting Range	Units	Default	Page	Setting
P52	I/O 05	R1 Configuration	OFF: Off FLFS: Fault (fail safe) FLnF: Fault (non fail safe) run: Running utS: UTS		Fault FS	112	
P53	I/O 06	R2 Configuration	AL: Alarm rdyr: Ready LOC: Locked Out OC: Over Current UC: Under Current		Off		
P54	I/O 07	R3 Configuration	OLA: OL Alarm ShFS: Shunt Trip (fail safe) ShnF: Shunt Trip (non fail safe) GfLt: Ground Fault ES: Energy Saver HEAt: Heating SSpd: Slow Speed SS F: Slow Speed Forward SS r: Slow Speed Reverse dcb: DC Braking FAn: Cooling Fan		Off		
P55	I/O 08	Analog Input Trip Type	OFF: Disabled Lo: Low Level Hi: High Level		Off	113	
P56	I/O 09	Analog Input Trip Level	0 – 100	%	50	114	
P57	I/O 10	Analog Input Trip Time	0.1 – 90.0	Seconds	0.1	114	
P58	I/O 11	Analog Input Span	1 – 100	%	100	115	
P59	I/O 12	Analog Input Offset	0 – 99	%	0	116	
P60	I/O 13	Analog Output Function	0: OFF (no output) 1: 0 – 100% Curr 2: 0 – 200% Curr 3: 0 – 800% Curr 4: 0 – 150% Volt 5: 0 – 150% OL 6: 0 – 10 kW 7: 0 – 100 kW 8: 0 – 1 MW 9: 0 – 10 MW 10: 0 – 100% Ain 11: 0 – 100% Firing 12: Calibration		Off	116	
P61	I/O 14	Analog Output Span	1 – 125	%	100	117	
P62	I/O 15	Analog Output Offset	0 – 99	%	0	117	
P63	I/O 16	Inline Configuration	Off, 1.0 – 10.0	Seconds	3.0	118	
P64	I/O 17	Bypass Feedback Time	Off, 0.1 – 5.0	Seconds	2.0	118	
P65	I/O 18	Keypad Stop Disable	Enabled, Disabled		Enabled	119	
P66	I/O 19	Power on Start Selection	0: Disabled 1: Start after Power applied only 2: Start after Fault reset only 3: Start after power applied and after fault reset.		Disabled	119	

APPENDIX F - PARAMETER TABLES

Function Group

LED	LCD	Parameter	Setting Range	Units	Default	Page	Setting
P79	FUN 01	Meter 1	0: Status 1: Ave Current 2: L1 Current 3: L2 Current 4: L3 Current 5: Curr Imbal 6: Residual Ground Fault 7: Ave Volts 8: L1-L2 Volts 9: L2-L3 Volts 10: L3-L1 Volts 11: Overload 12: Power Factor 13: Watts 14: VA		Ave Current	127	
	FUN 02	Meter 2	15: vars 16: kW hours 17: MW hours 18: Phase Order 19: Line Freq 20: Analog Input 21: Analog Output 22: Run Days 23: Run Hours 24: Starts 25: TruTorque % 26: Power % 27: Peak Starting Current 28: Last Starting Duration		Ave Volts	127	
P78	FUN 03	CT Ratio	72:1, 96:1, 144:1, 288:1, 864:1, 2640:1, 3900:1, 5760:1, 8000:1, 14400:1, 28800:1		288	126	
P77	FUN 04	Input Phase Sensitivity	InS Inensitive AbC ABC CbA CBA SPH Single Phase		Insens.	126	
P76	FUN 05	Rated RMS Voltage	100, 110, 120, 200, 208, 220, 230, 240, 350, 380, 400, 415, 440, 460, 480, 500, 525, 575, 600, 660, 690, 800, 1000, 1140,	RMS Voltage	480	125	
P75	FUN 06	Motor Rated Power Factor	-0.01 (Lag) – 1.00 (Unity)		-0.92	125	
P74	FUN 07	Starter Type	nor: Normal Id: Inside Delta y-d: Wye-Delta / Other Electro mechanical PctL: Phase Control cFol: Current Follower AtL: Full Voltage ATL		Normal	124	
P73	FUN 08	Heater Level	Off, 1 – 40	%FLA	Off	123	
P72	FUN 09	Energy Saver	Off, On		Off	122	
P70	FUN 10	Communication Address	1 – 247		1	121	
P69	FUN 11	Communication Baud Rate	1200 2400 4800 9600 19200	bps	19200	121	
P68	FUN 12	Communication Timeout	Off, 1 – 120	Seconds	Off	121	

APPENDIX F - PARAMETER TABLES

LED	LCD	Parameter	Setting Range	Units	Default	Page	Setting
P71	FUN 13	Communication Byte Framing	0: Even Parity, 1 Stop bit 1: Odd Parity, 1 Stop bit 2: No Parity, 1 Stop bit 3: No Parity, 2 Stop bits		Even Parity, 1 Stop bit	122	
P80	FUN 14	Software Version 1	Display Only			128	
P67	FUN 15	Miscellaneous Commands	0: None 1: Std. BIST 2: Powered BIST 3: Reset Run Time 4: Reset KWh/MWh 5: Enter Reflash mode 6: Store Parameters 7: Load Parameters 8: Factory Reset		None	120	
P81	FUN 16	Passcode			Off	129	

LCD Fault Group

Group	Fault Number	Fault Description	Starter State	I1	I2	I3	V1	V2	V3	kW	Hz	Run Time
FL1												
FL2												
FL3												
FL4												
FL5												
FL6												
FL7												
FL8												
FL9												

LED Fault Group

Group	Fault Number	Fault Description	Fault Number	Fault Description
F1			F6	
F2			F7	
F3			F8	
F4			F9	
F5				



BENSHAW
ADVANCED CONTROLS & DRIVES

BENSHAW
615 Alpha Drive
Pittsburgh, PA 15238
Phone: (412) 968-0100
Fax: (412) 968-5415

BENSHAW Canada
550 Bright Street
Listowel, Ontario N4W 3W3
Phone: (519) 291-5112
Fax: (519) 291-2595